

VASCA DOCCIA IDROMASSAGGIO

In questo manuale è illustrata la procedura di montaggio delle **vasche doccia combinate** ad angolo

Prima di montare la **vasca doccia** angolare consigliamo di consultare il presente manuale di istruzioni per realizzare il montaggio correttamente.

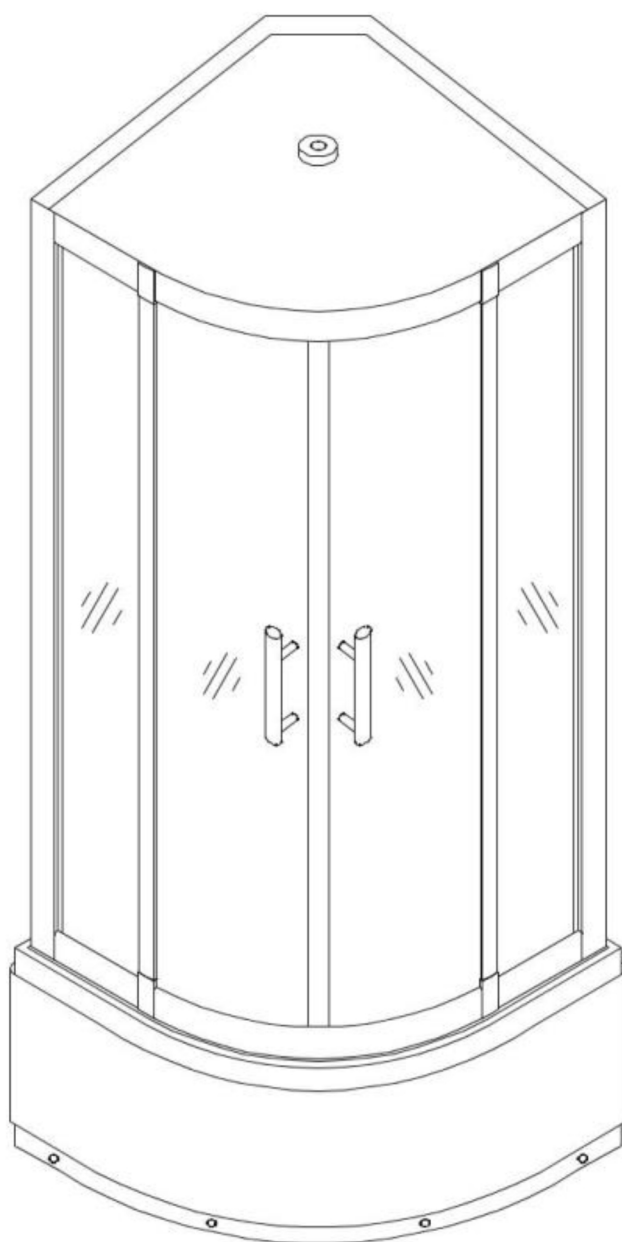

1/4

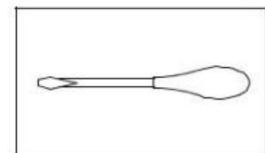
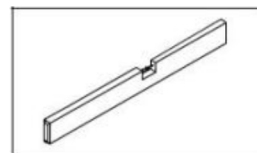
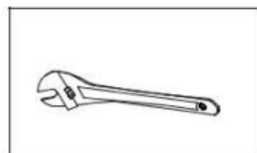
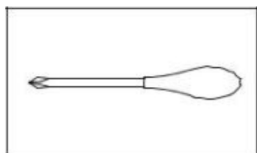
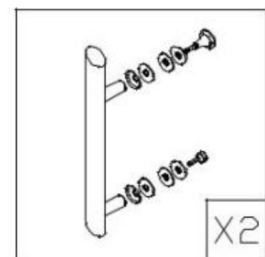
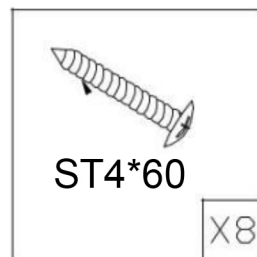
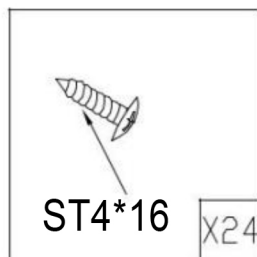
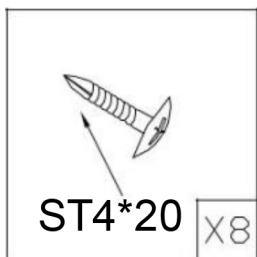
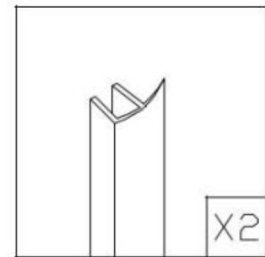
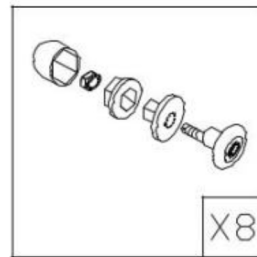
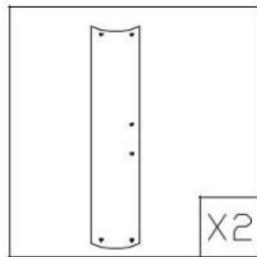
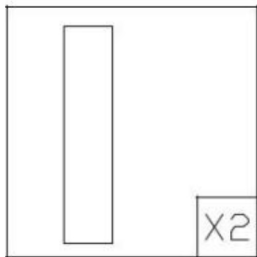
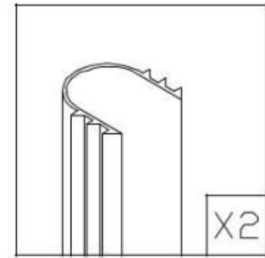
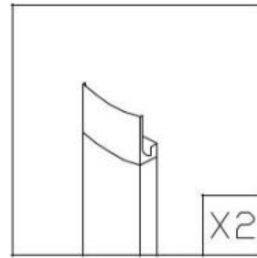
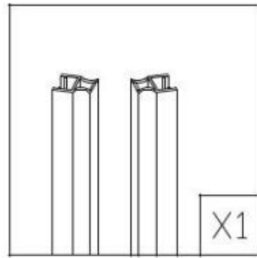
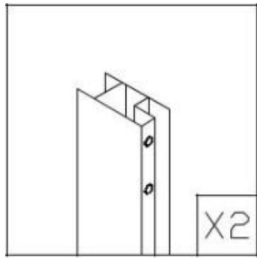
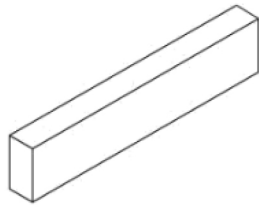

2/4

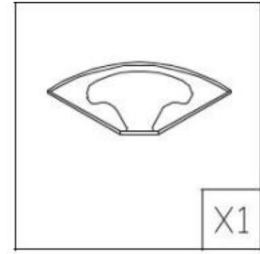
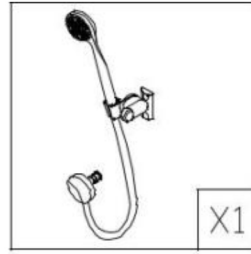
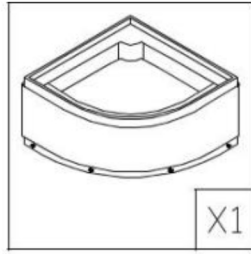
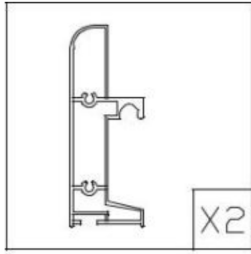
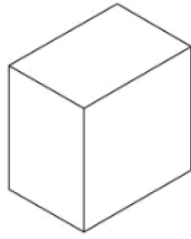

3/4

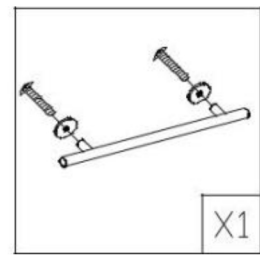
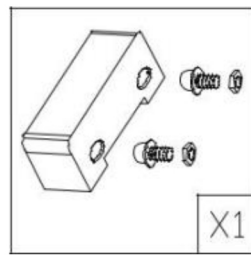
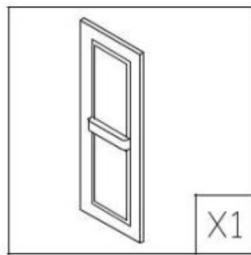
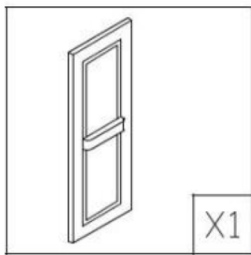
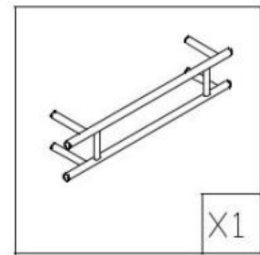
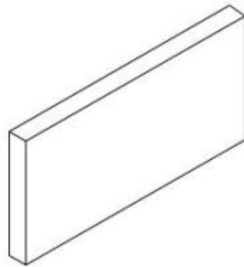

4/4

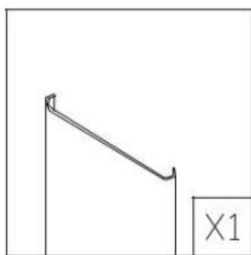
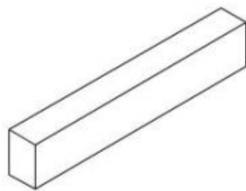

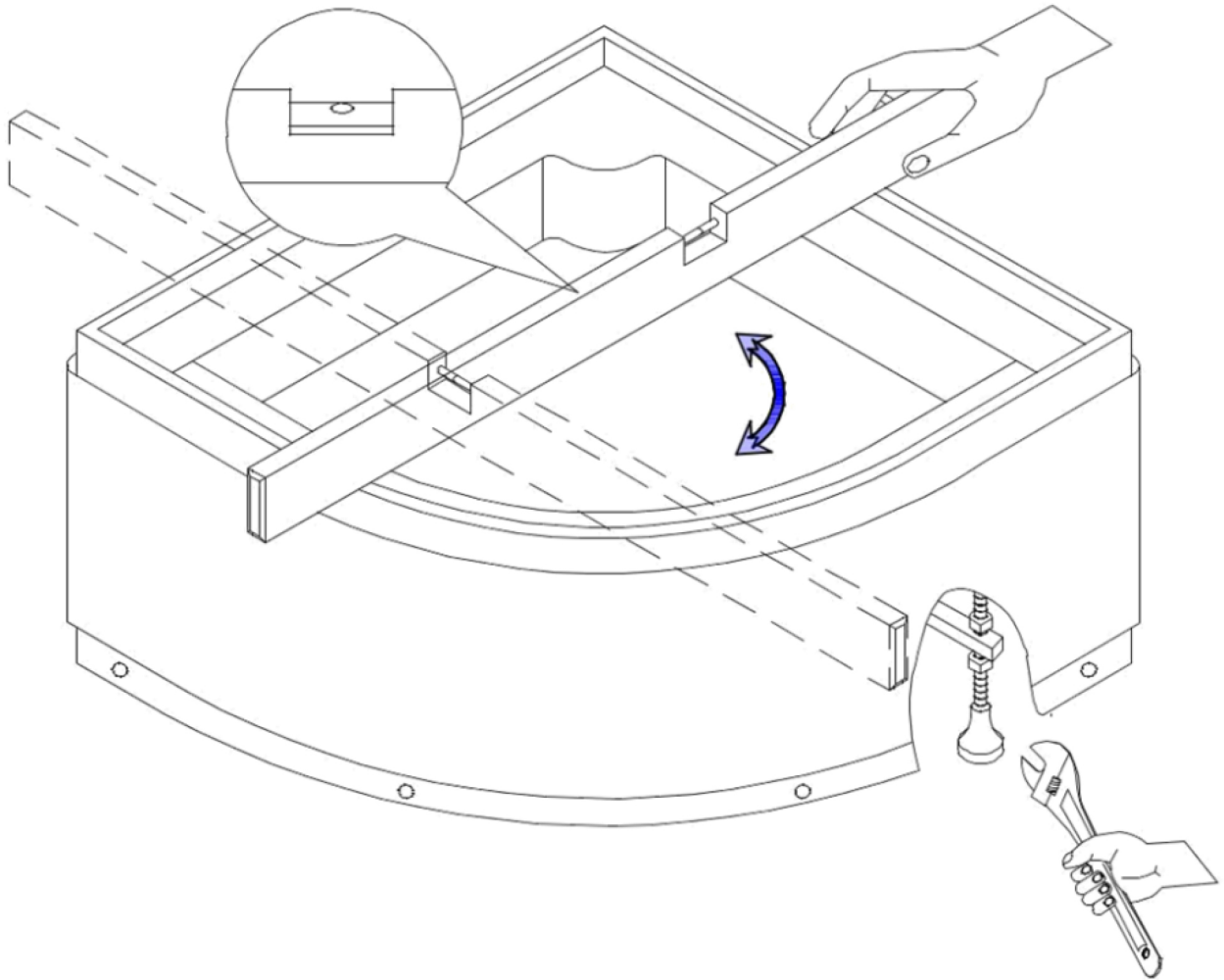
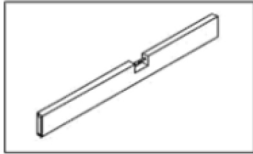
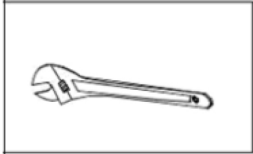

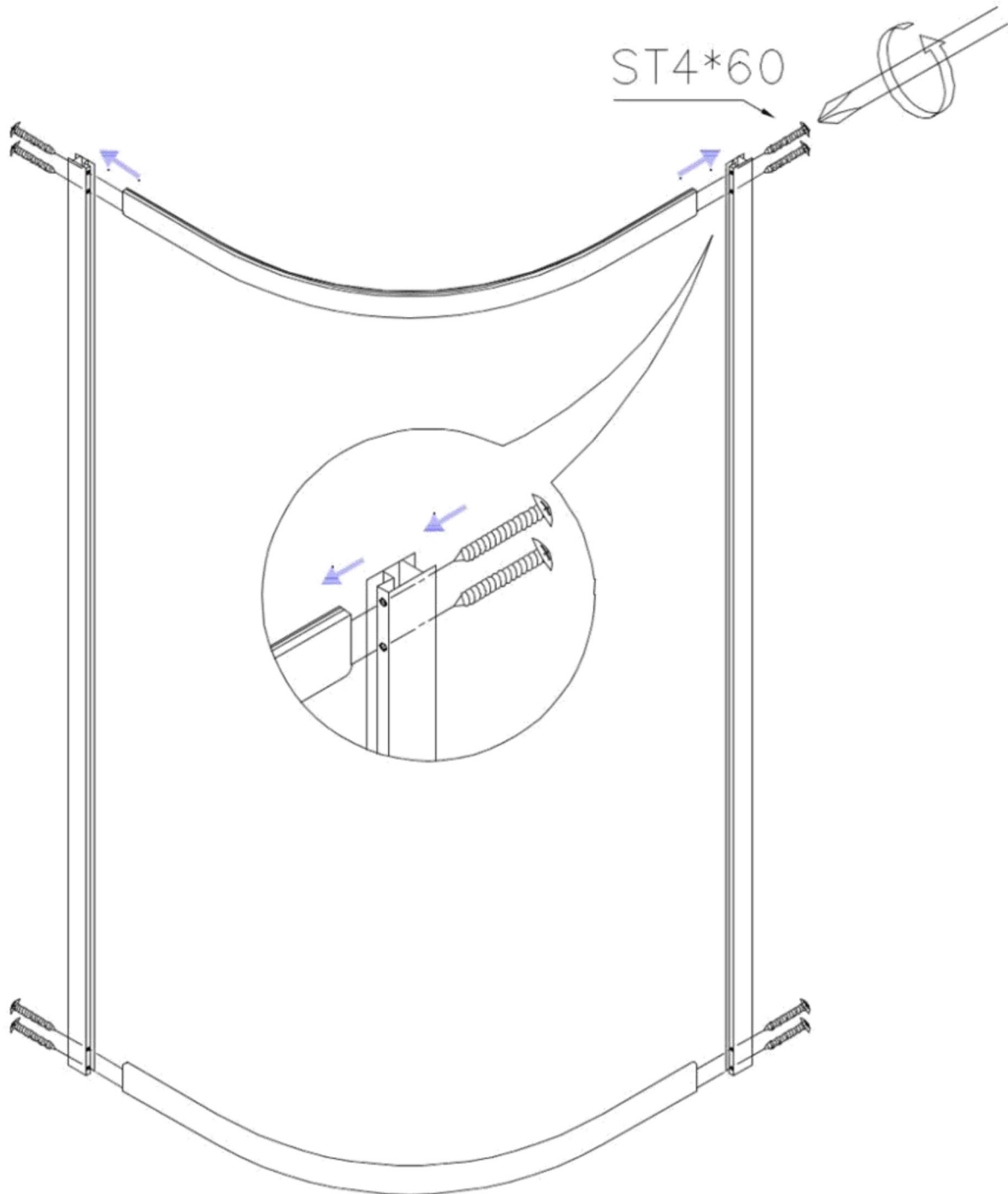
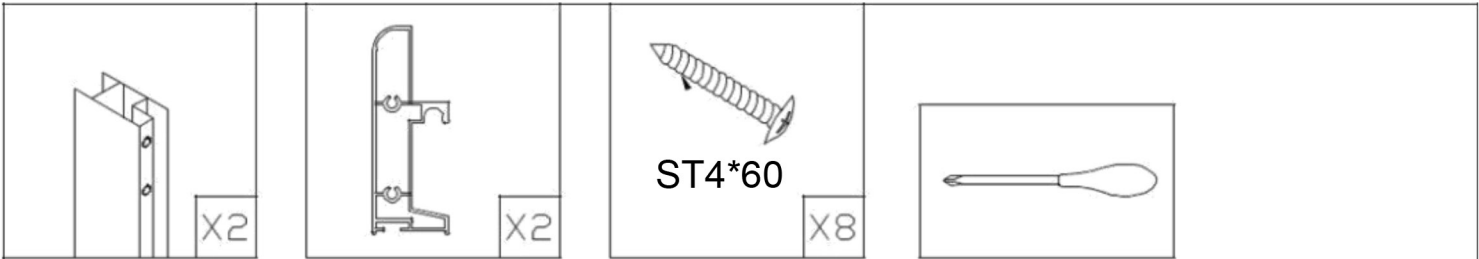

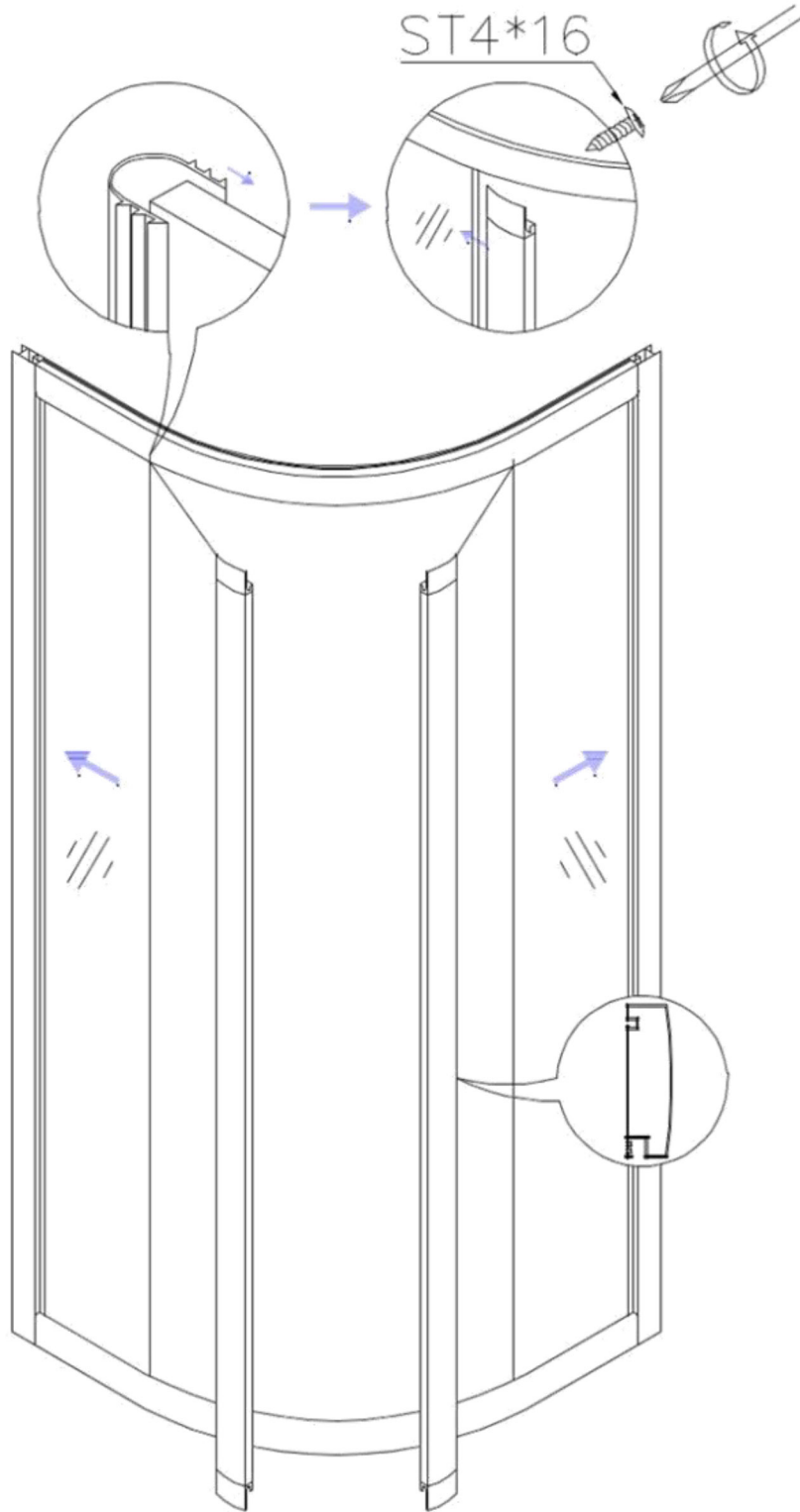
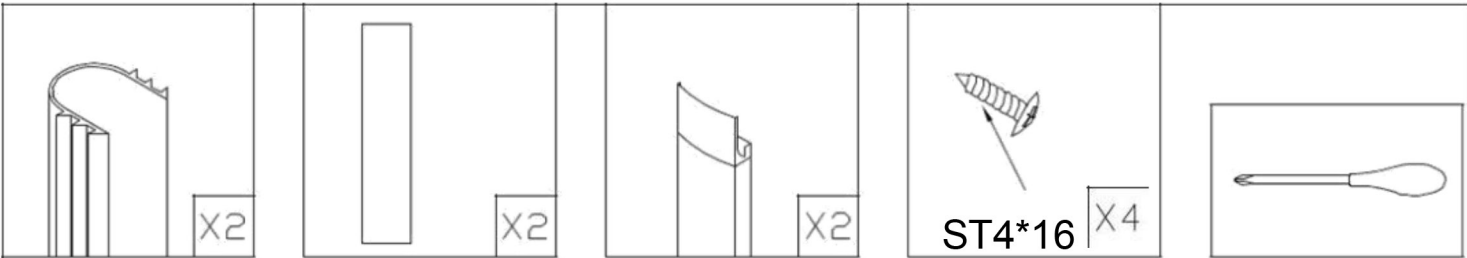

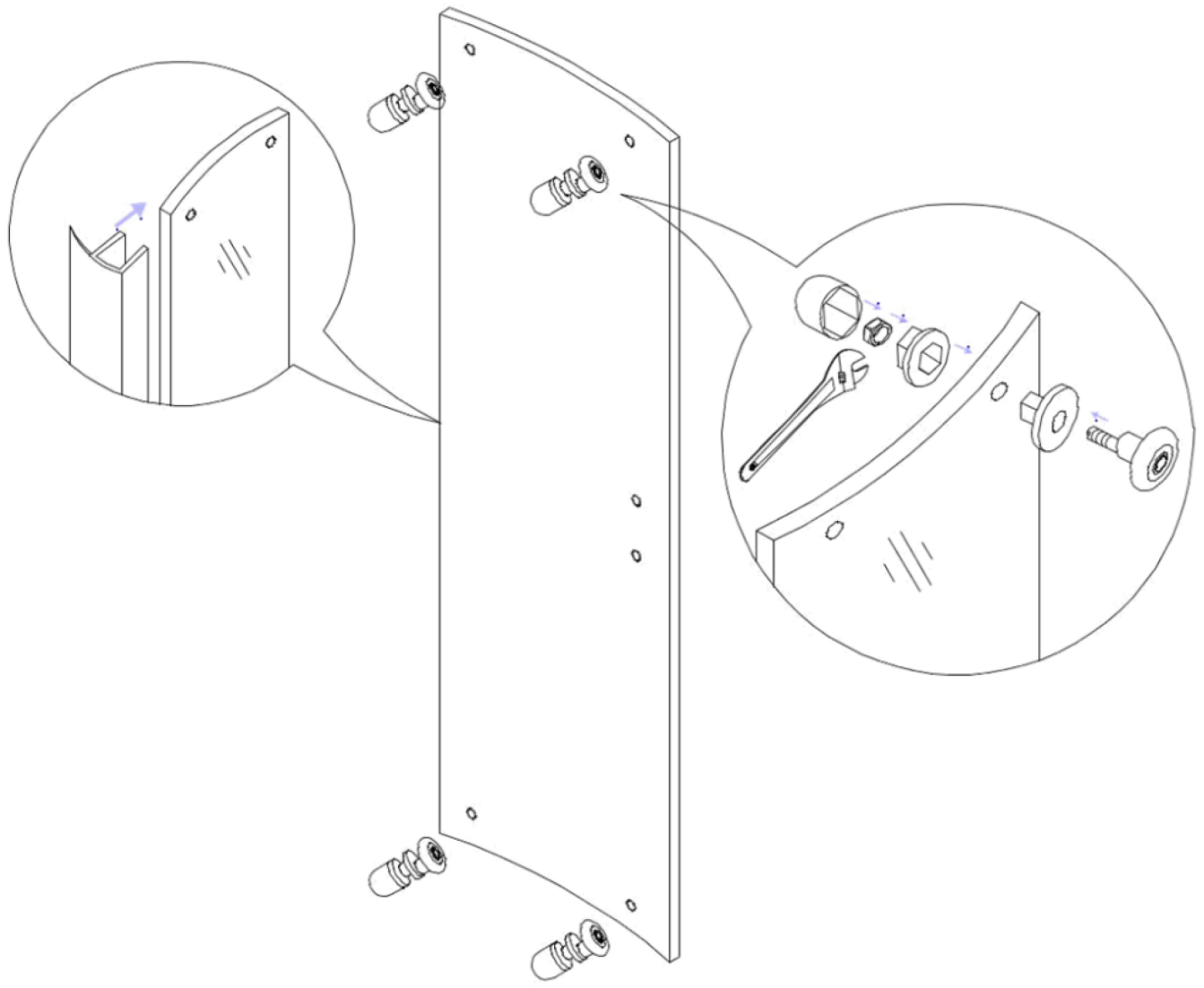
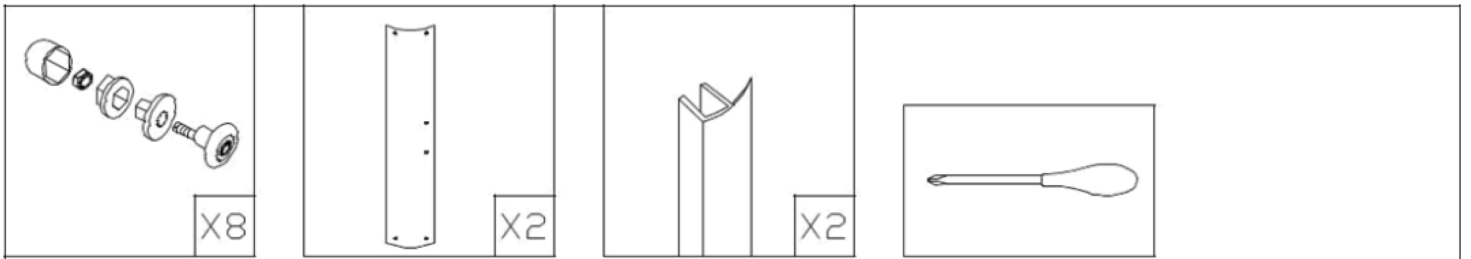

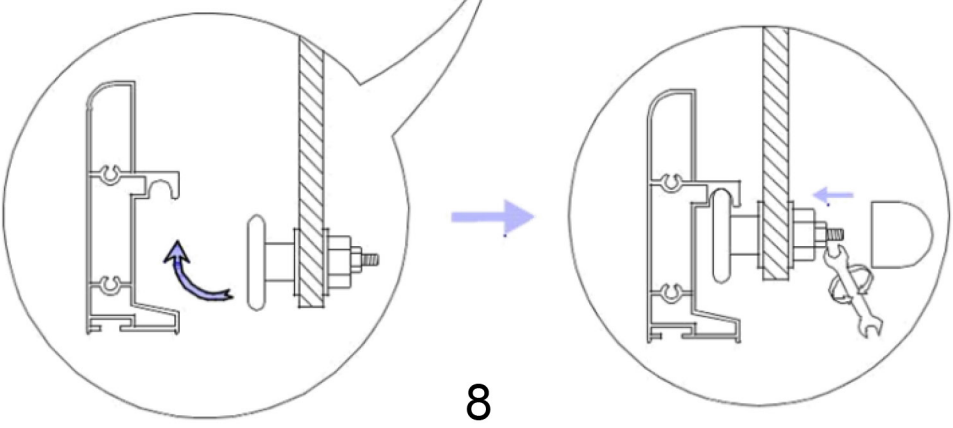
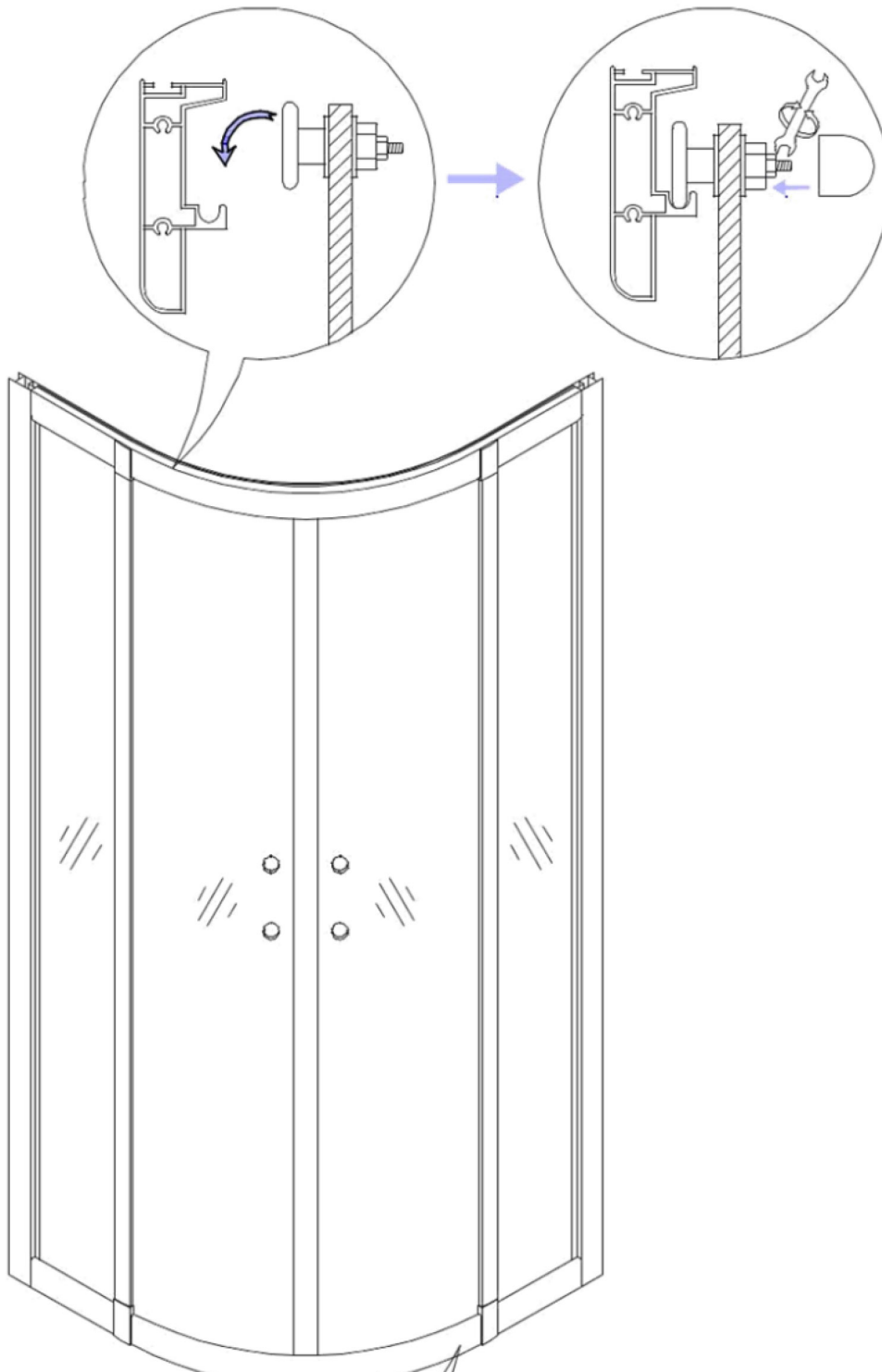

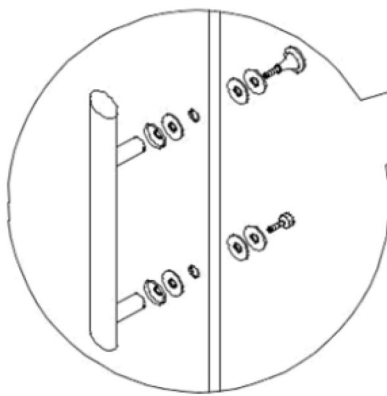
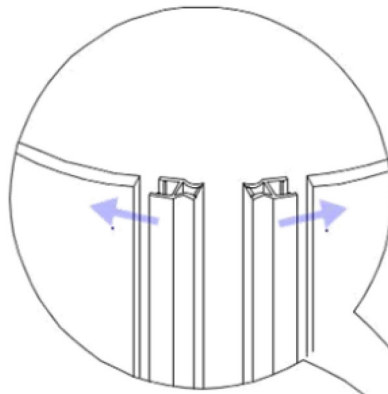
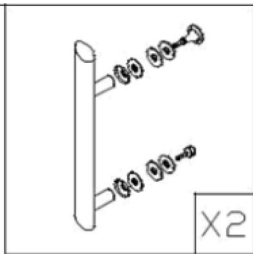
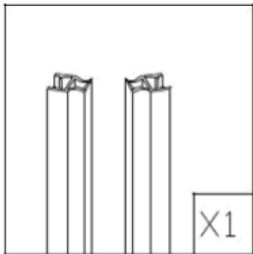

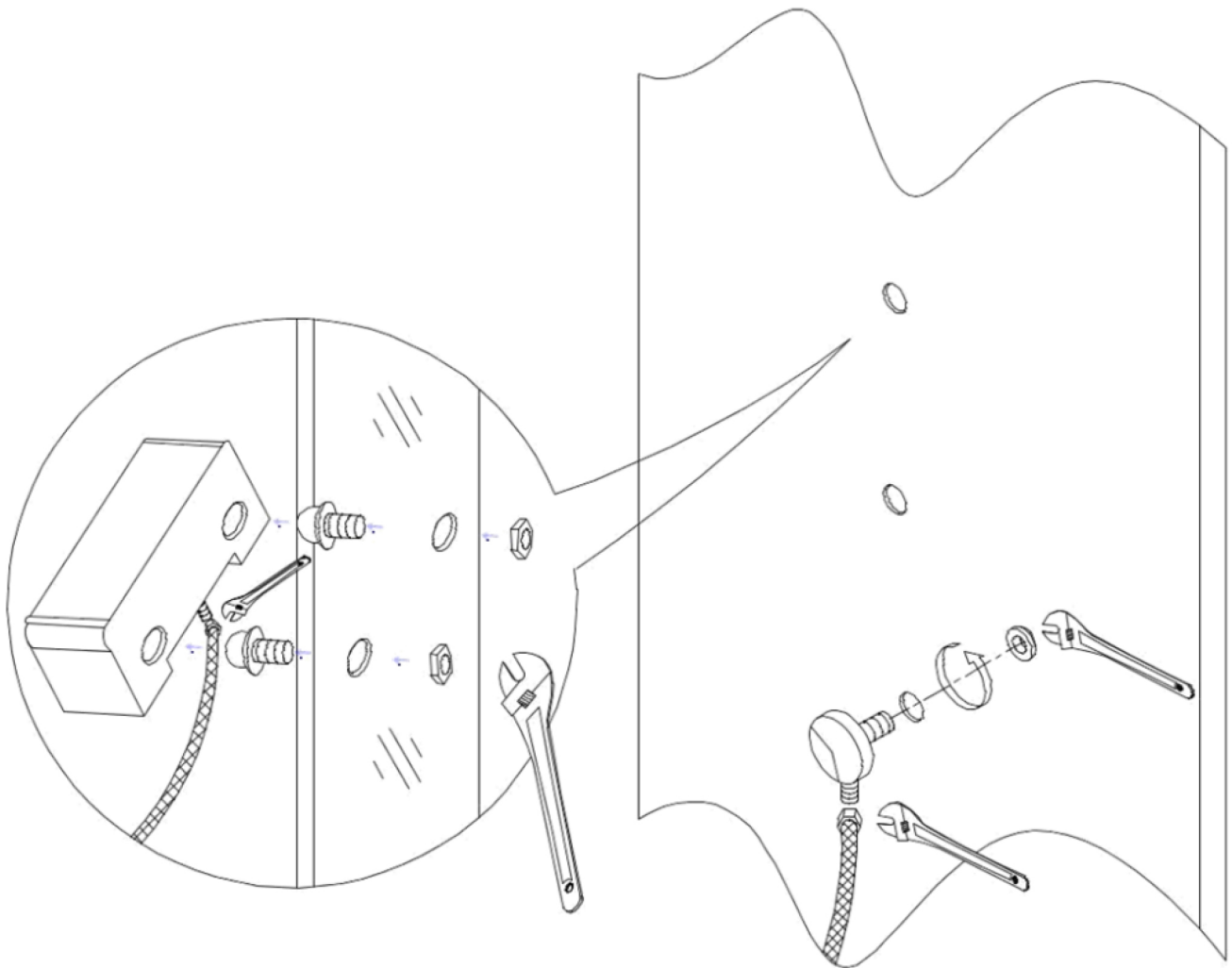
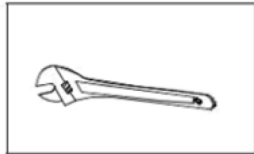
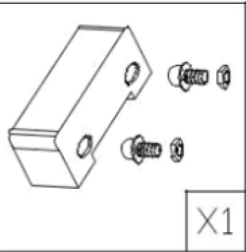



X1

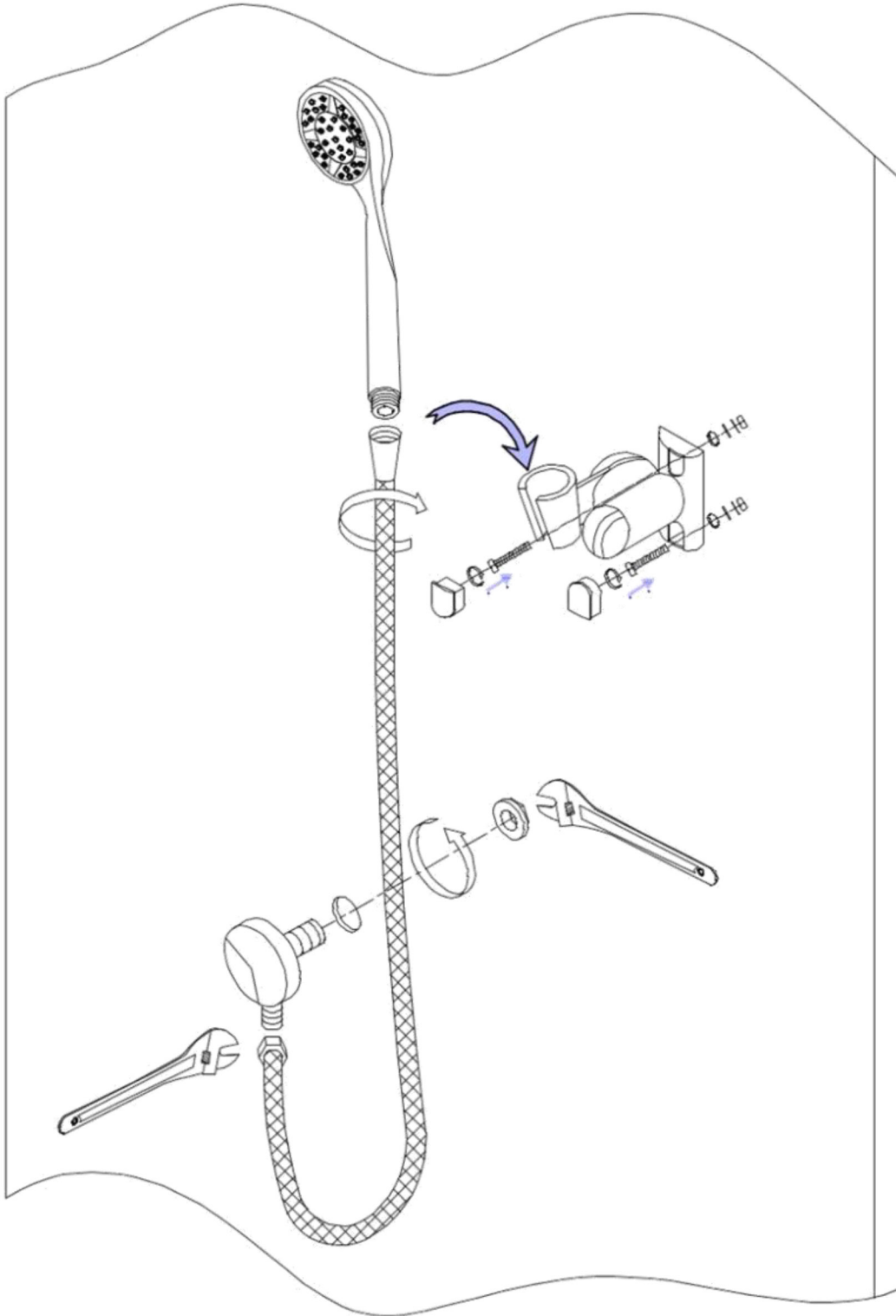

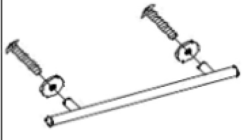

X1

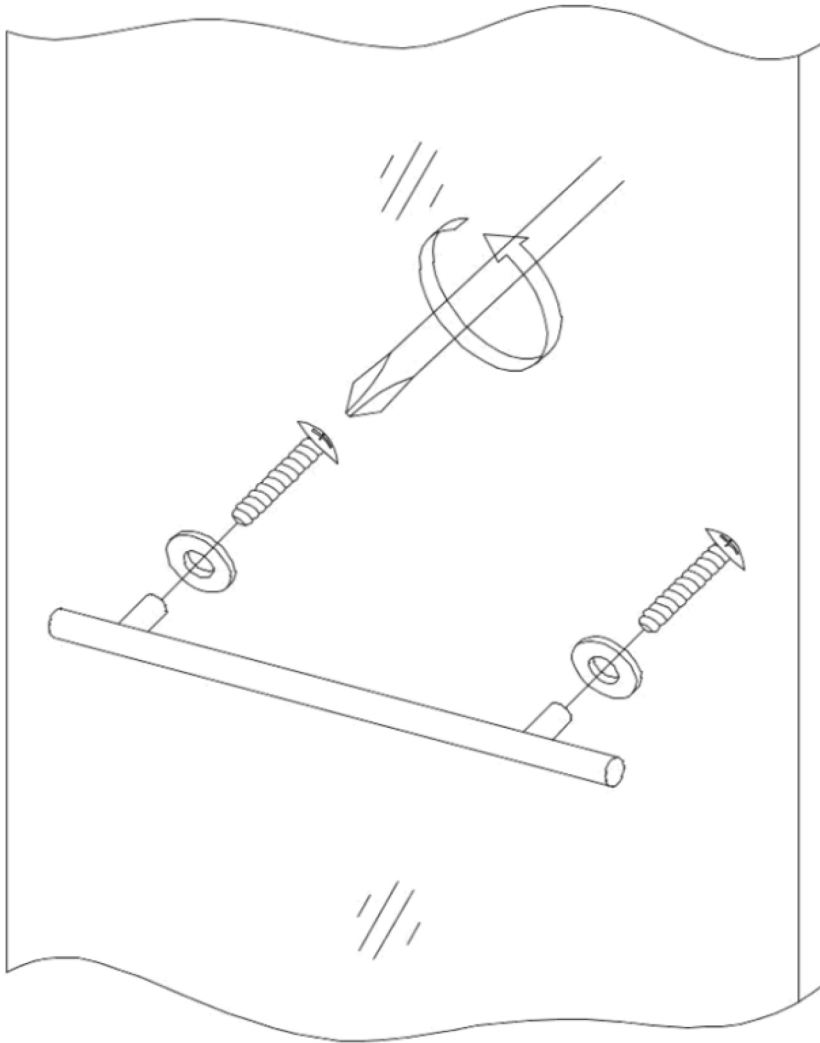
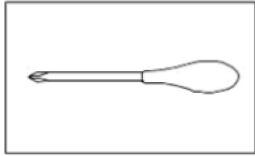

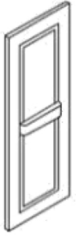

X1

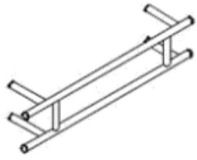

X1

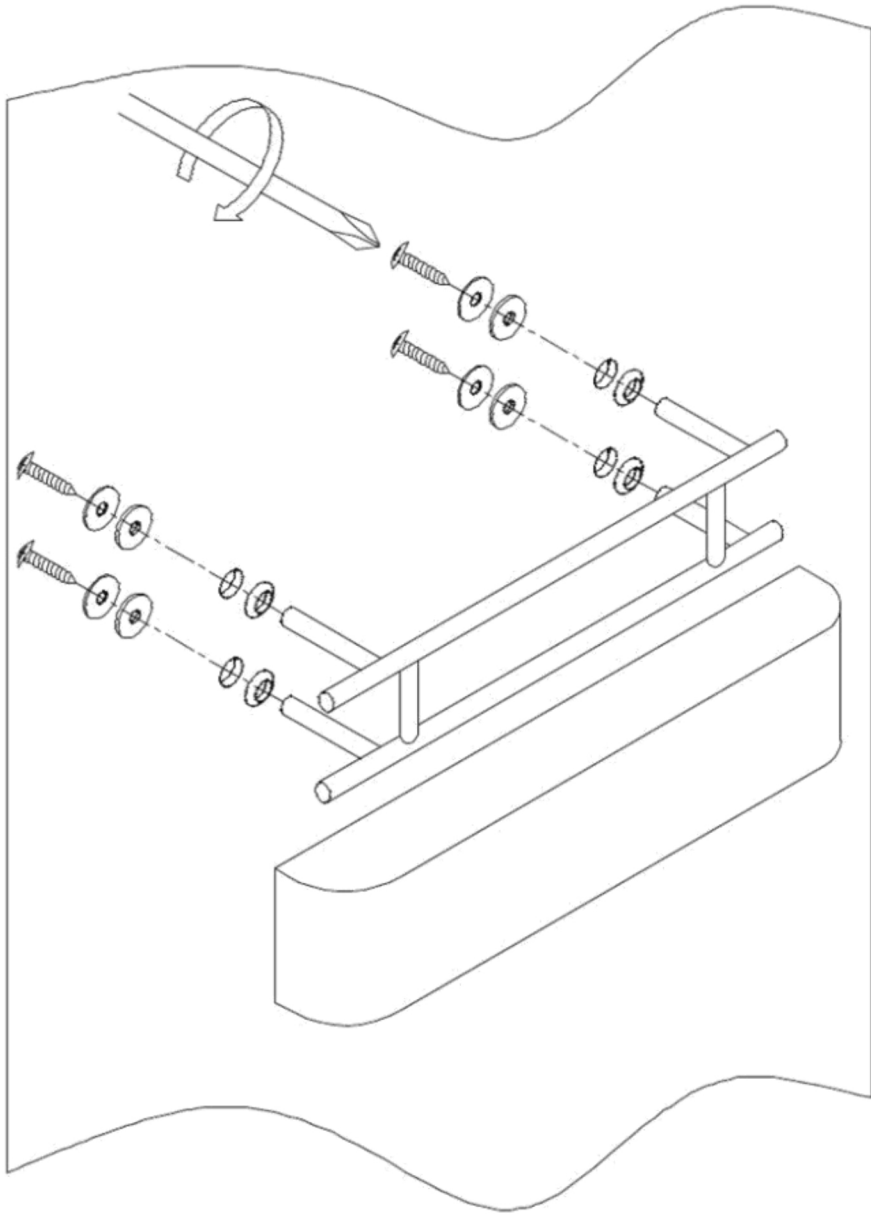
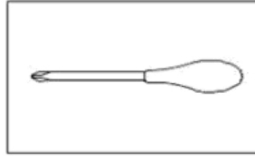



ST4*16 X10

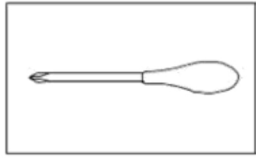

10-ST4*16

