

Box Doccia Idromassaggio

In questo manuale è illustrata la procedura di montaggio dei Box Doccia Idromassaggio. Prima di montarla, consigliamo di consultare il presente manuale di istruzioni per realizzare il montaggio correttamente.

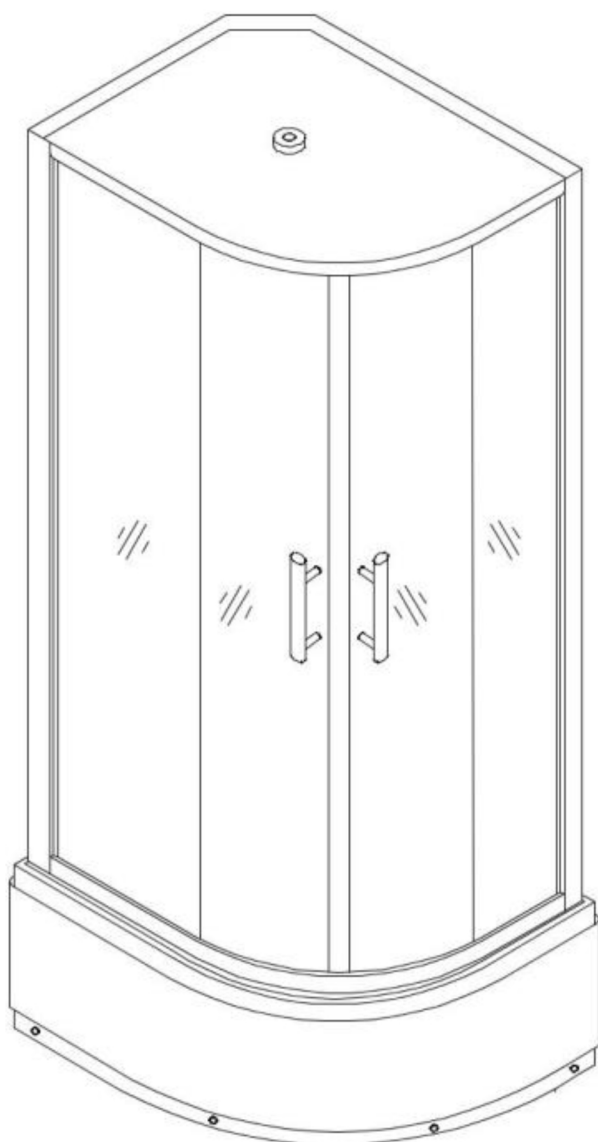

1/4

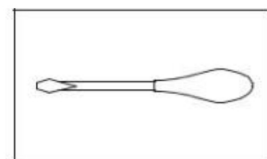
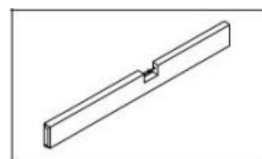
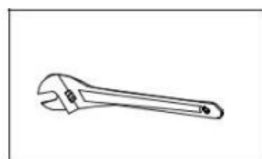
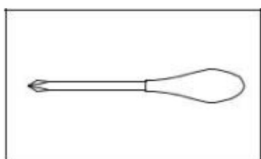
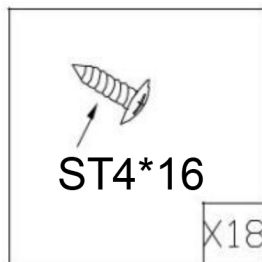
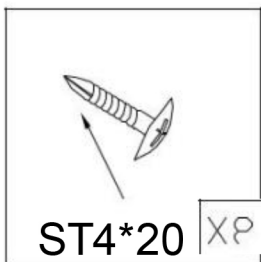
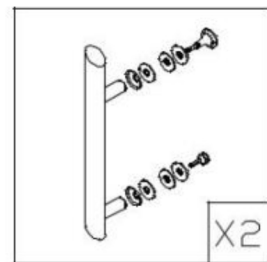
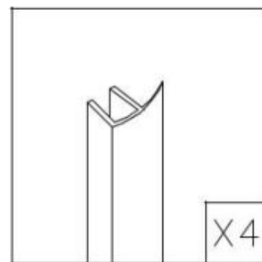
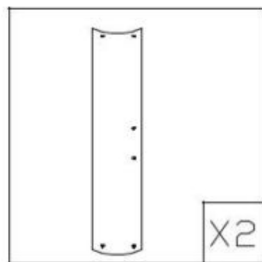
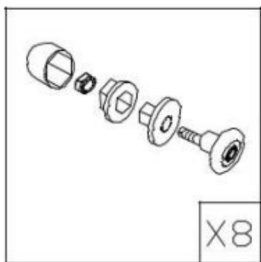
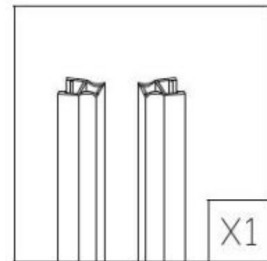
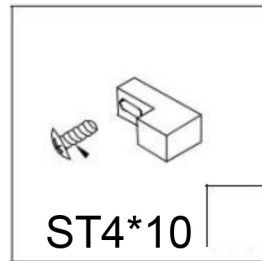
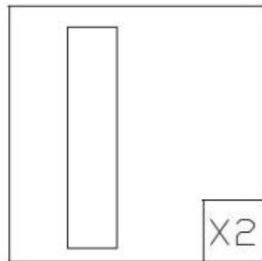
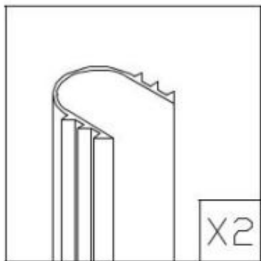
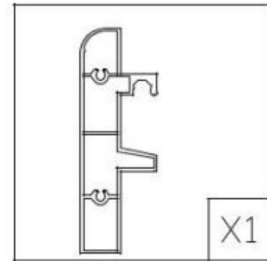
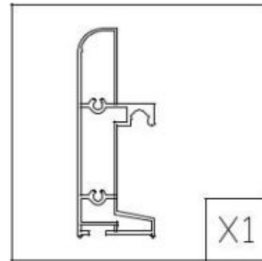
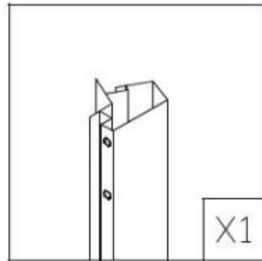
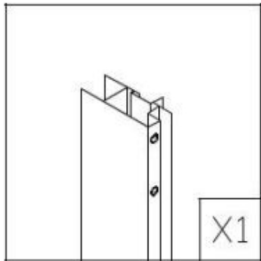
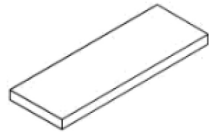

2/4

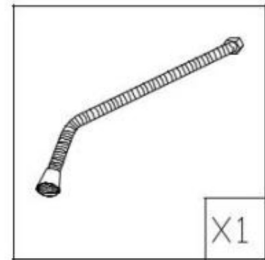
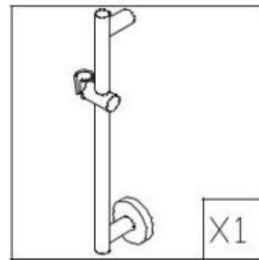
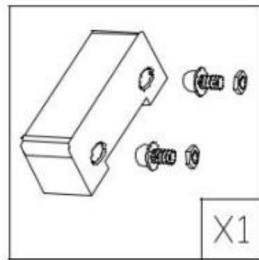
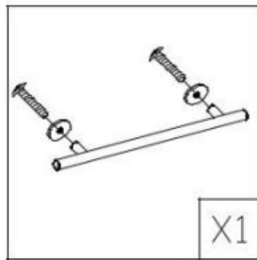
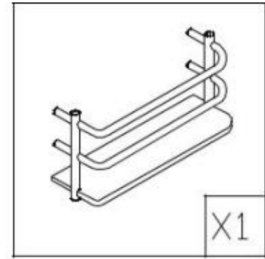
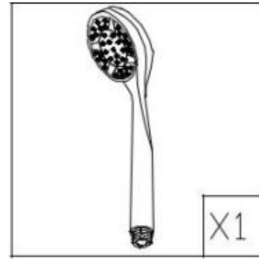
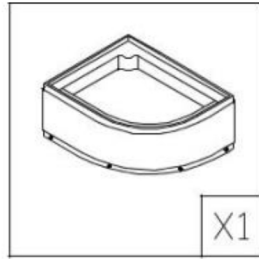
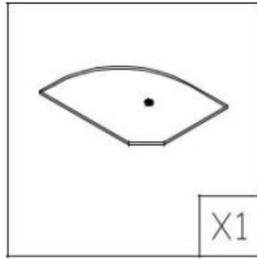
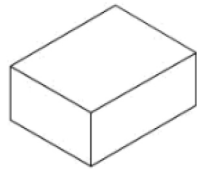

3/4

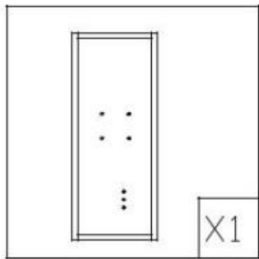
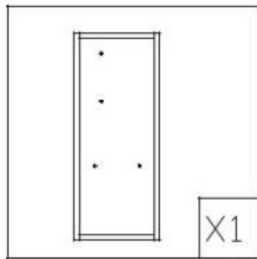
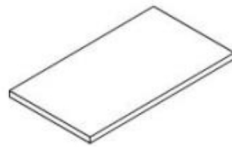

4/4

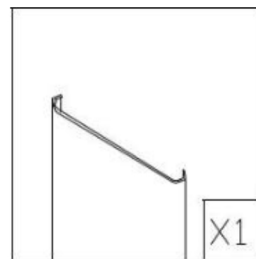
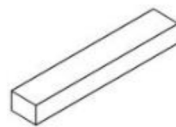

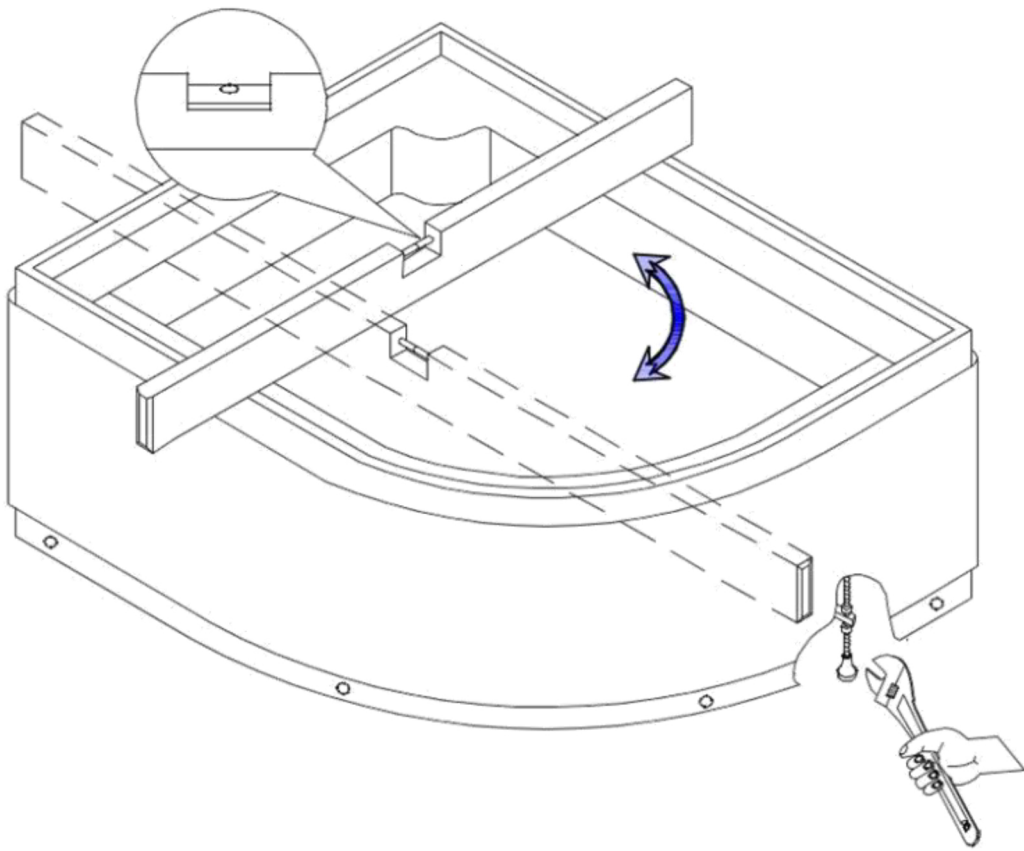
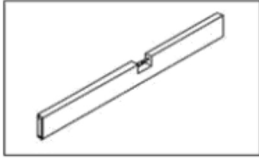
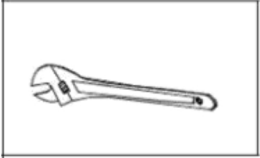

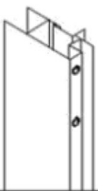

X1

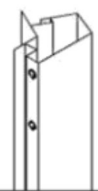

X1

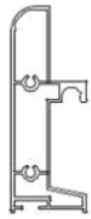

X1



X1



ST4*16

X8

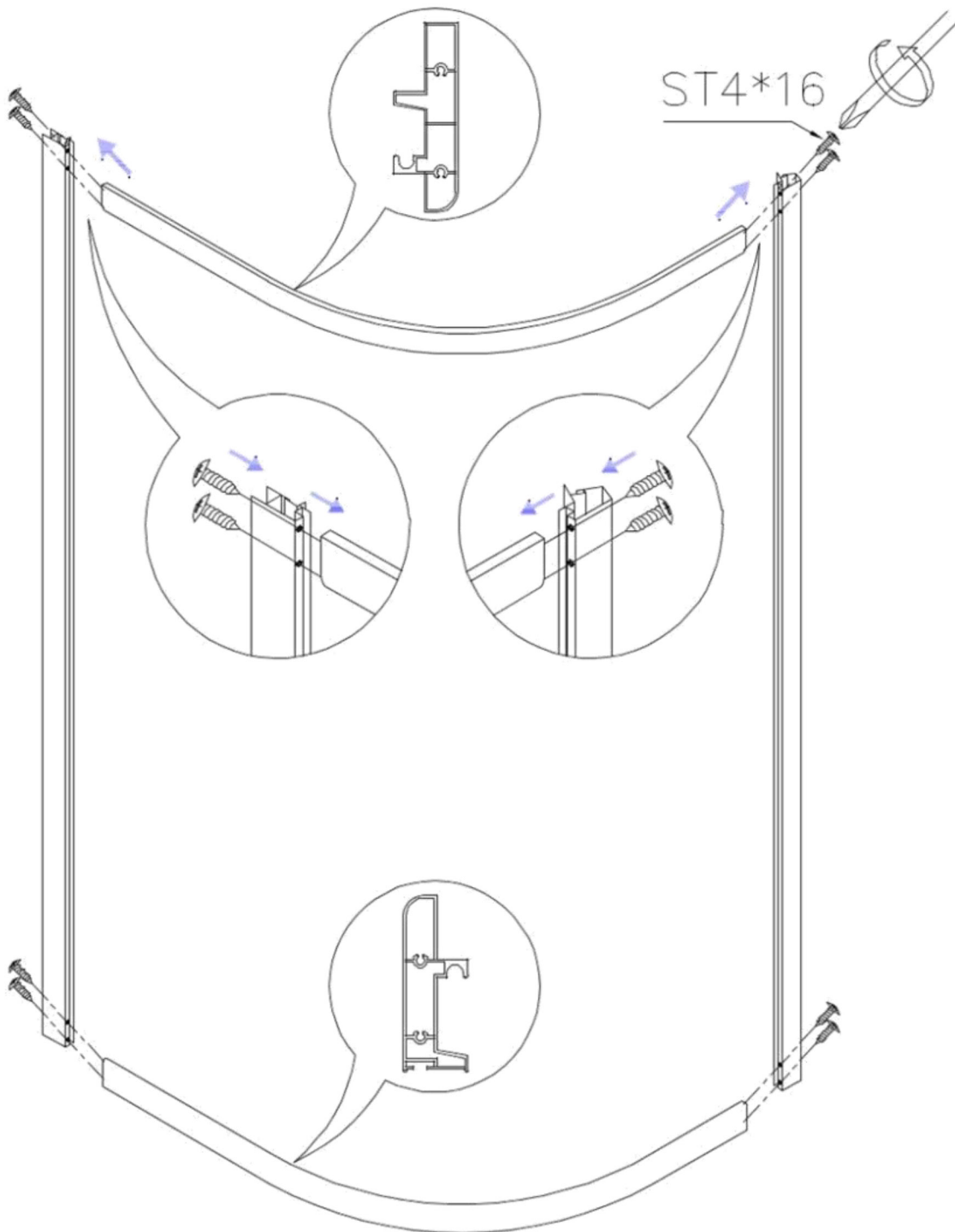

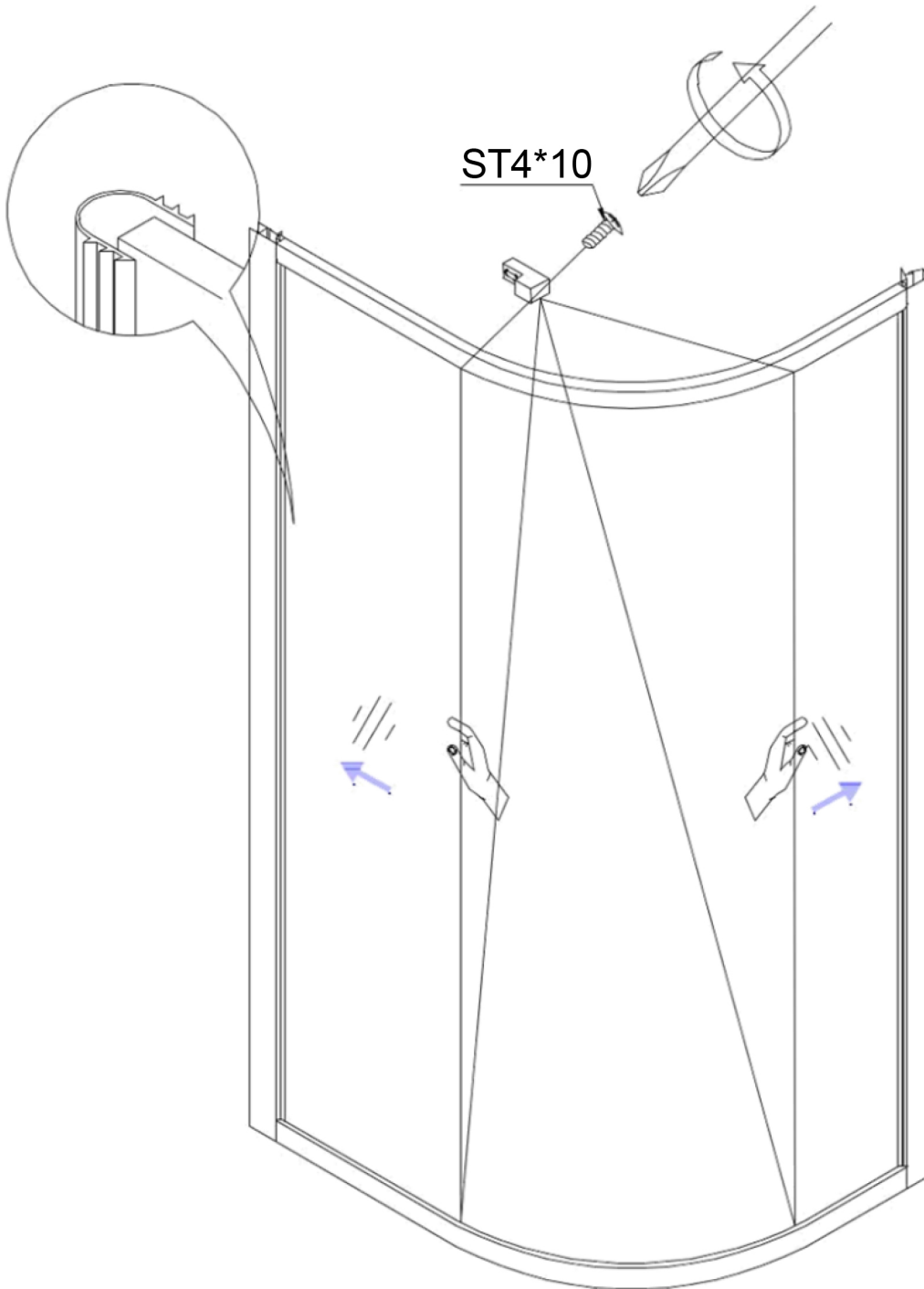
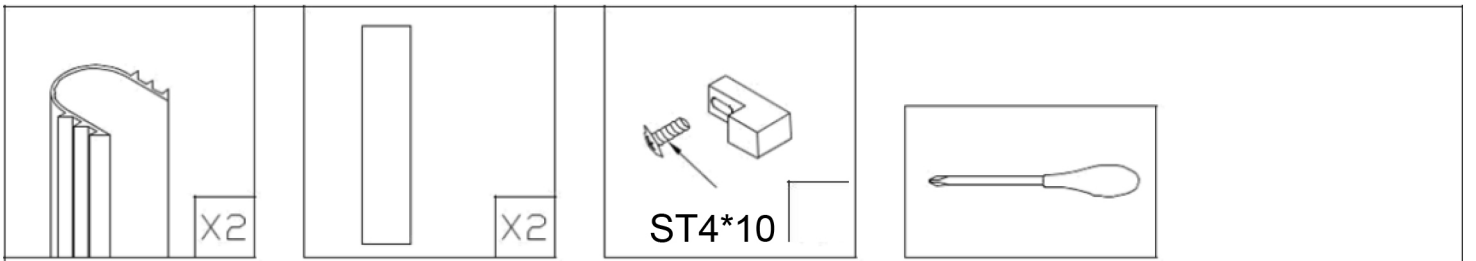

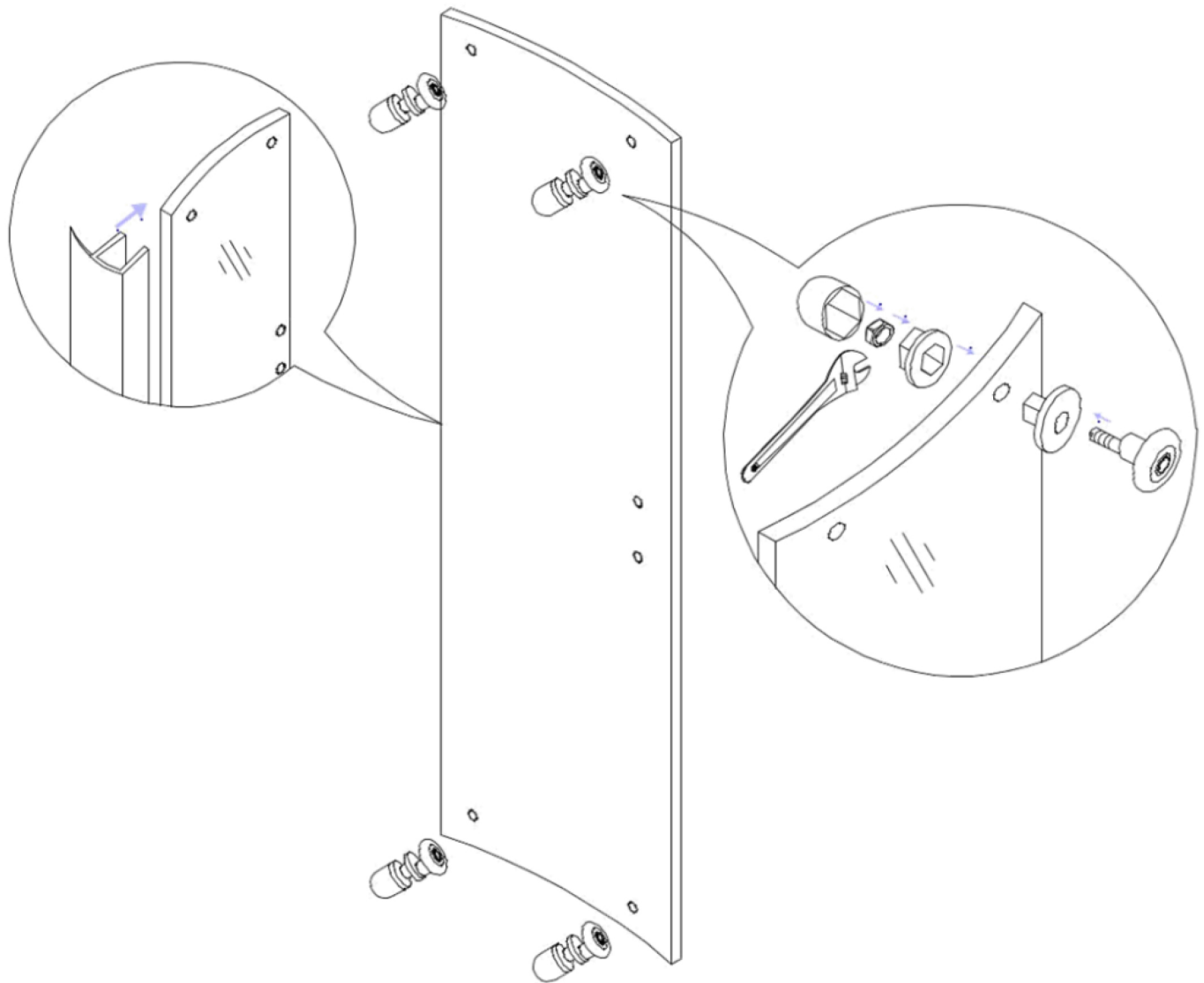
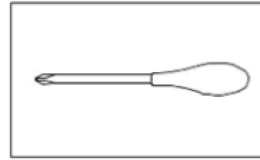
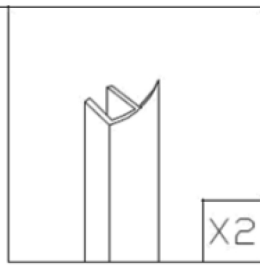
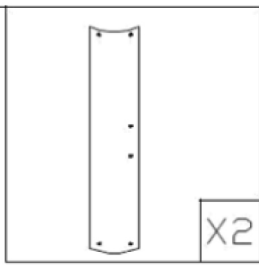
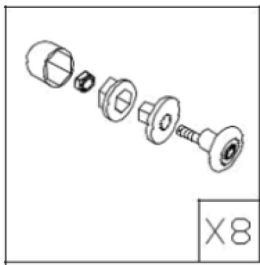

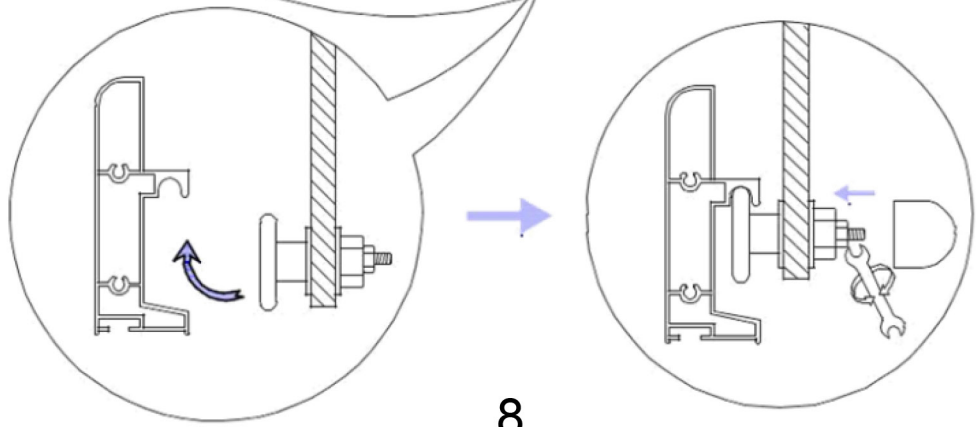
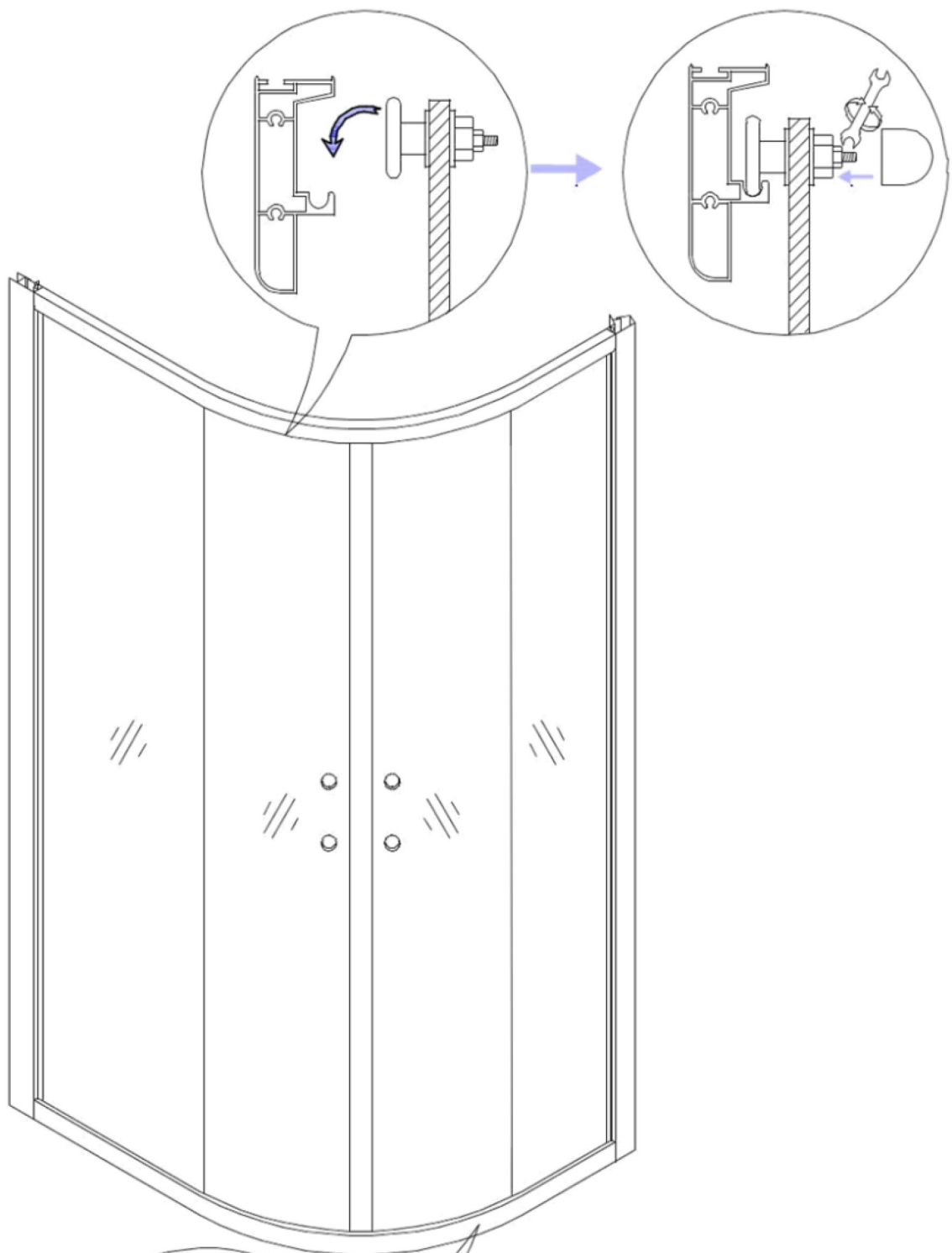

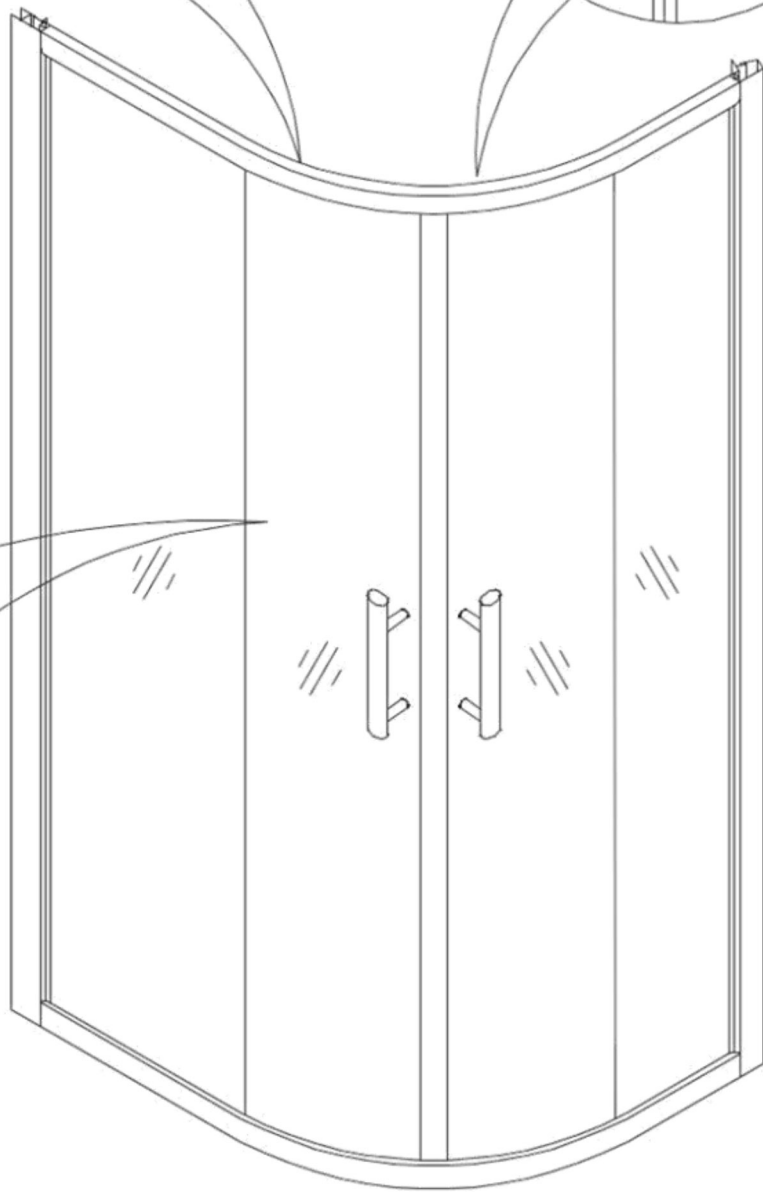
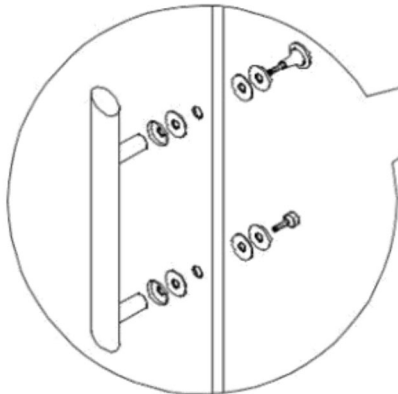
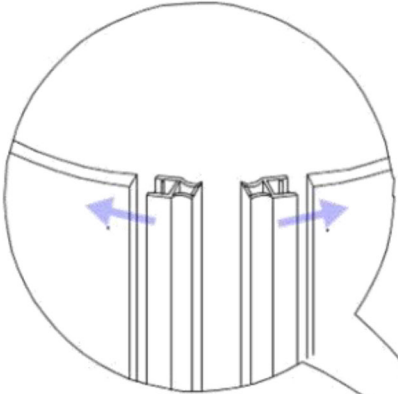
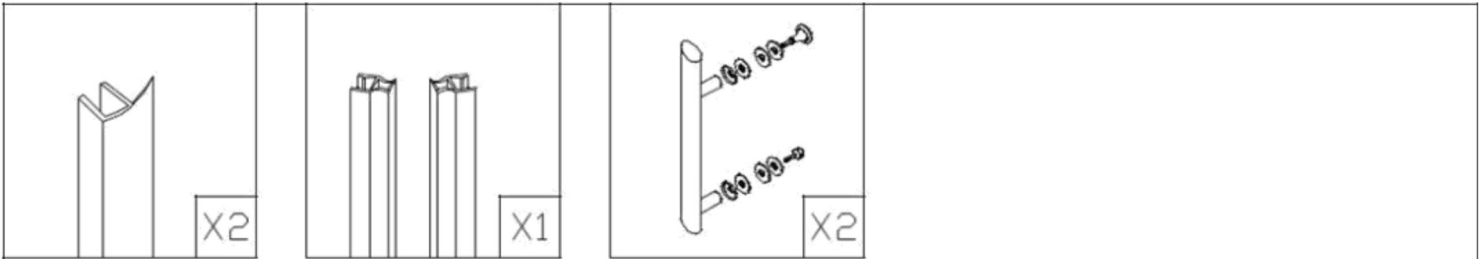

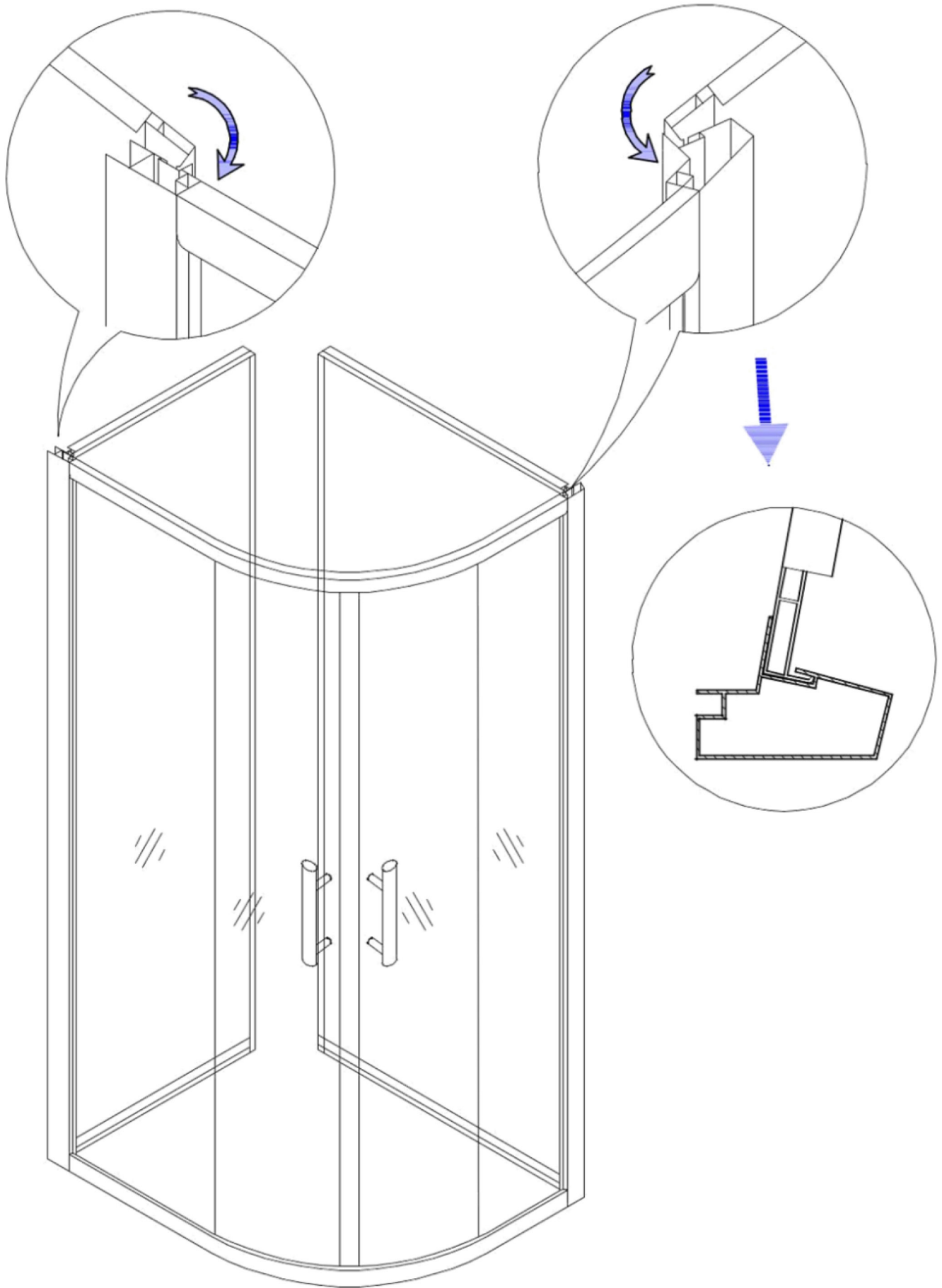



ST4*16

X10



ST4*20

X8

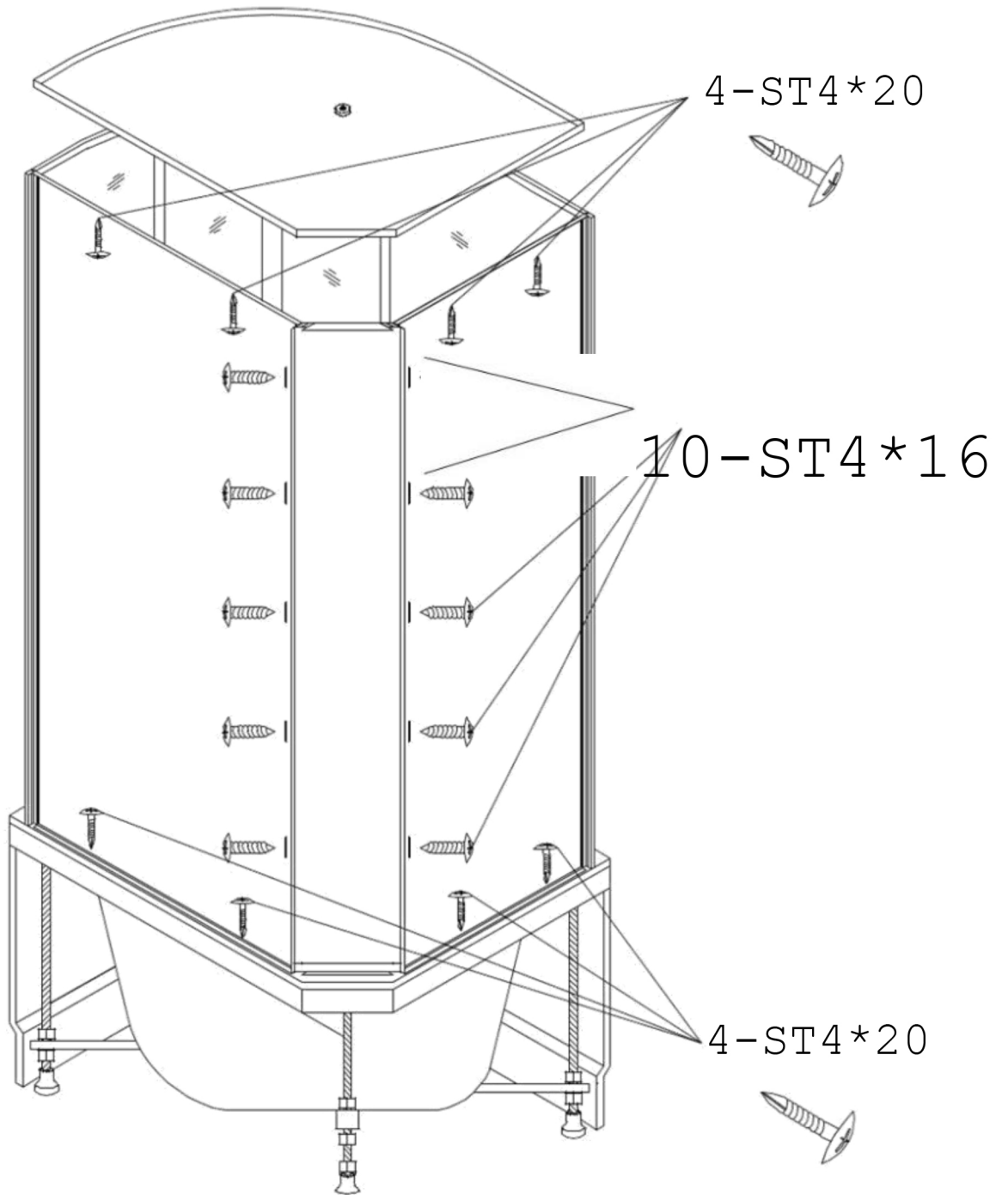
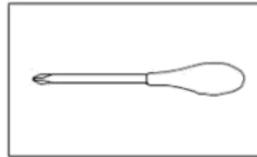

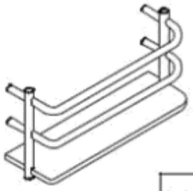

X1

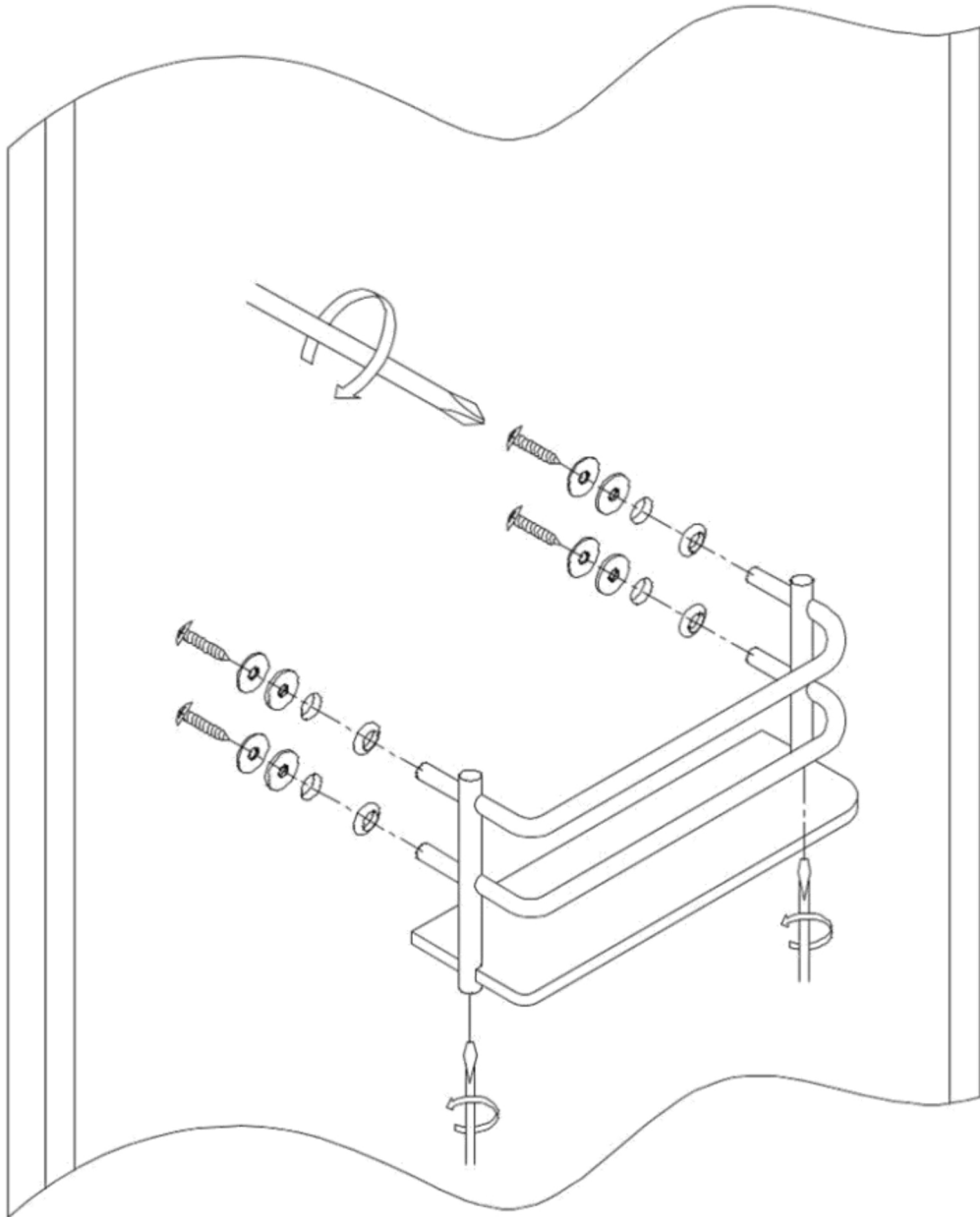
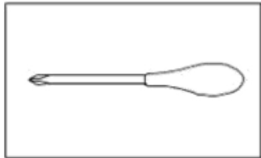



X1

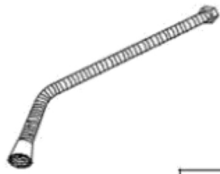

X1



X1

