

DOCCIA IDROMASSAGGIO

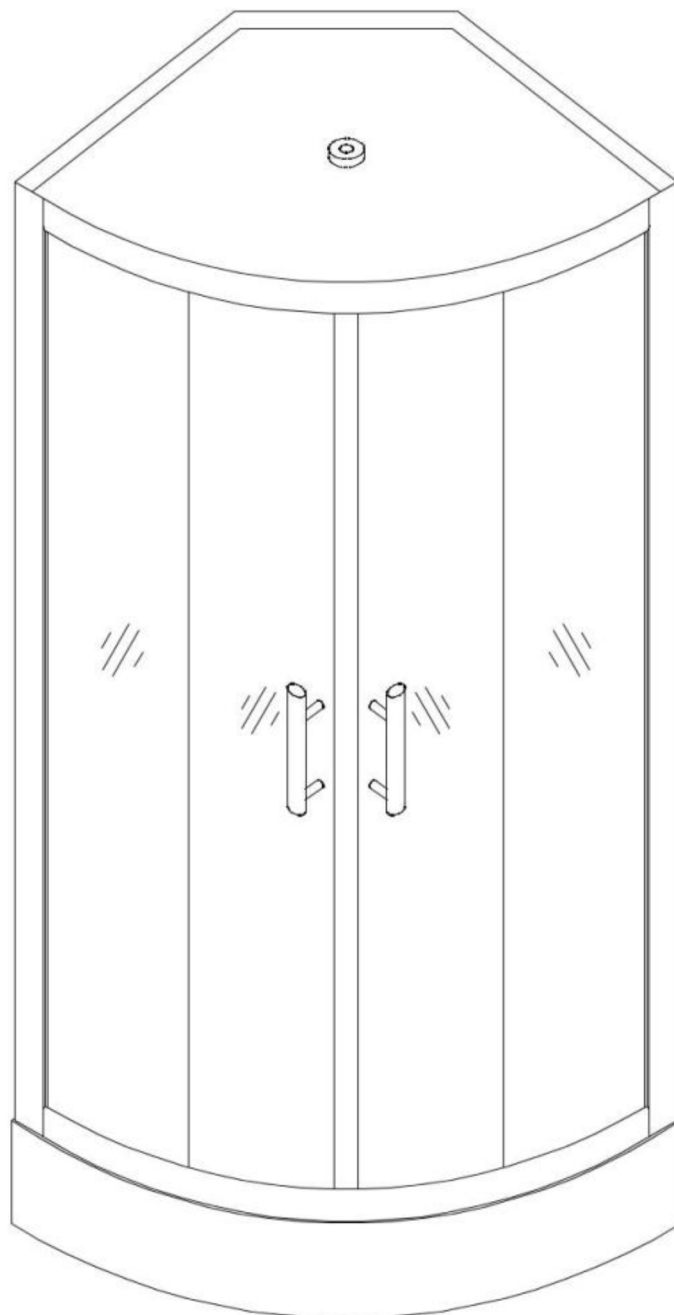

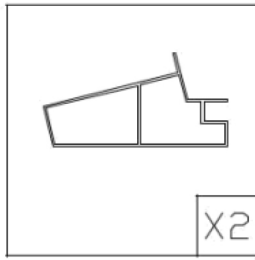

X2

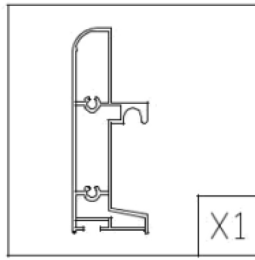

X1

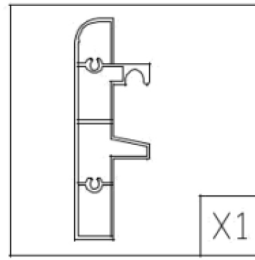

X1

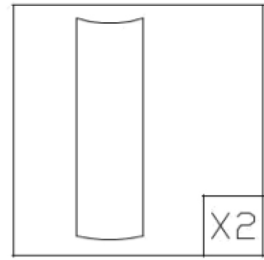

X2

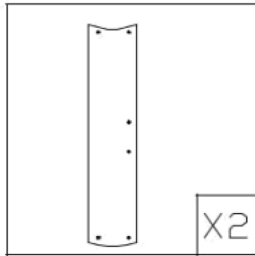

X2

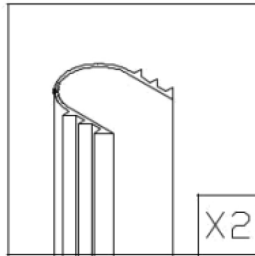

X2

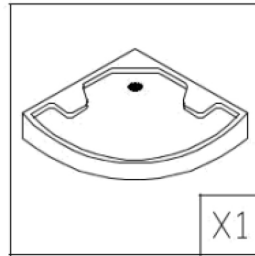

X1

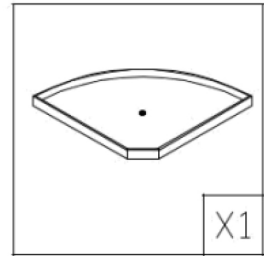

X1

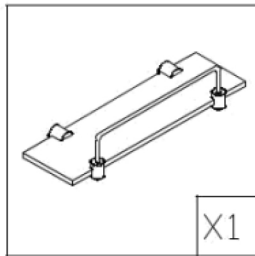

X1

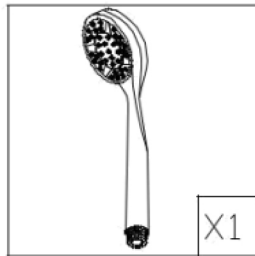

X1

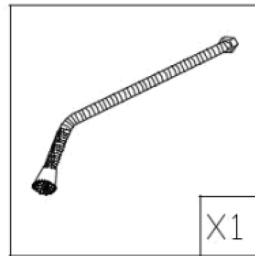

X1

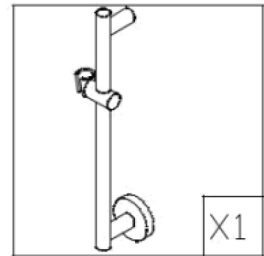

X1

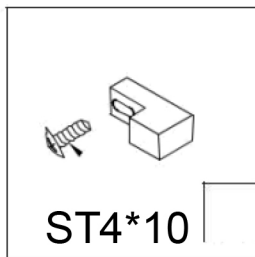

ST4*10

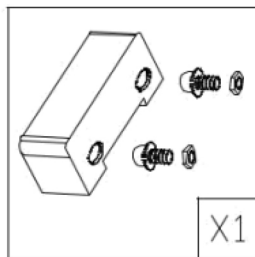

X1

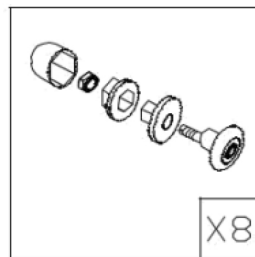

X8

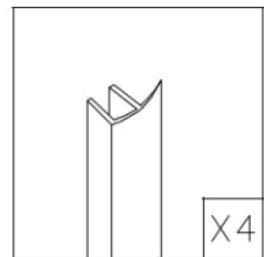

X4

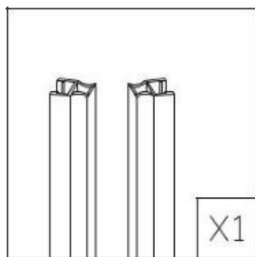

X1

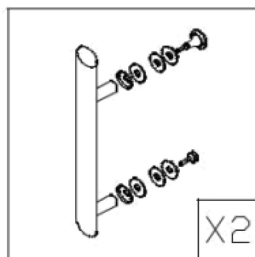

X2

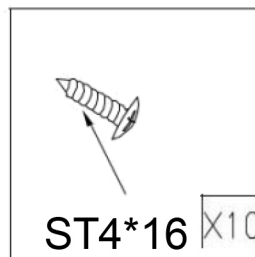

ST4*16 X10

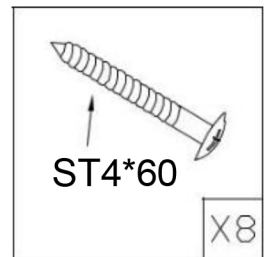

ST4*60

X8

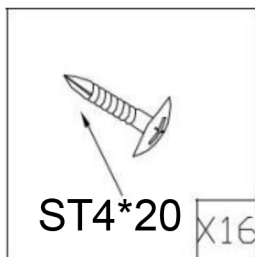

ST4*20

X16

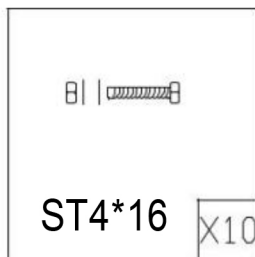

ST4*16

X10

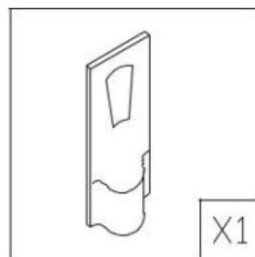

X1

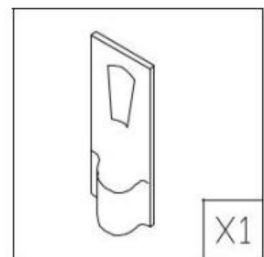

X1

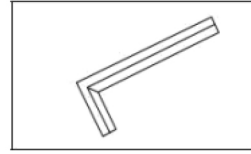
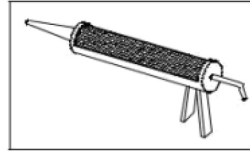
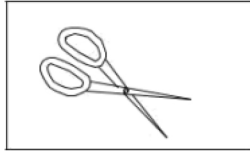
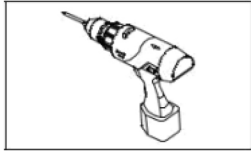
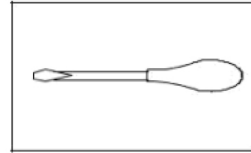
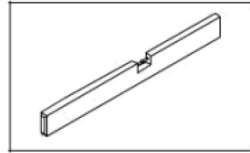
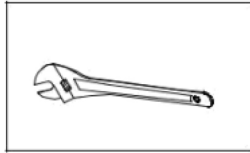
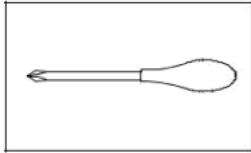

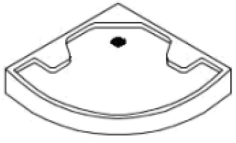

X1

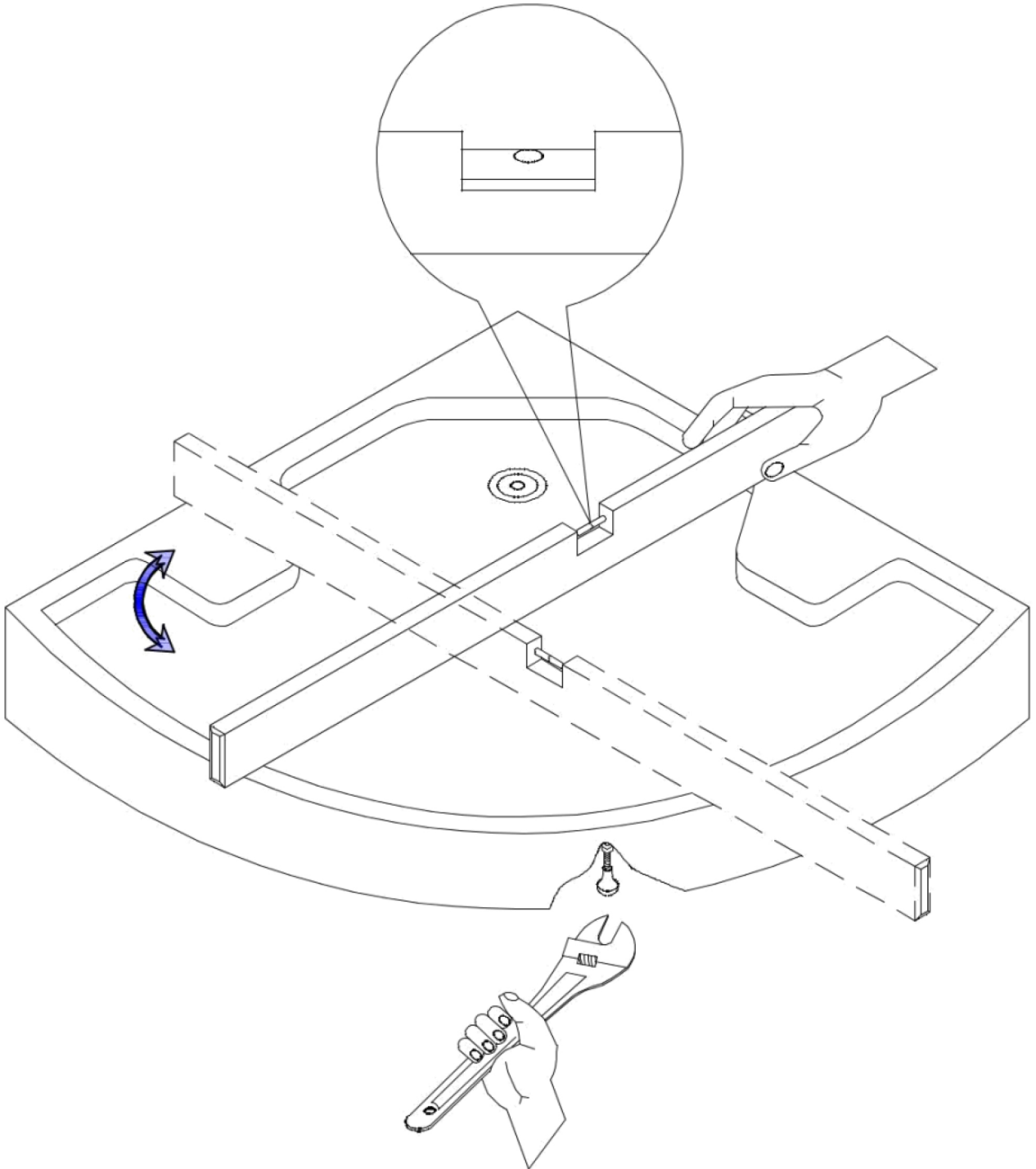
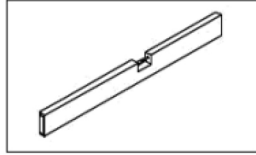
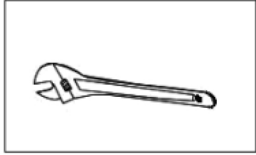

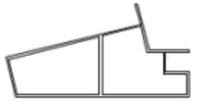

X2

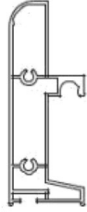

X1

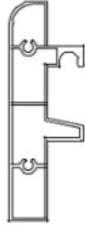

X1

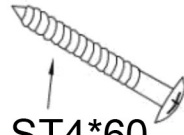

ST4*60

X8

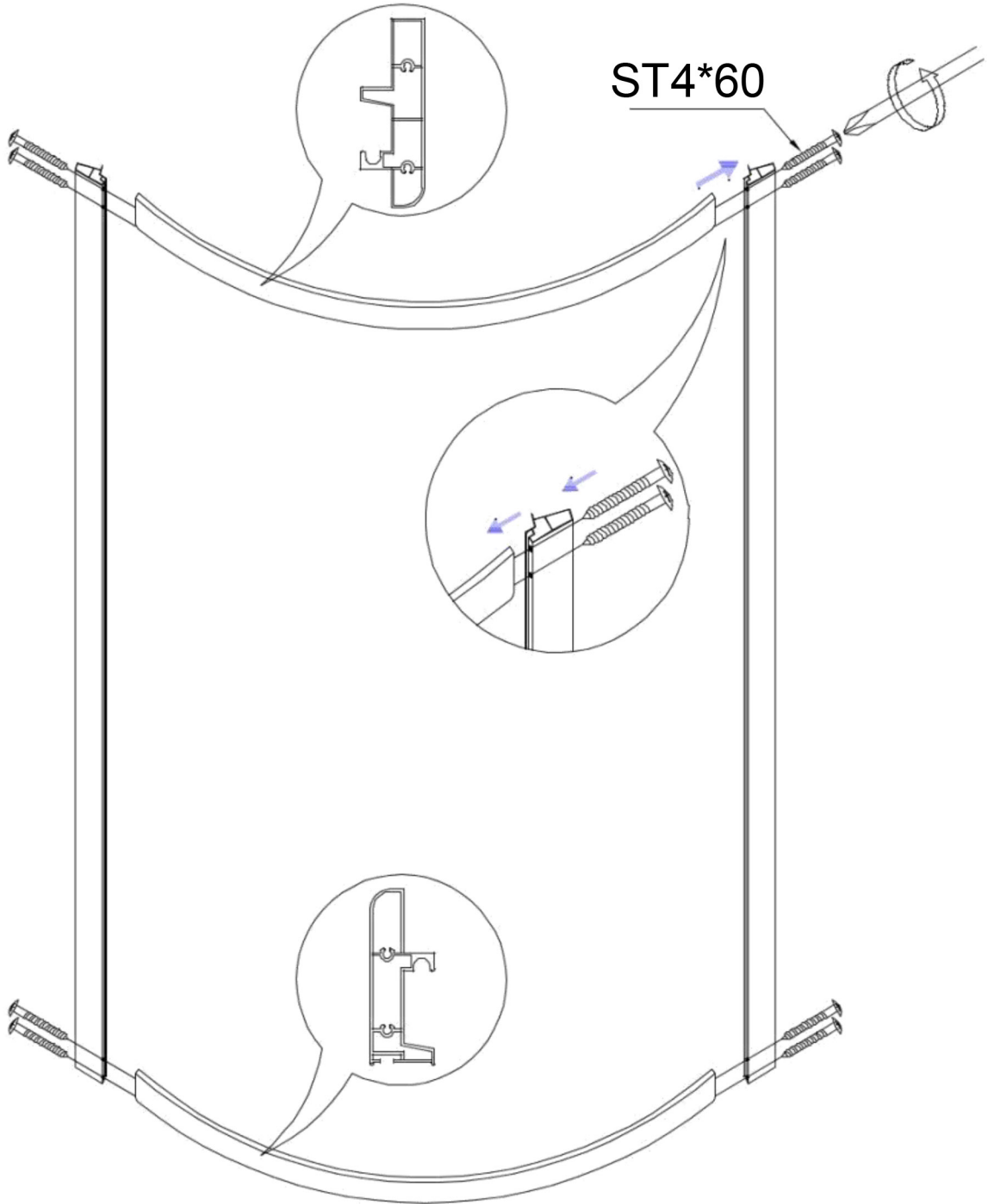

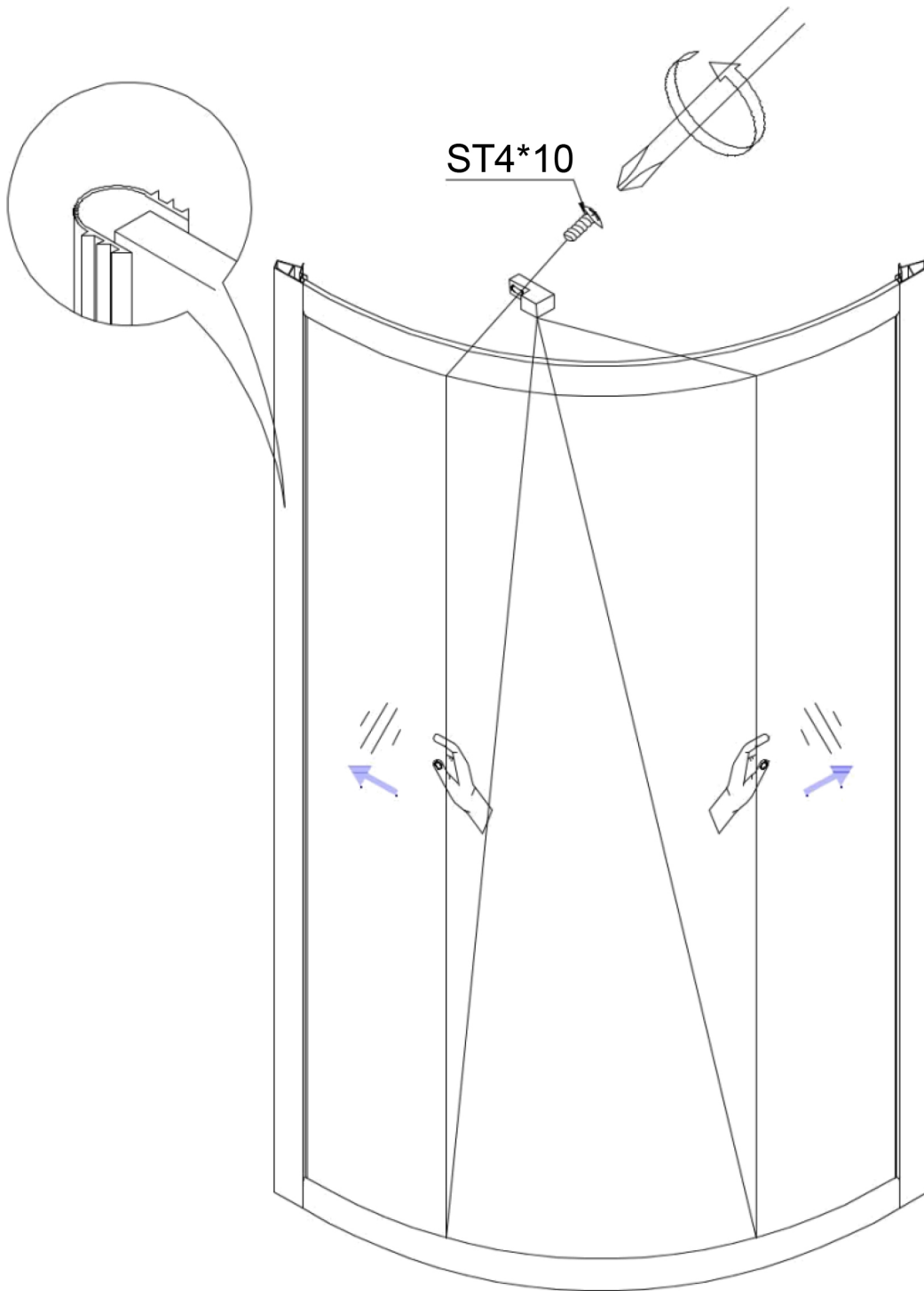
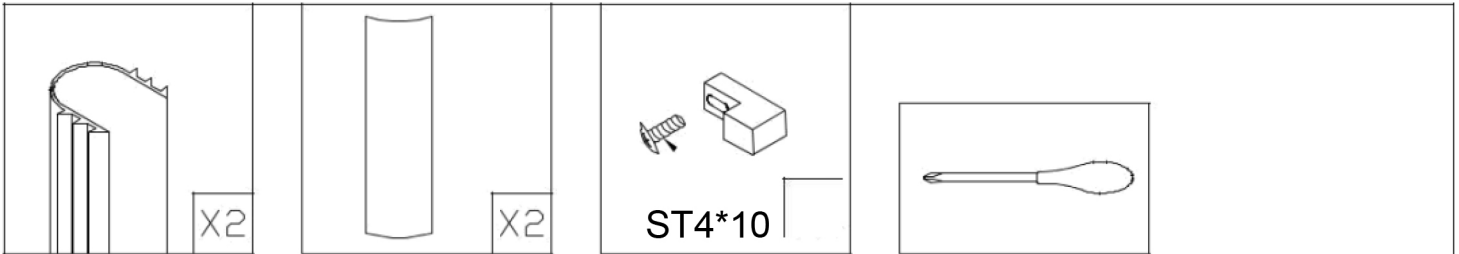

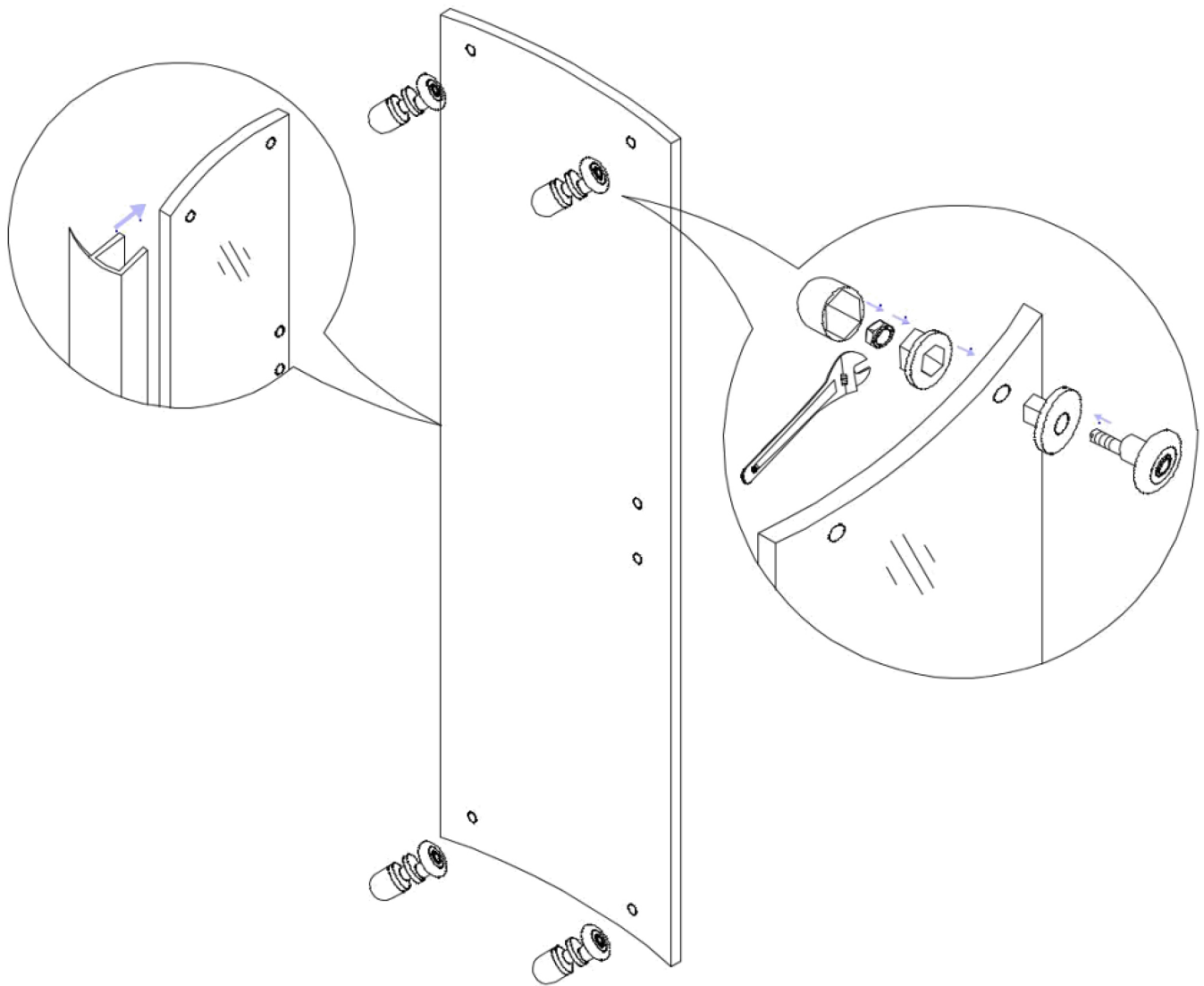
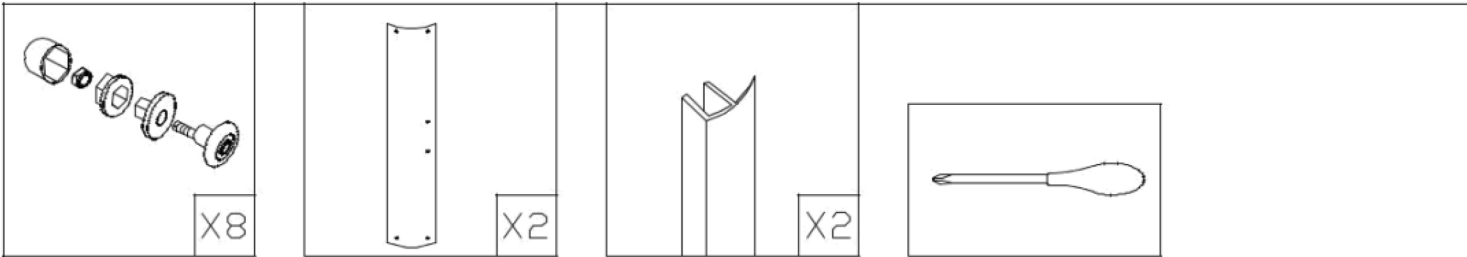

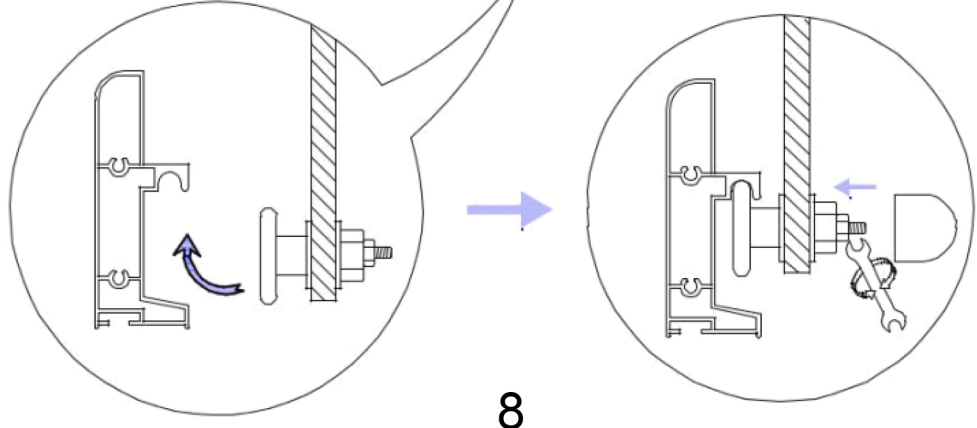
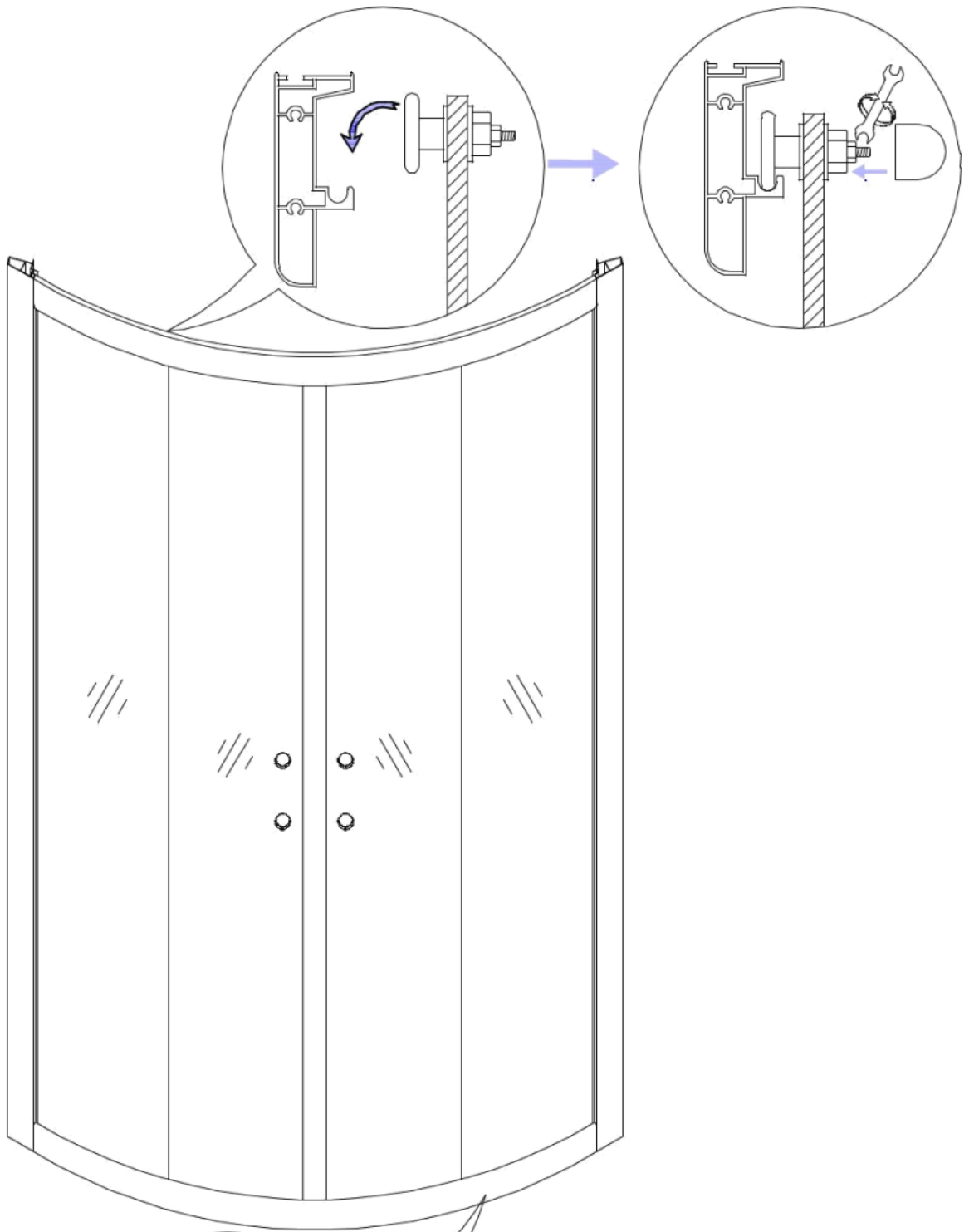

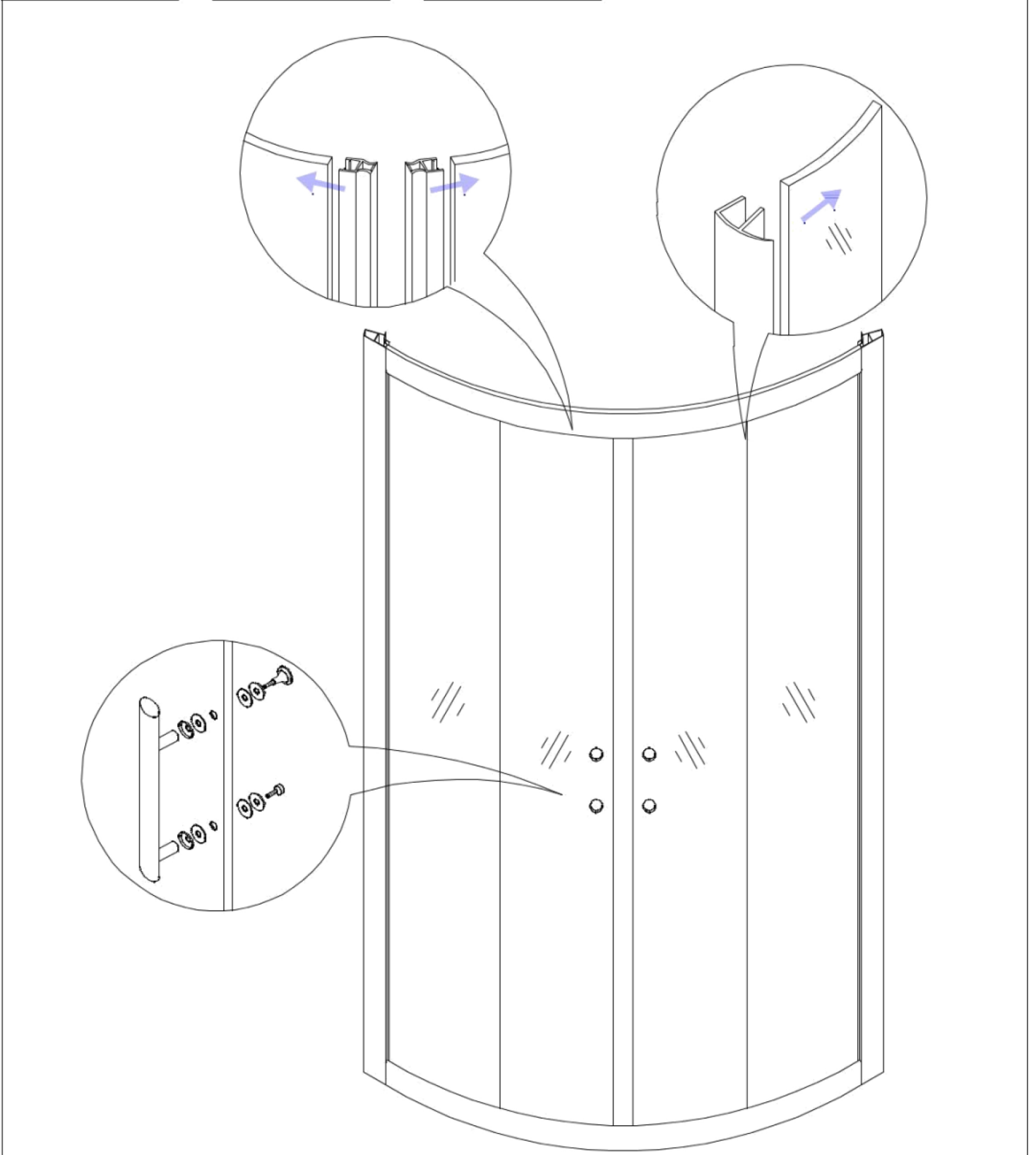
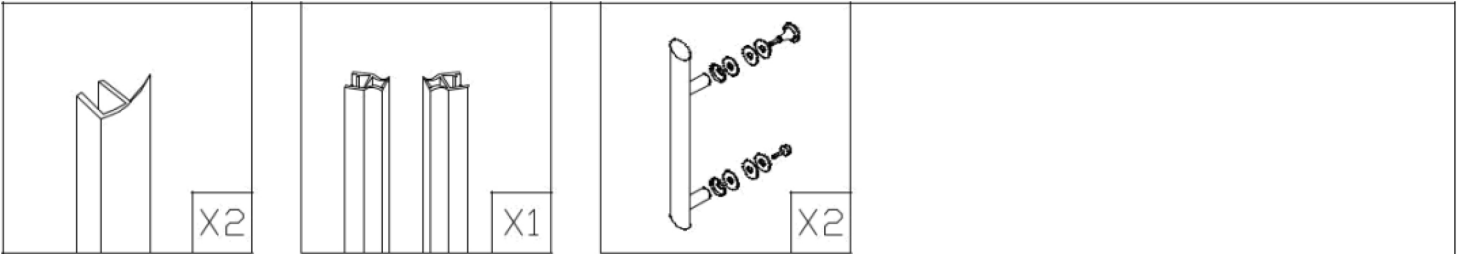



X1



X1



ST4*16 X10

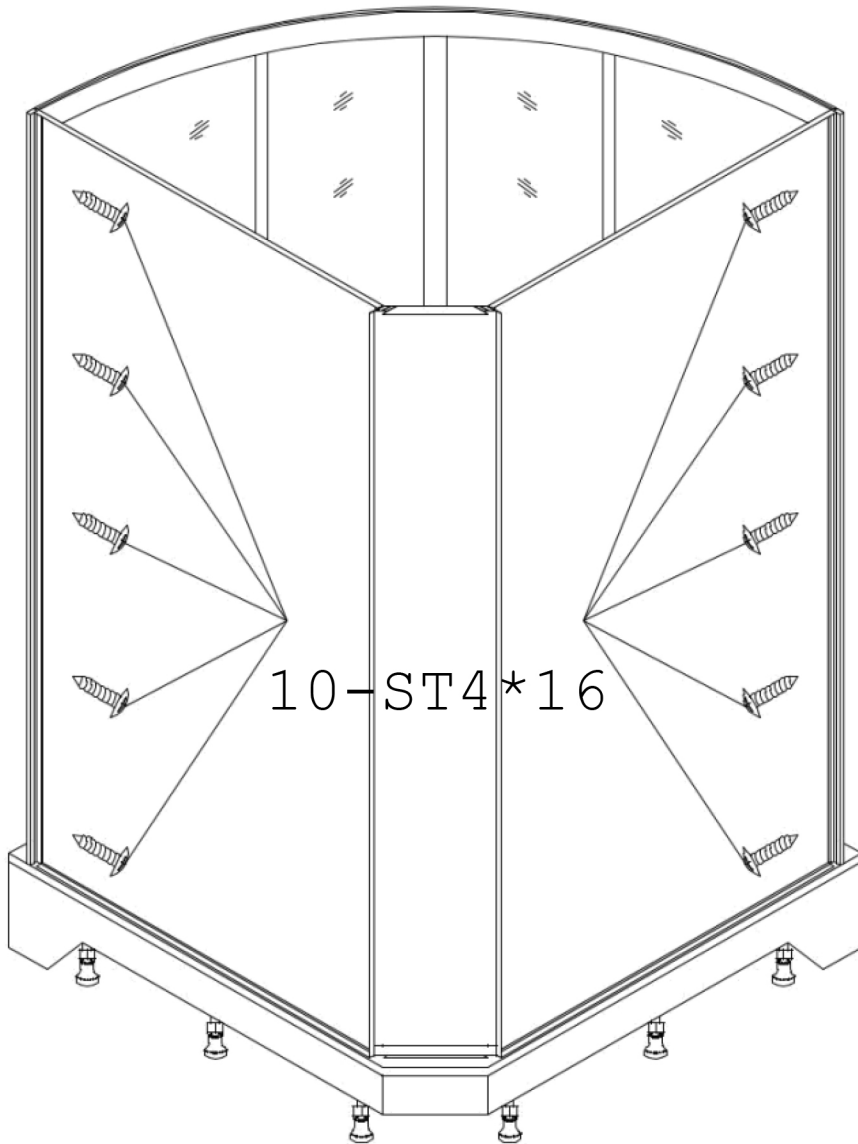
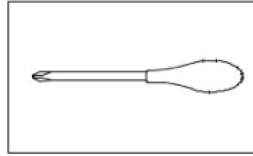

10-ST4*16



ST4*16 X10

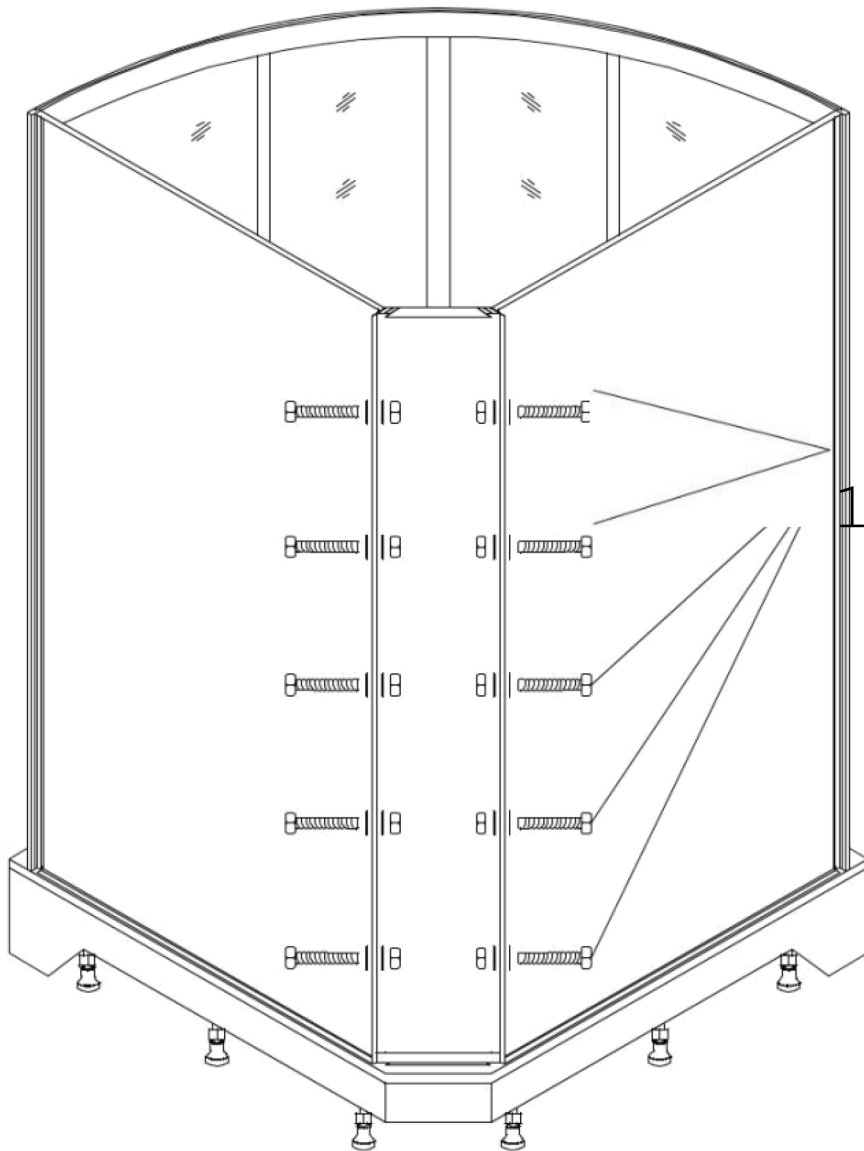
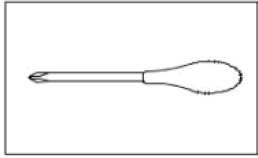

10-ST4*16

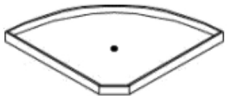

X1



ST4*20



X

16

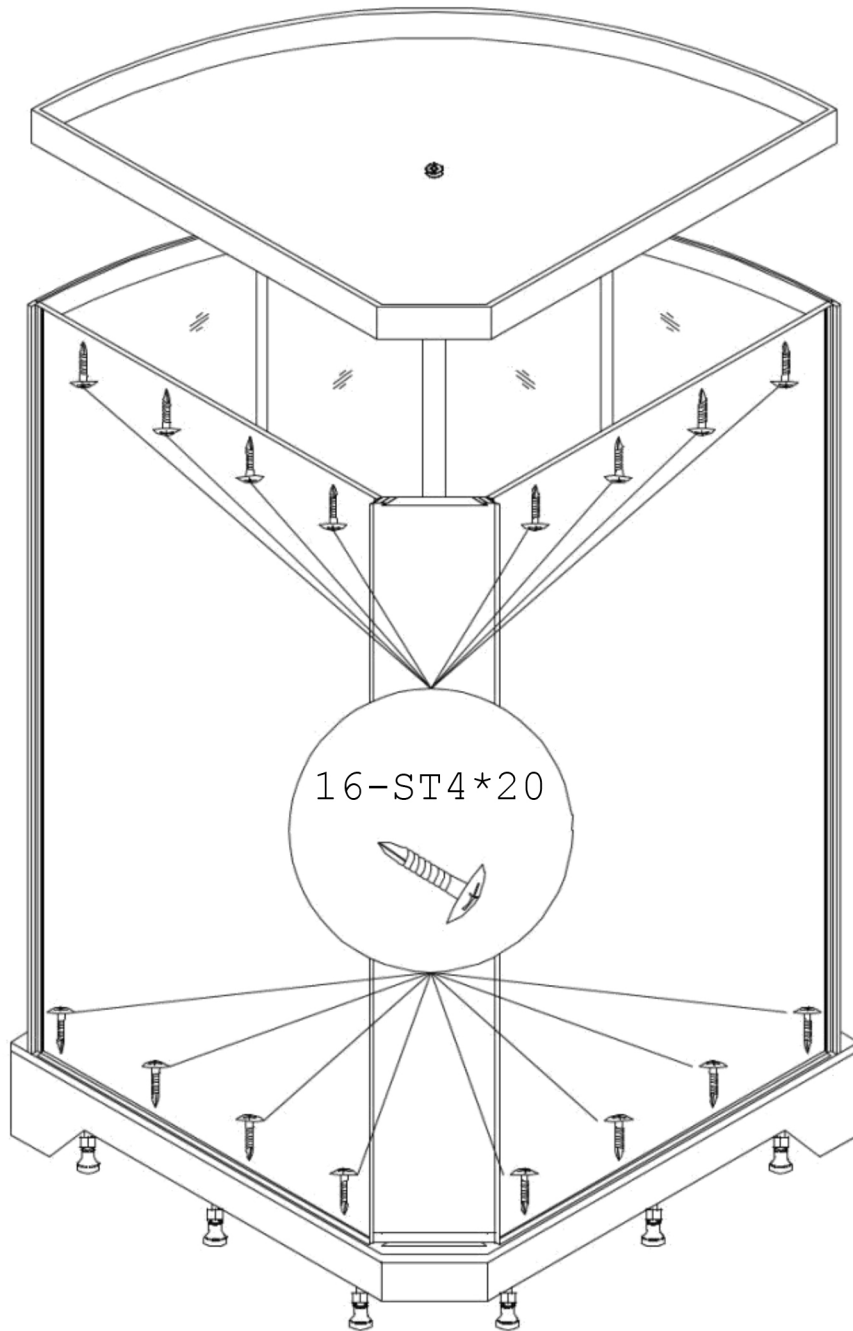
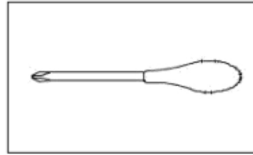

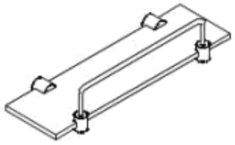

X1

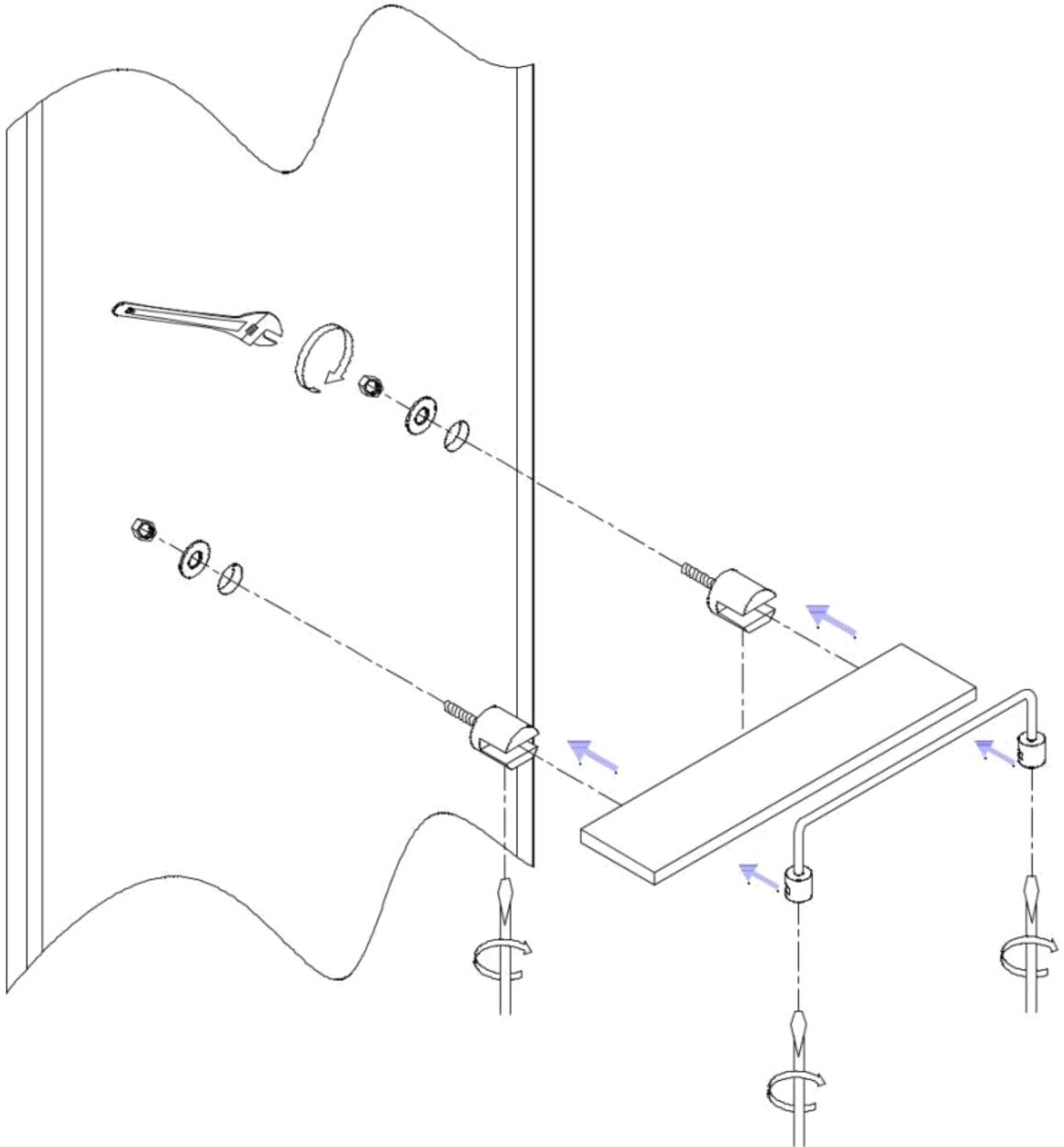
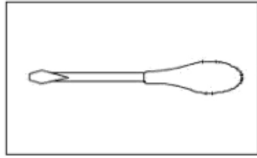
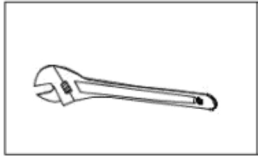

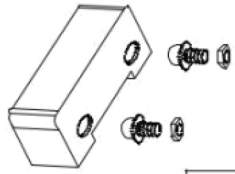

X1

