

# DOCCIA IDROMASSAGGIO

## Box doccia idromassaggio

In questo manuale è illustrata la procedura di montaggio della **cabina doccia idromassaggio** .  
Prima di effettuare il montaggio consigliamo di consultare il presente manuale di istruzioni per effettuare un montaggio a regola d'arte.

### Misure box doccia

800 × 800 × 2250mm

900 × 900 × 2250mm

Per richiedere un ricambio o un accessorio del **box doccia**

Scrivi a [info@disegnarecasa.com](mailto:info@disegnarecasa.com)

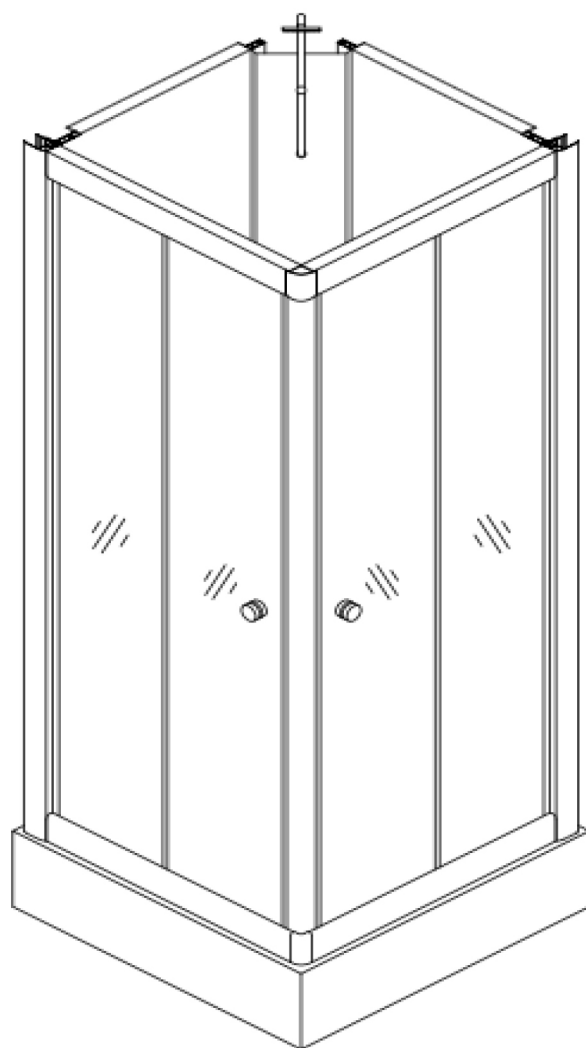

1/4

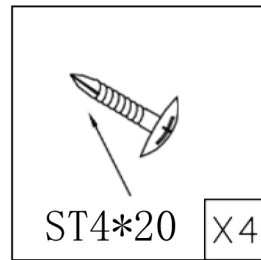
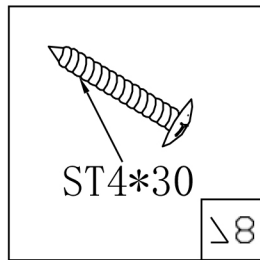
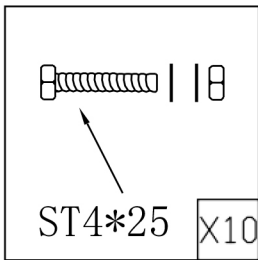
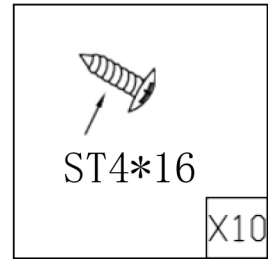
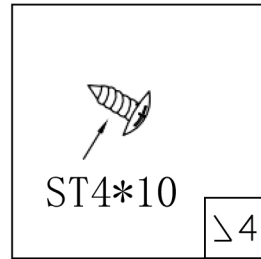
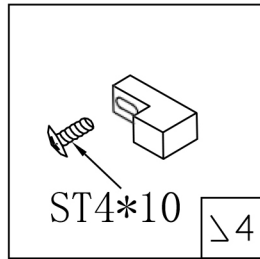
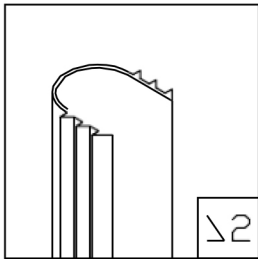
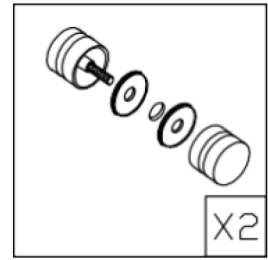
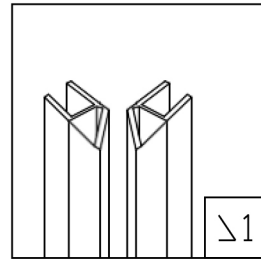
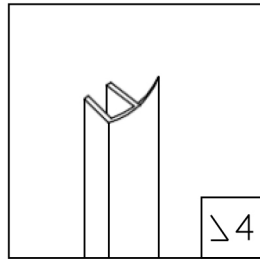
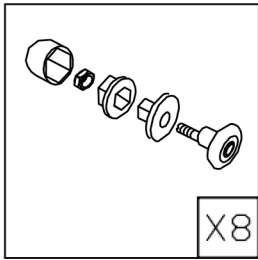
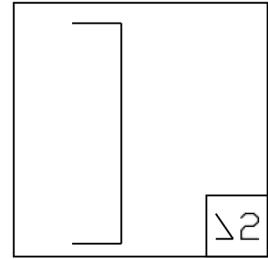
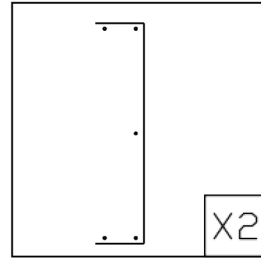
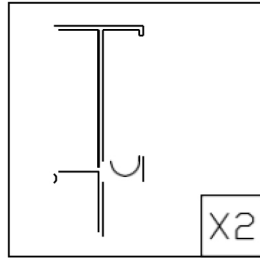
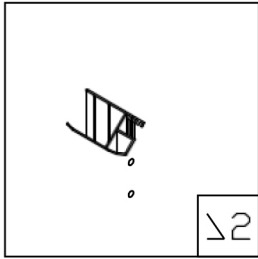
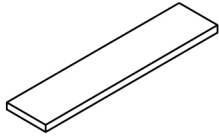

2/4

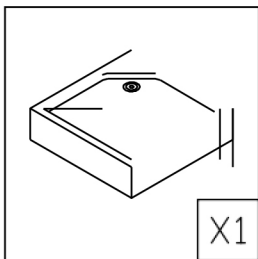
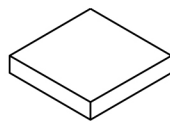

3/4

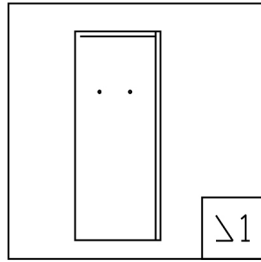
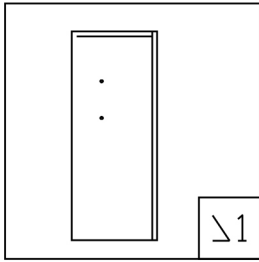
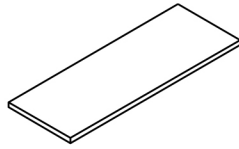

4/4

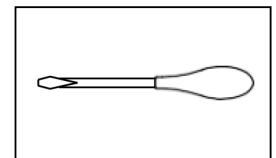
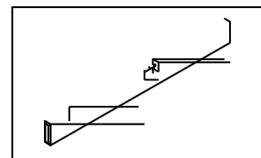
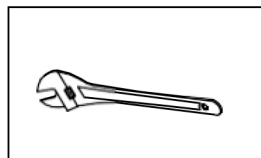
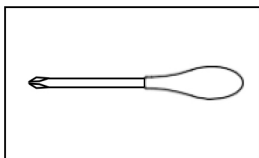
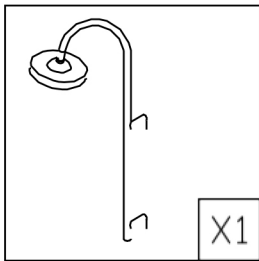
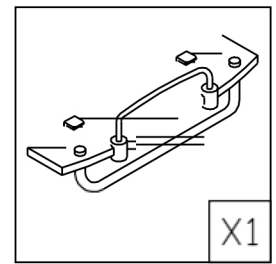
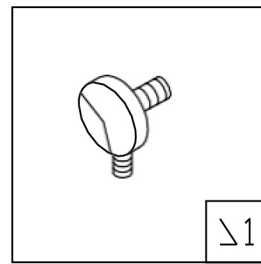
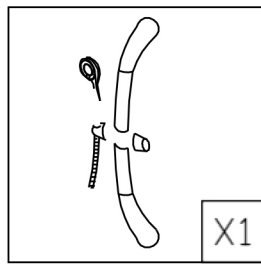
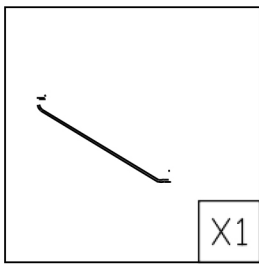
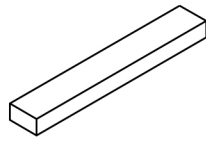



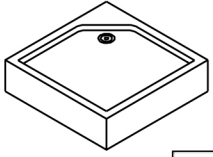

X1

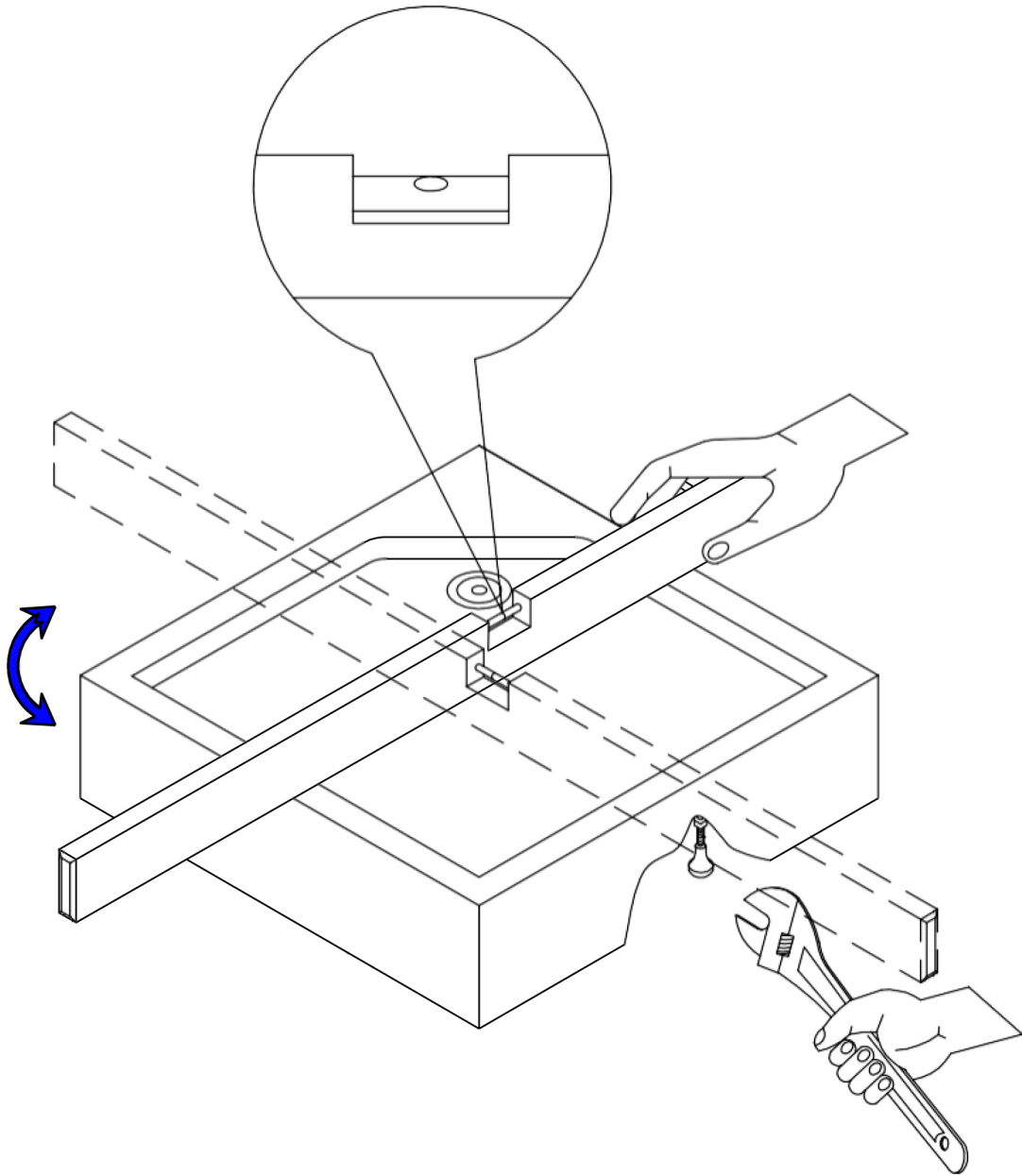
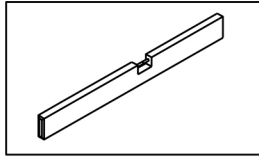
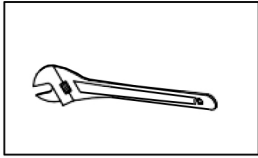

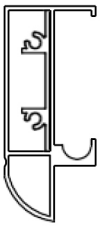

X2



ST4\*10

X4

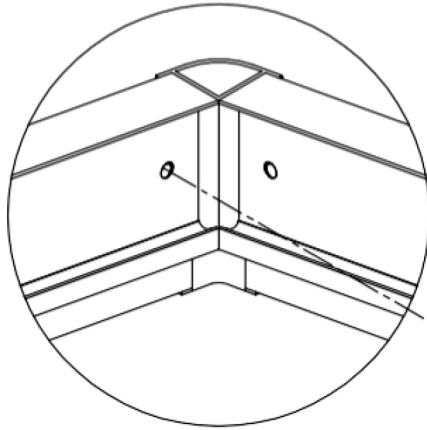
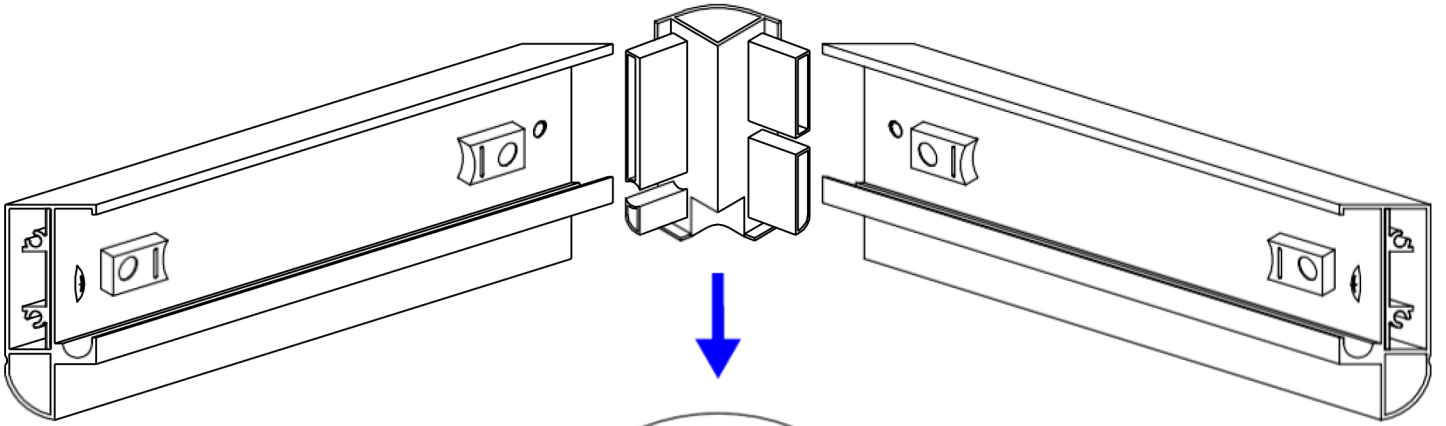
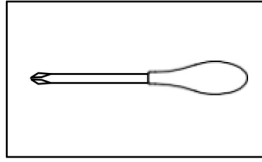

4- $\varnothing$ 2.8mm

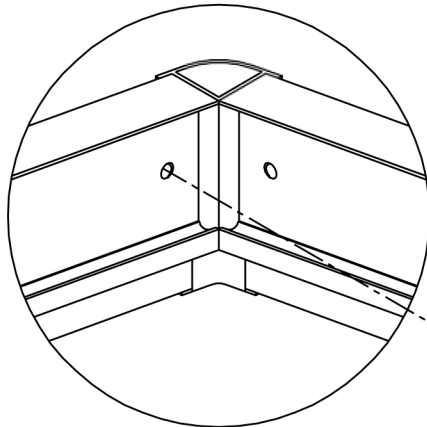
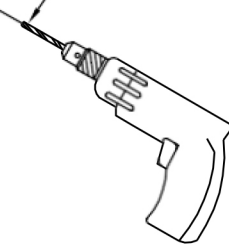

ST4\*10

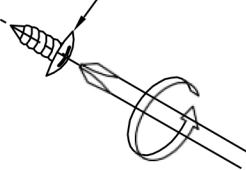

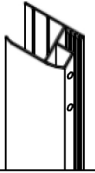

X2

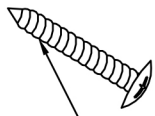

ST4\*30

X8

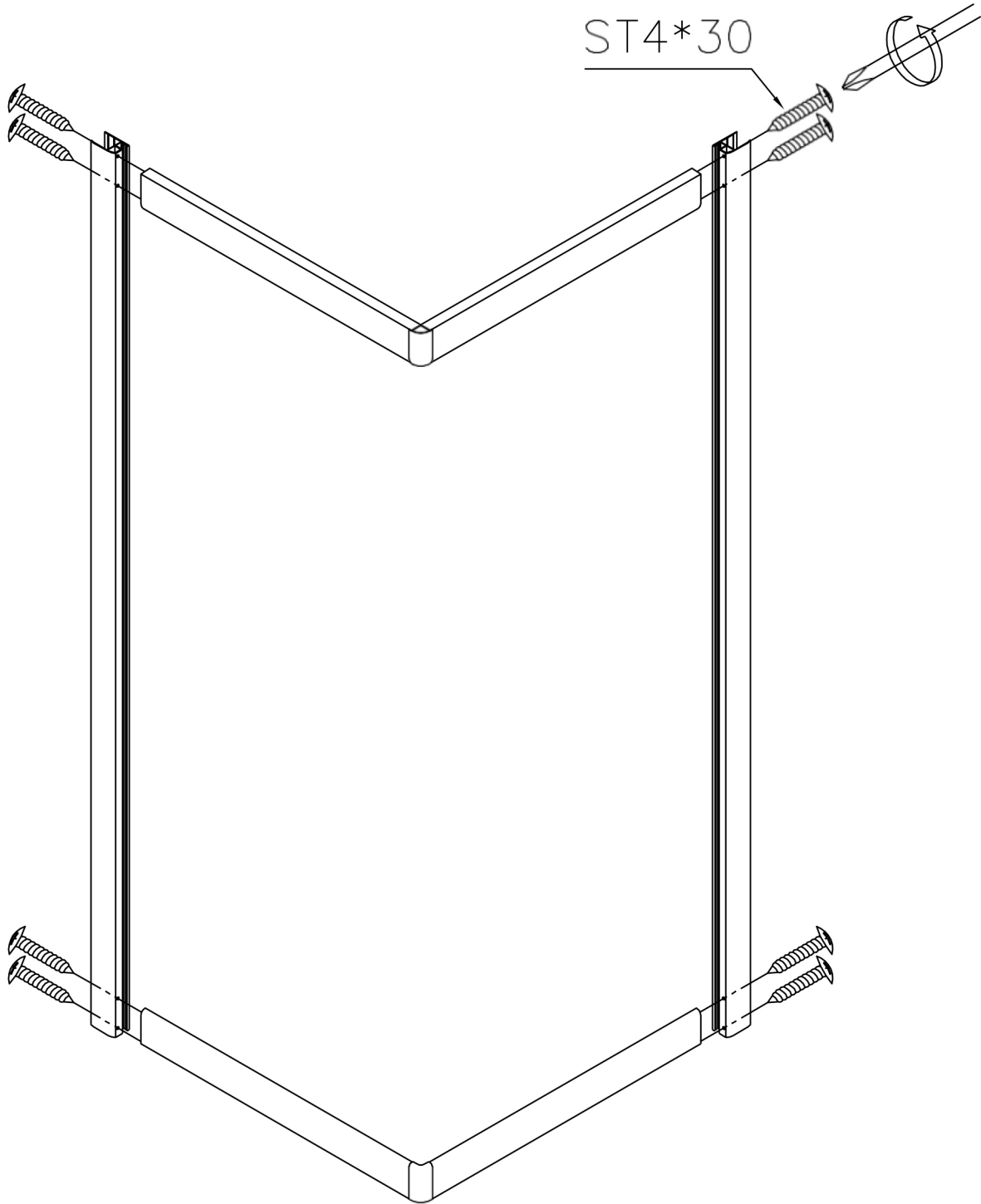
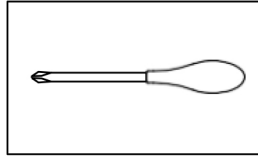

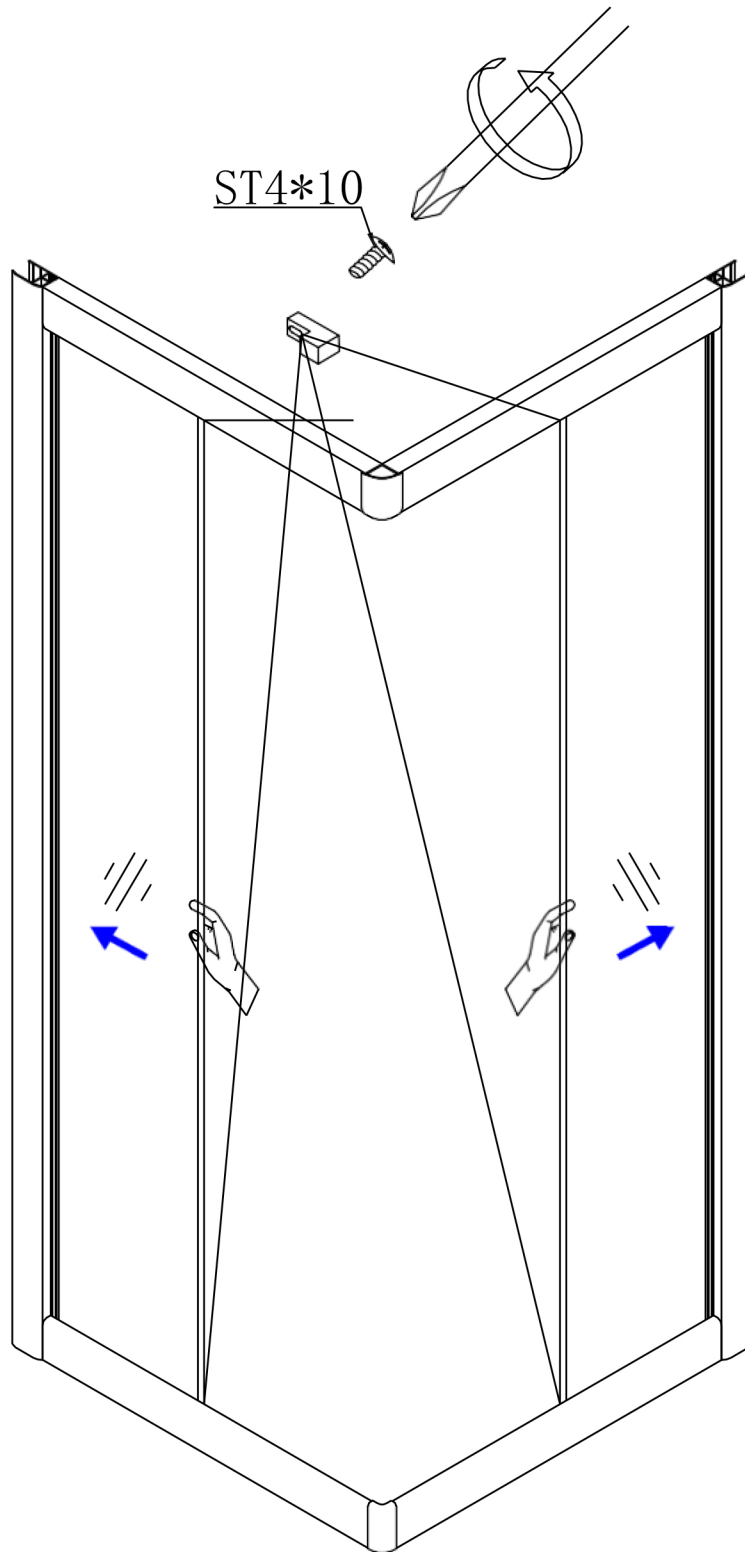
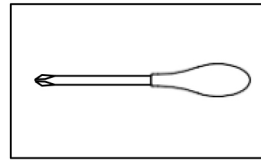
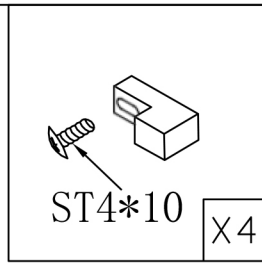
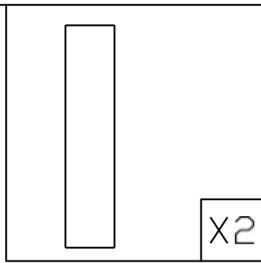
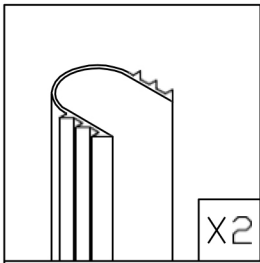

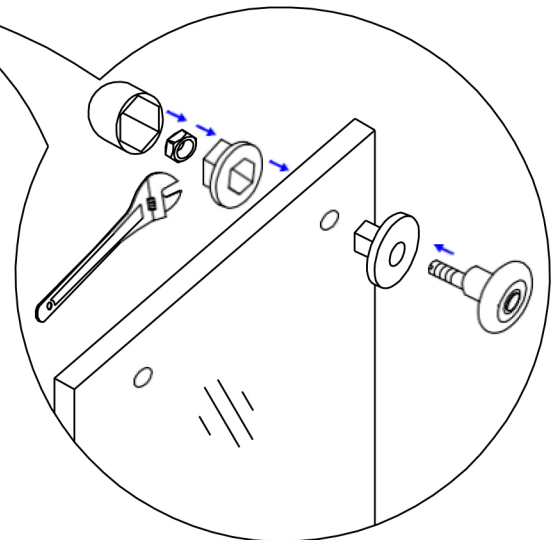
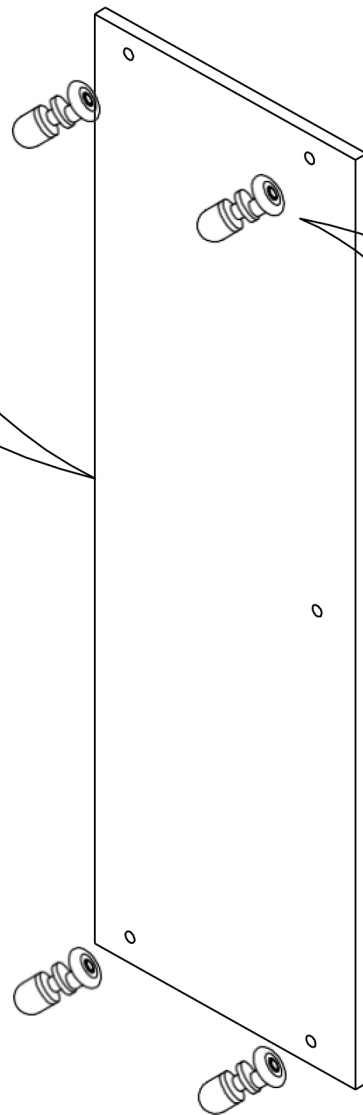
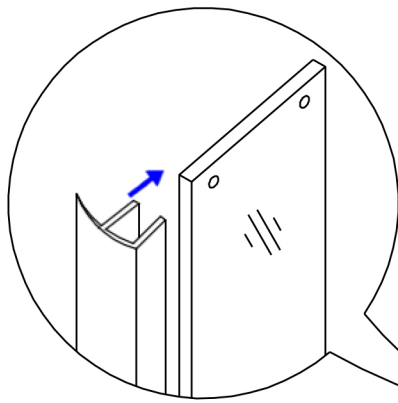
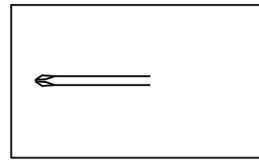
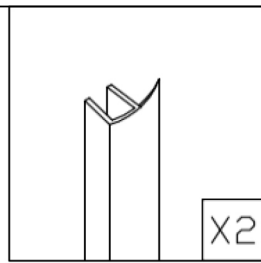
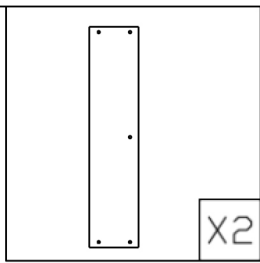
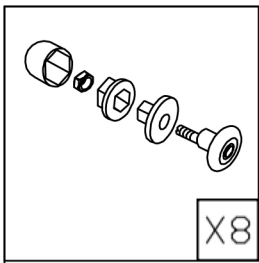

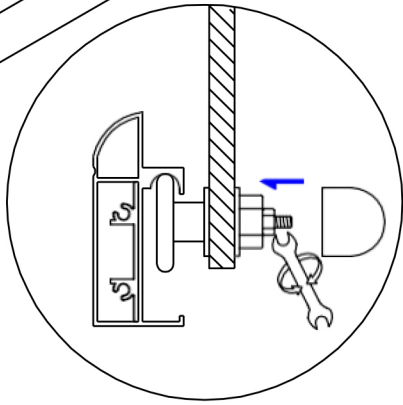
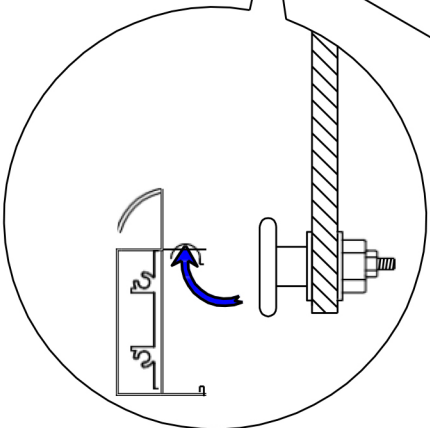
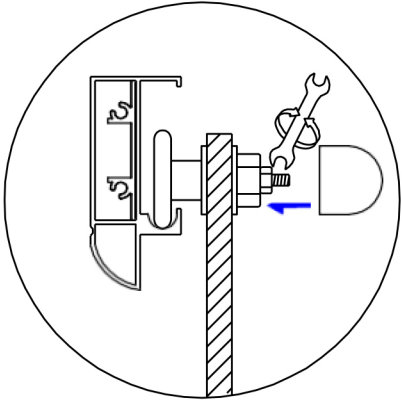
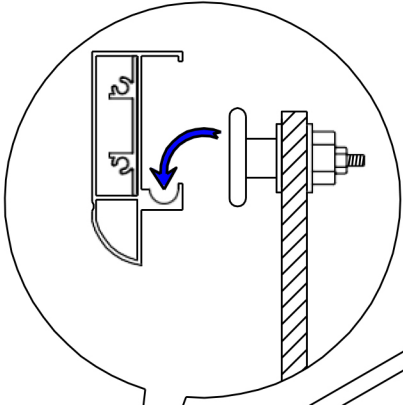
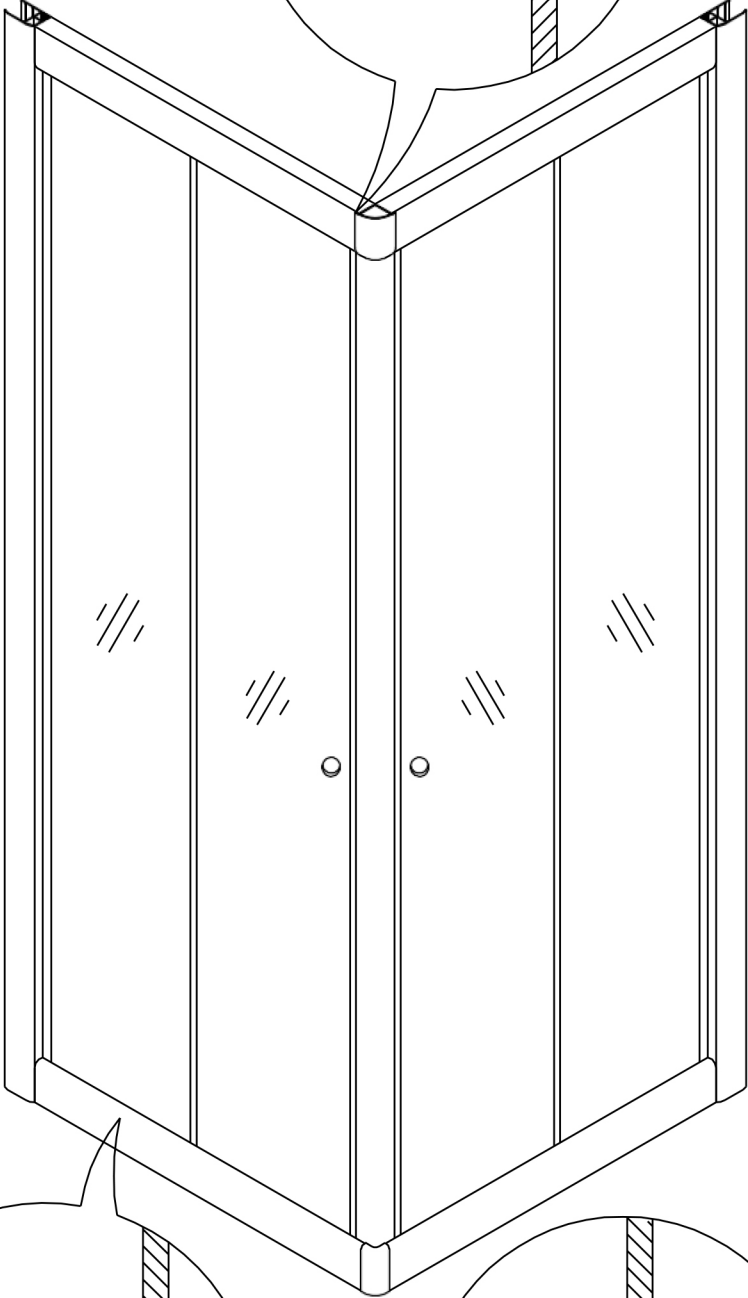

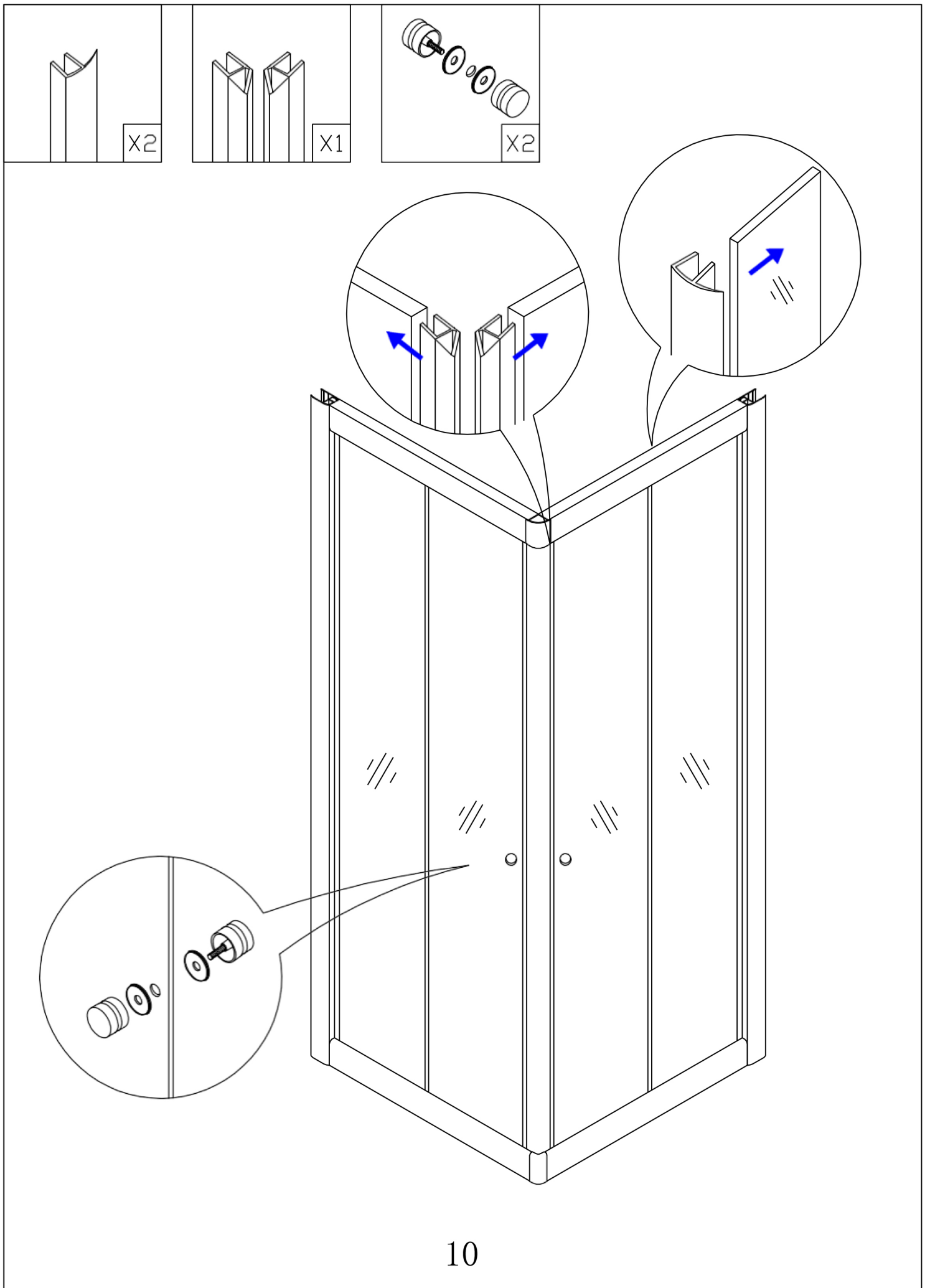

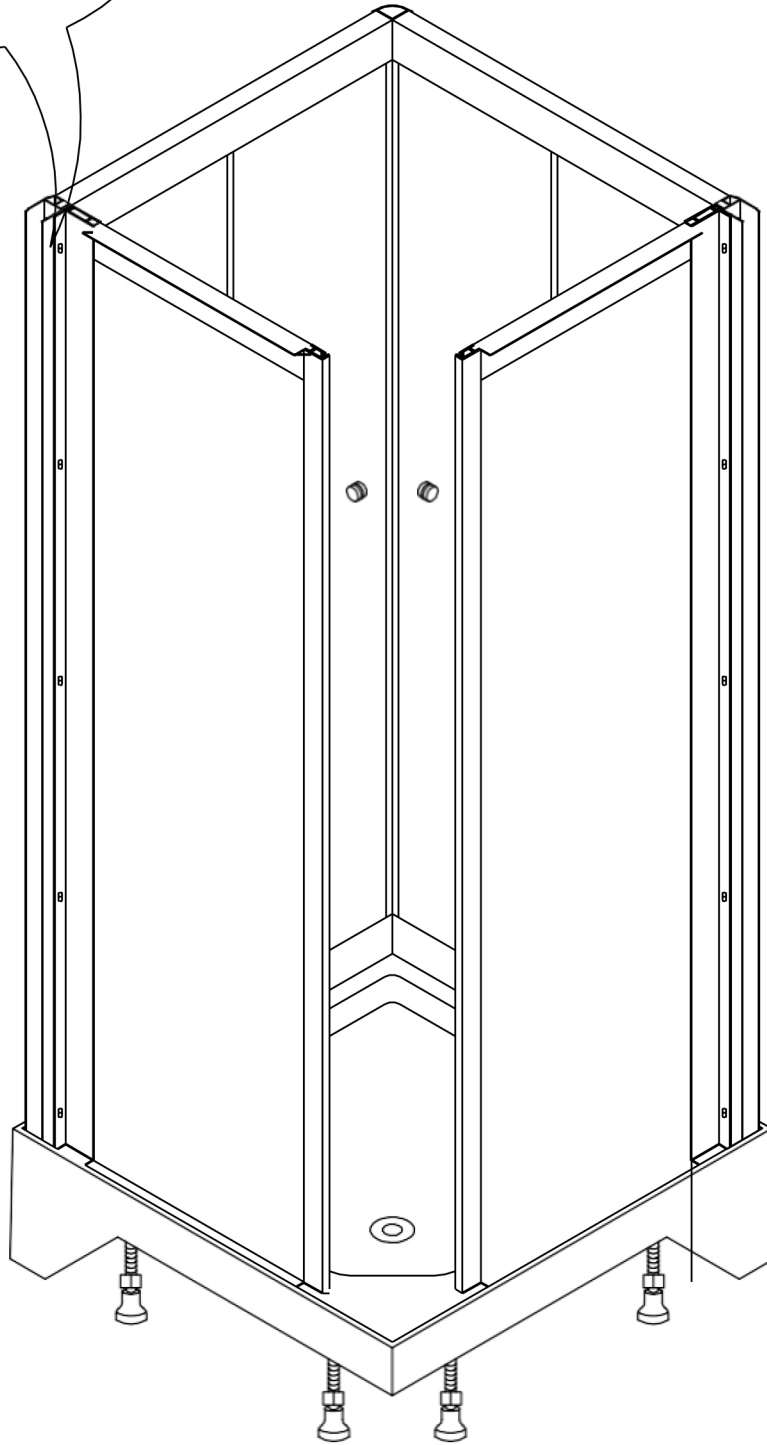
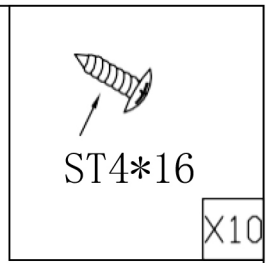
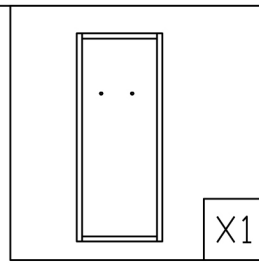
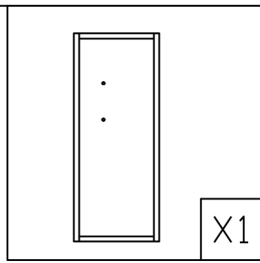
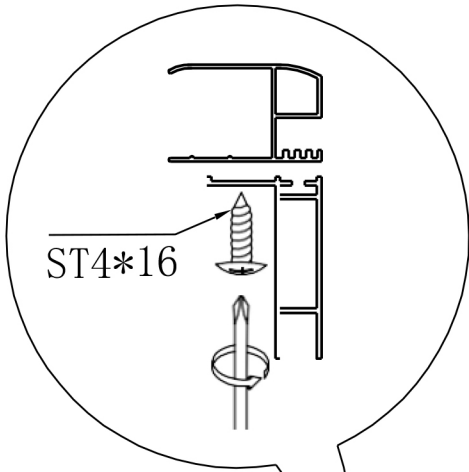



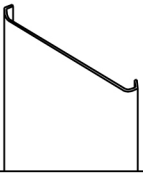

X1



ST4\*25

X10

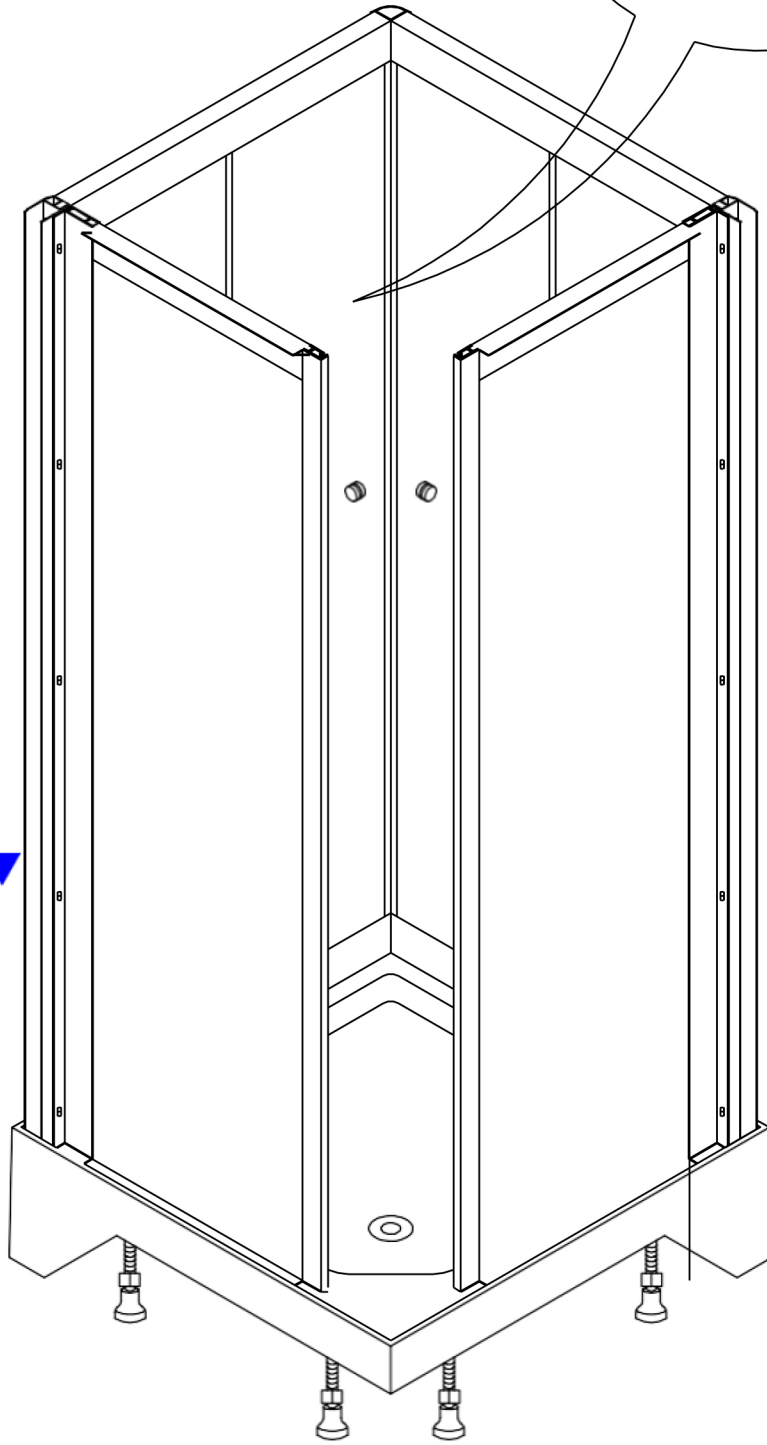
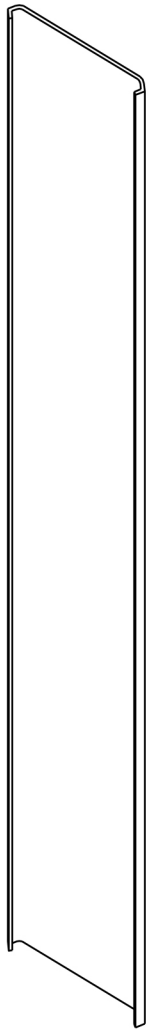
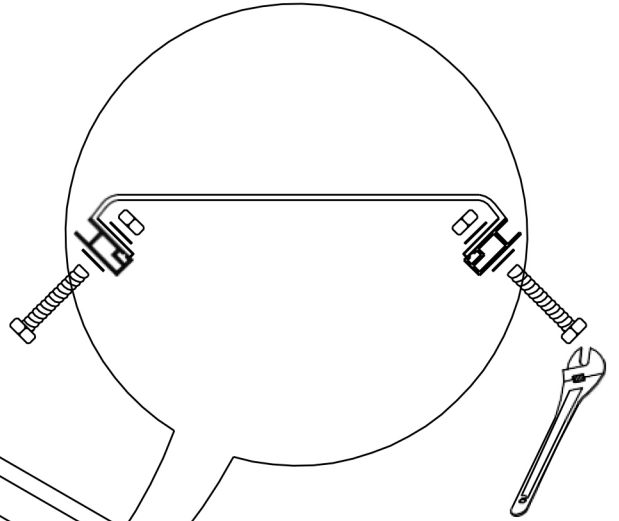



ST4\*20

X4

4-ST4\*20

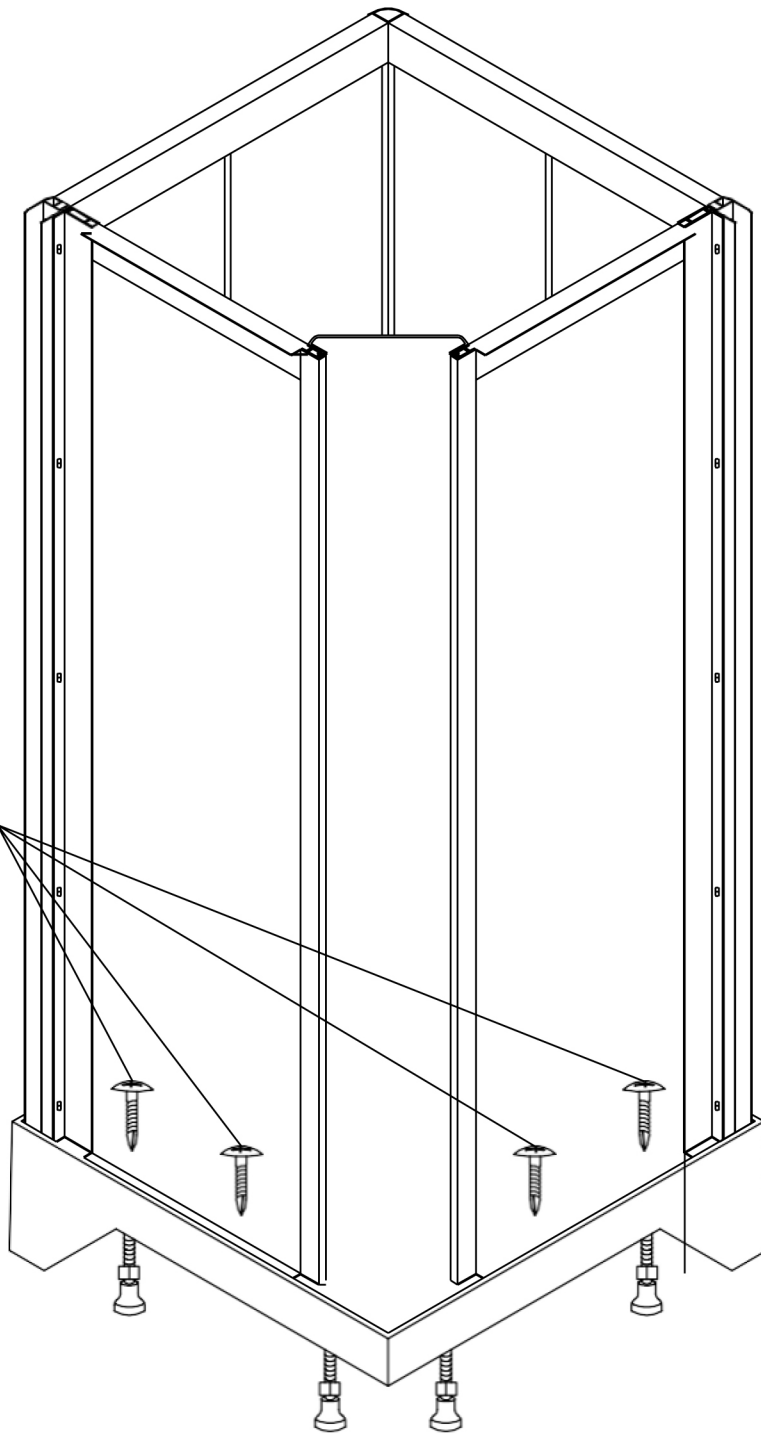

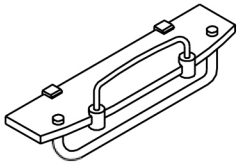

X1

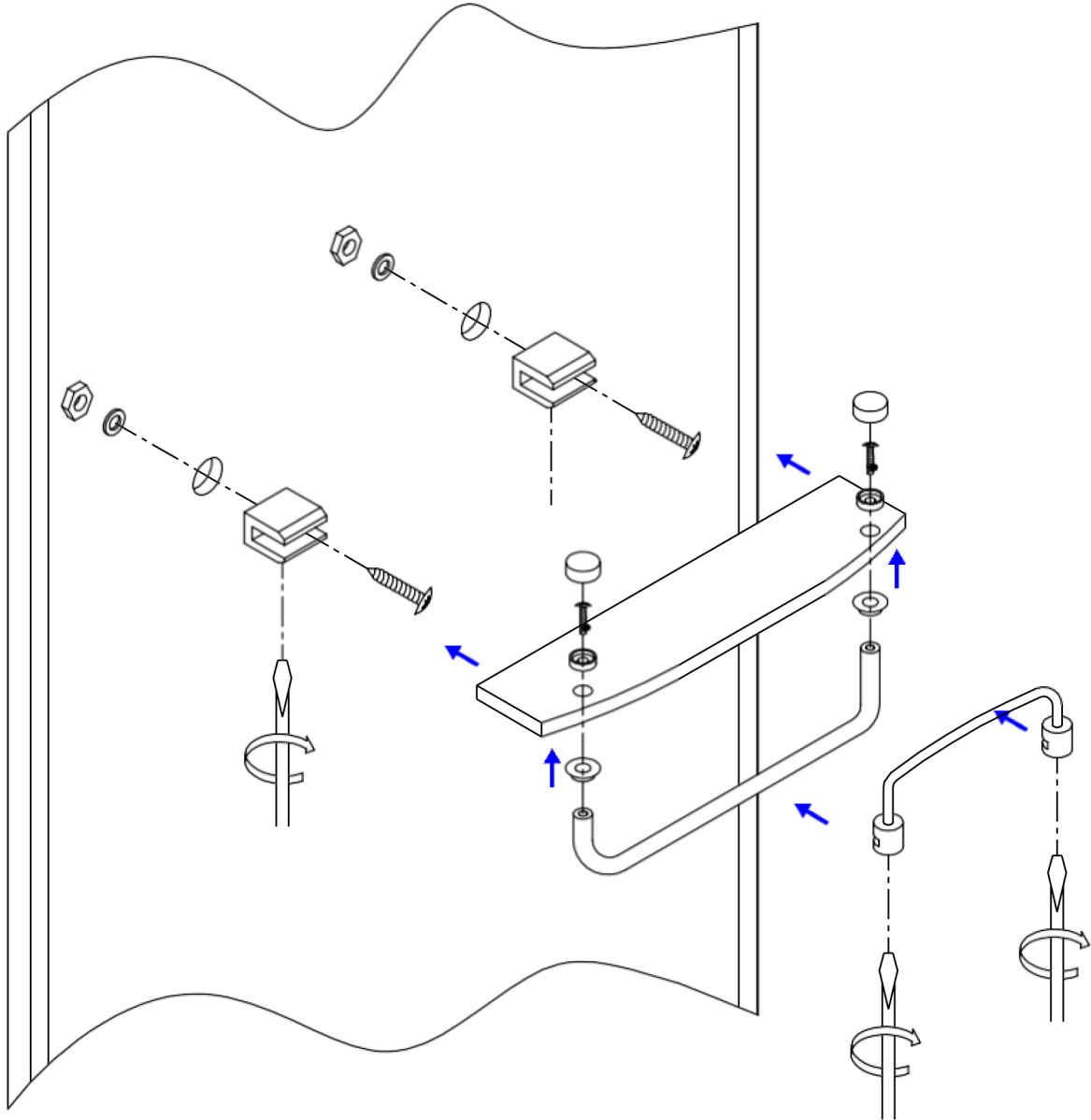
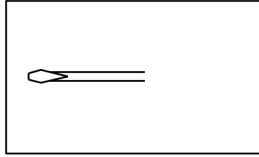
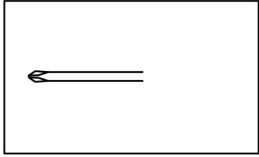



X1



X1

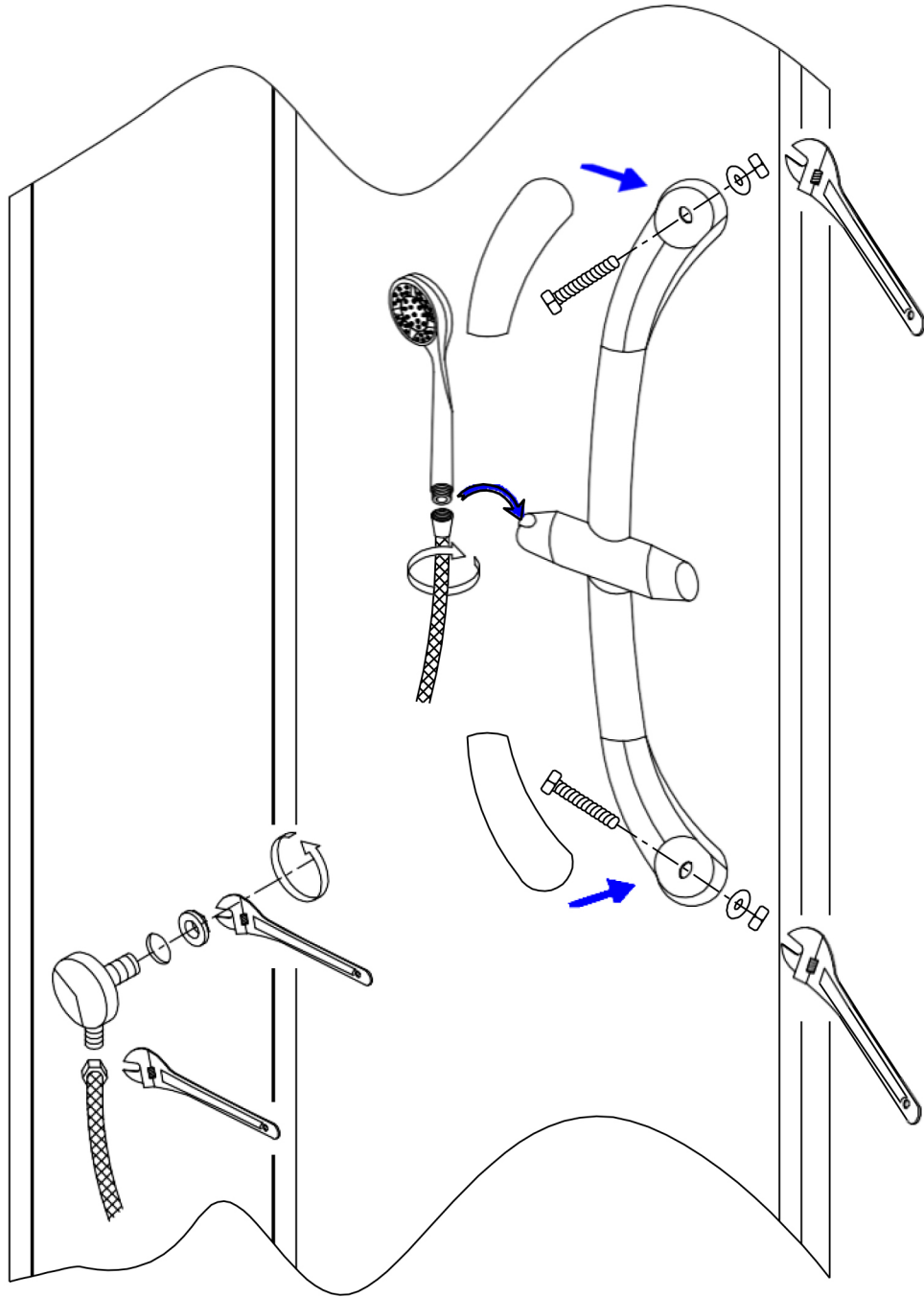
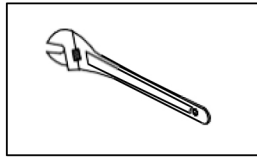

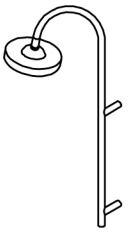

X1

