

DOCCIA IDROMASSAGGIO

In questo manuale è illustrata la procedura della

Cabina Doccia Idromassaggio 09002.

Prima di montare il **box doccia** consigliamo di consultare il presente manuale di istruzioni per realizzare il montaggio correttamente.

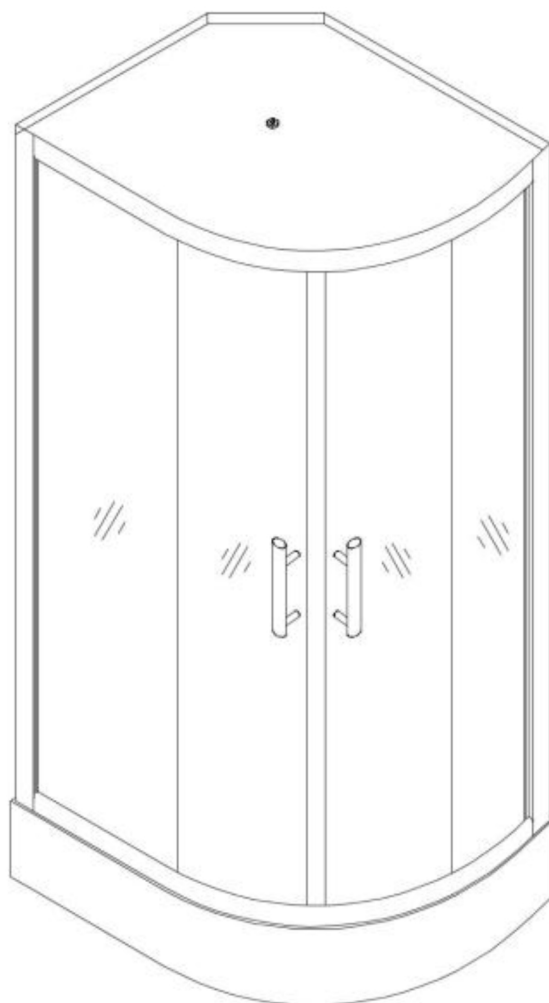

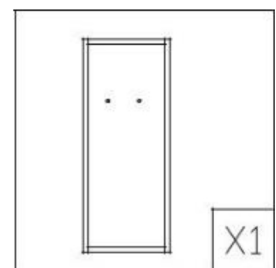
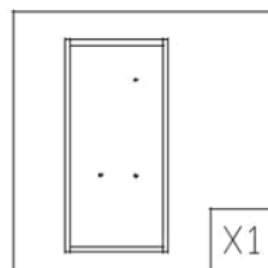
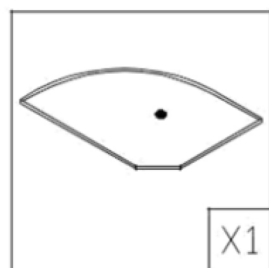
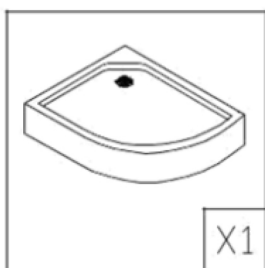
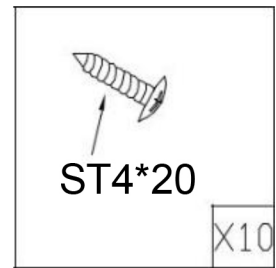
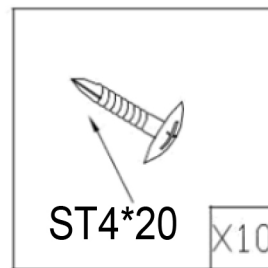
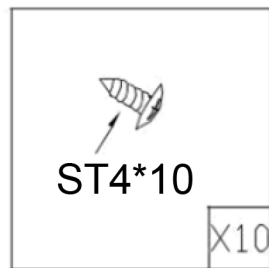
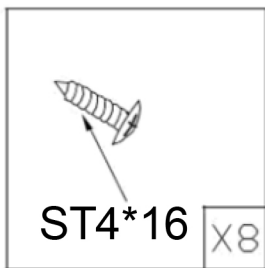
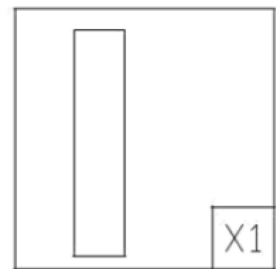
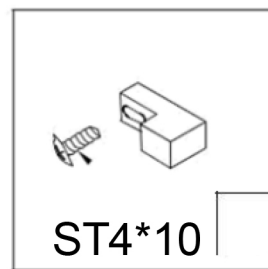
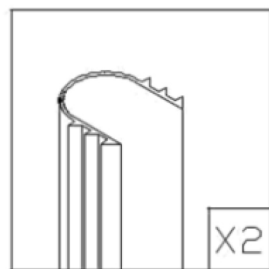
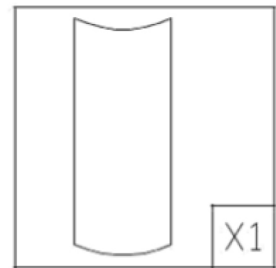
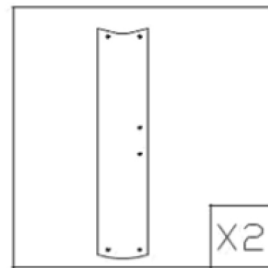
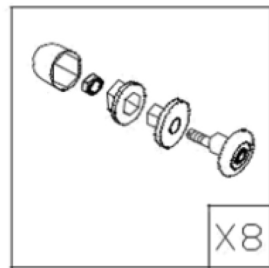
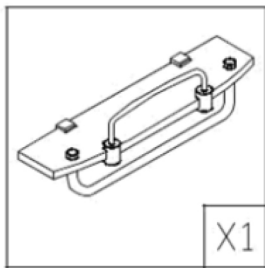
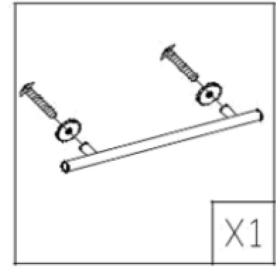
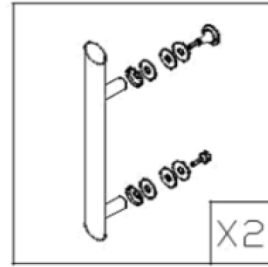
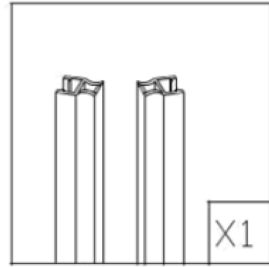
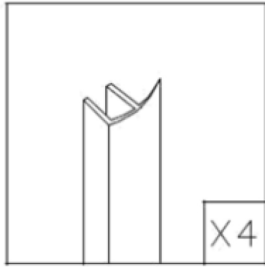
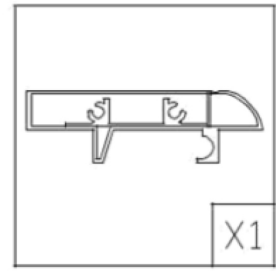
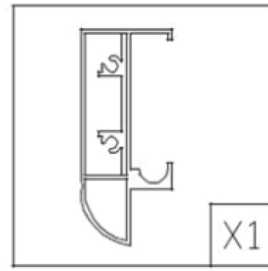
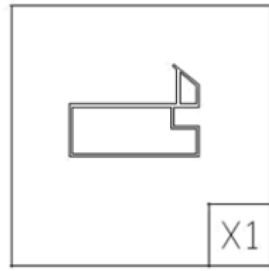
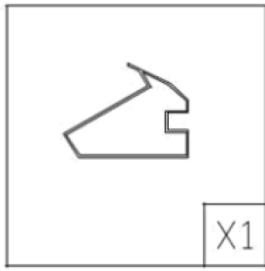

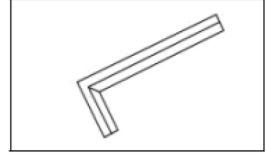
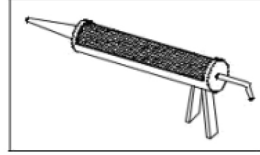
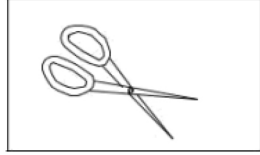
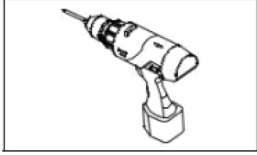
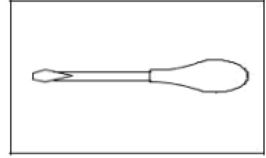
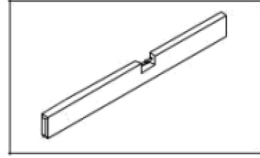
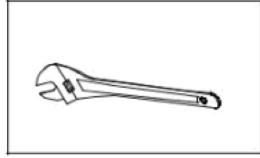
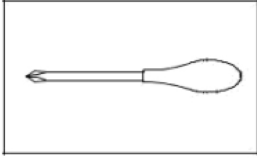

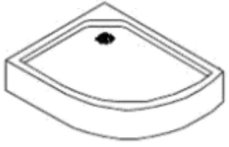

X1

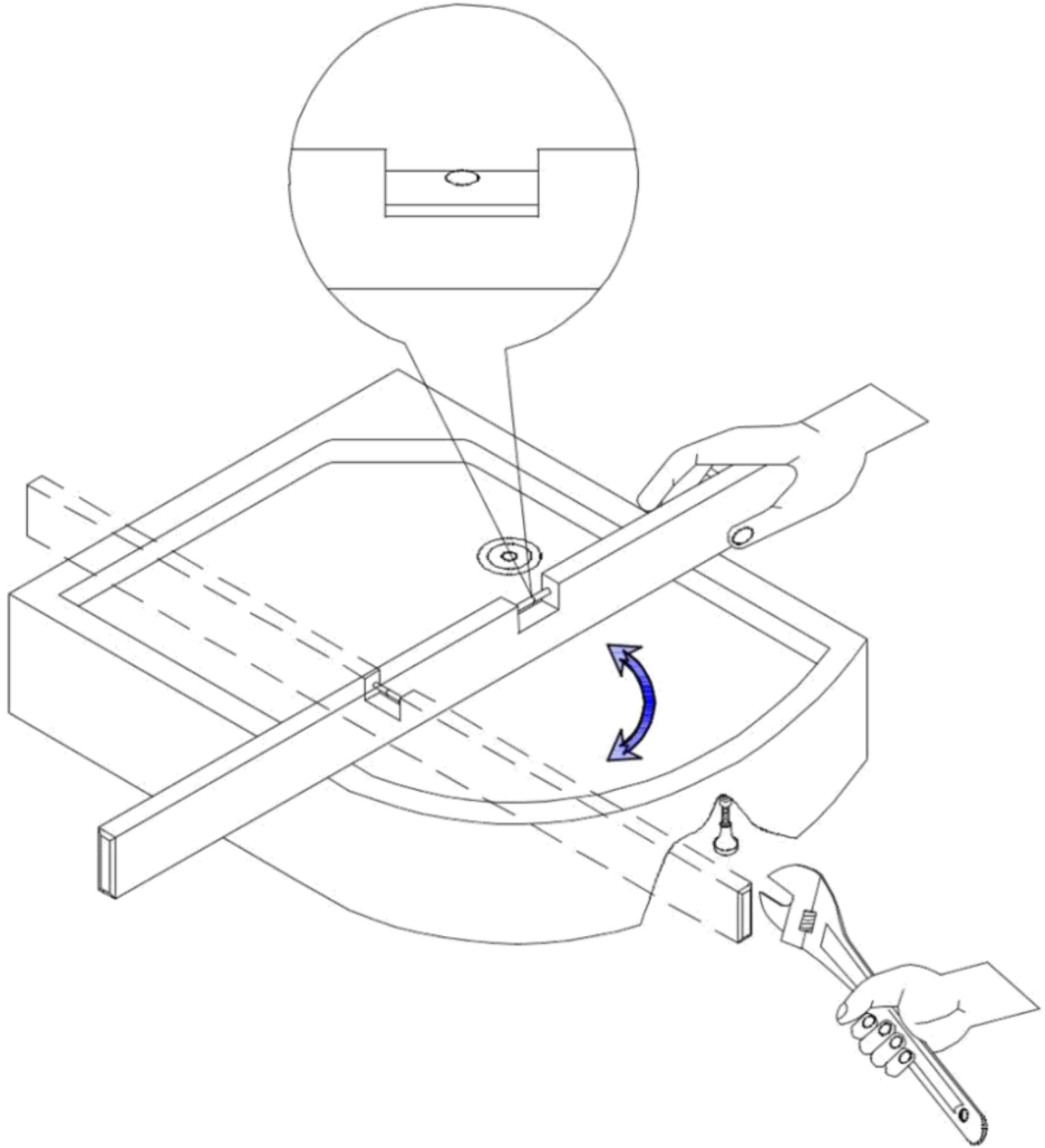
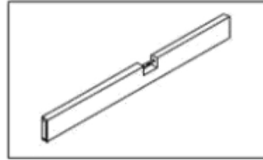
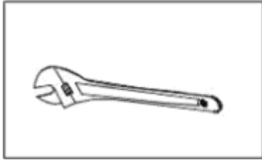

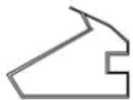

X1

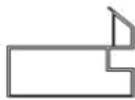

X1



X1

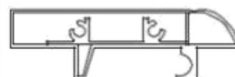

X1



ST4*16

8

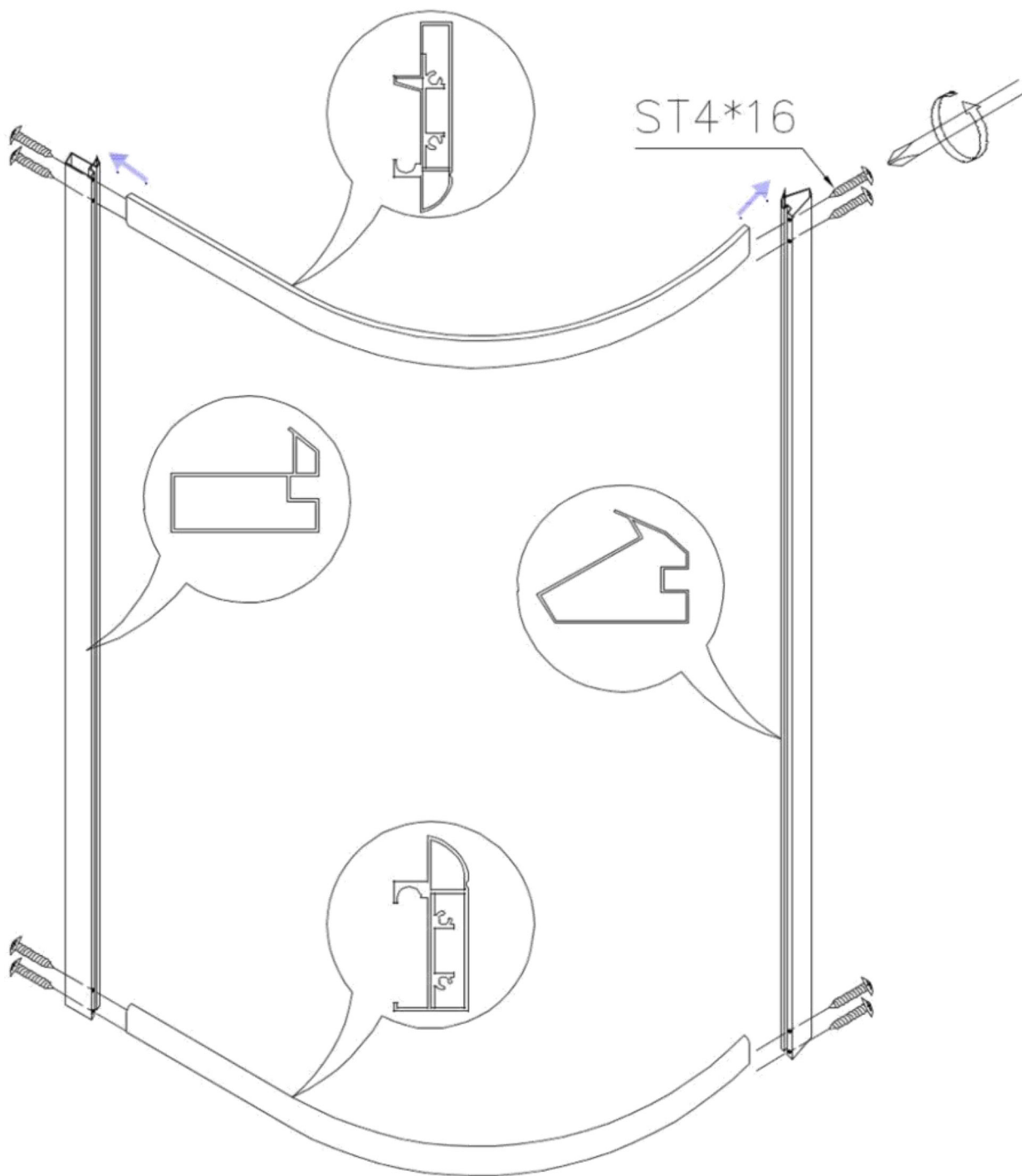

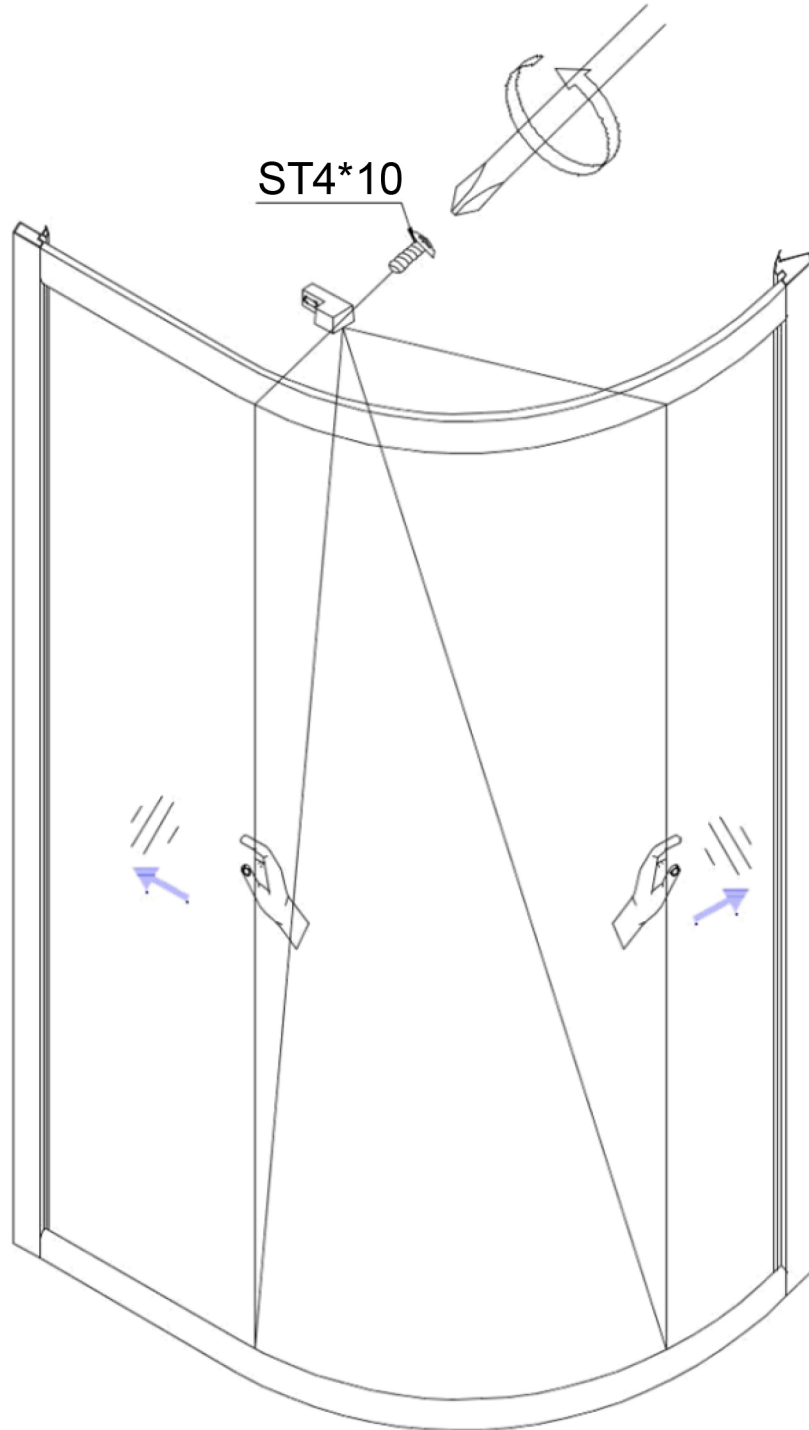
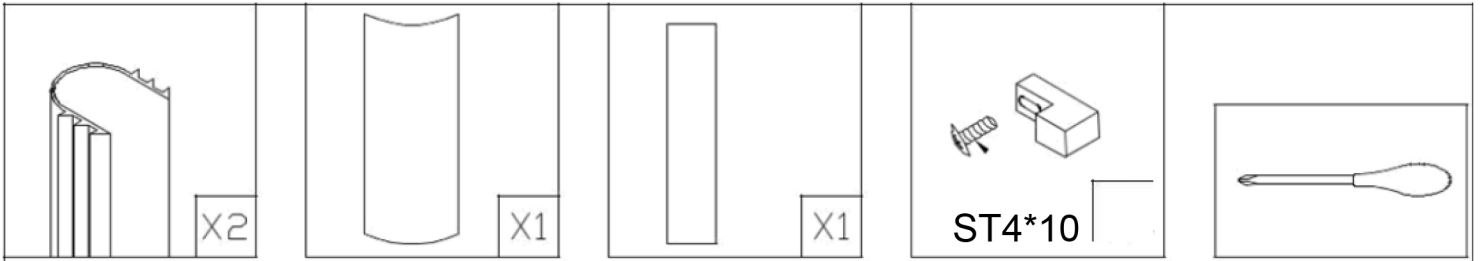

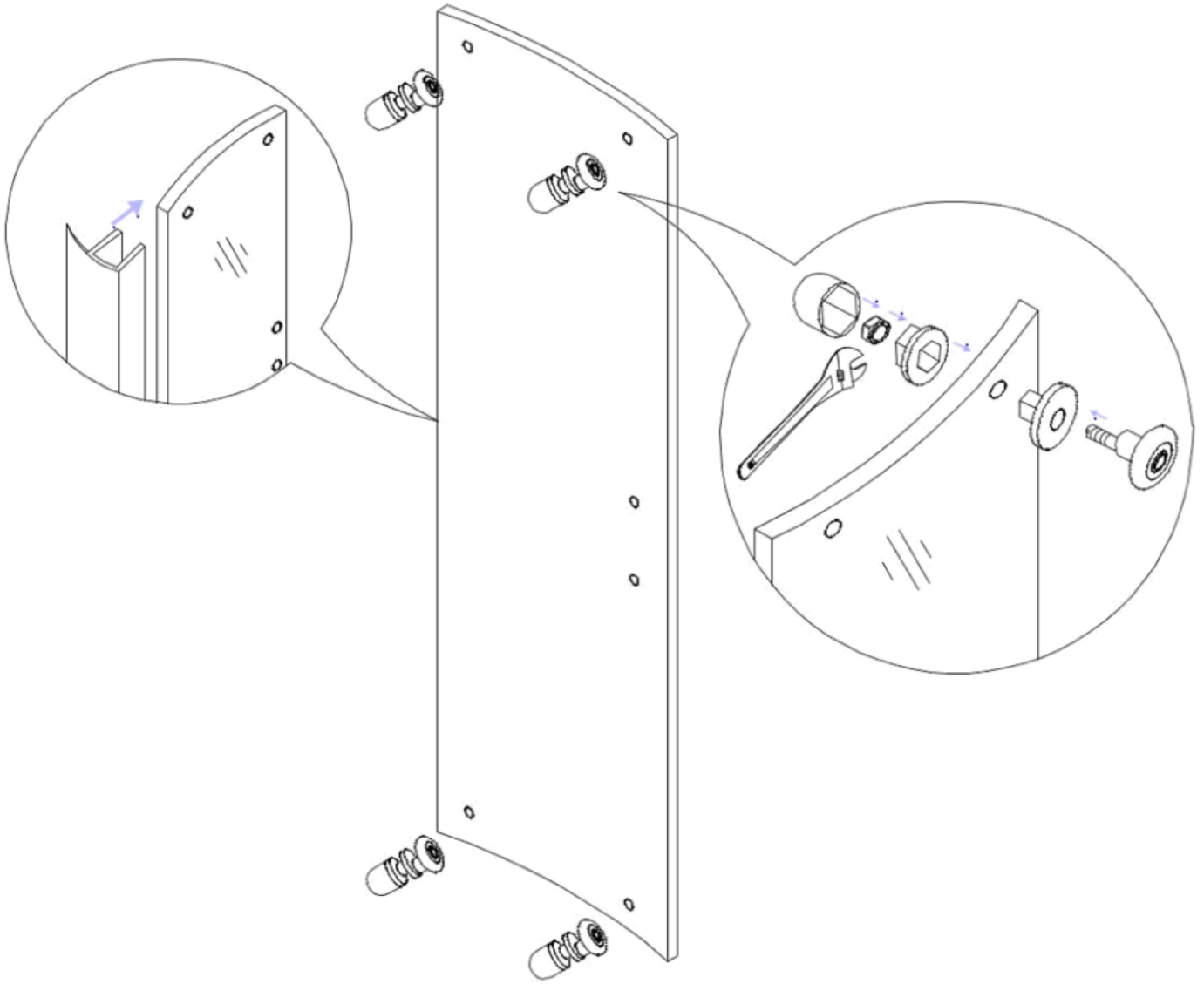
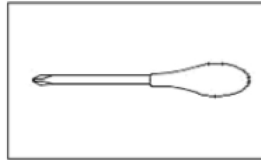
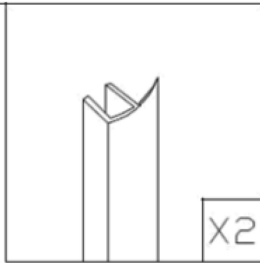
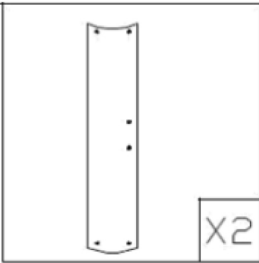
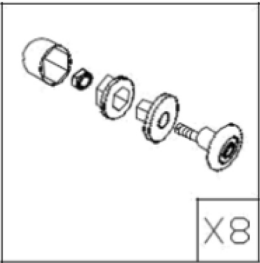

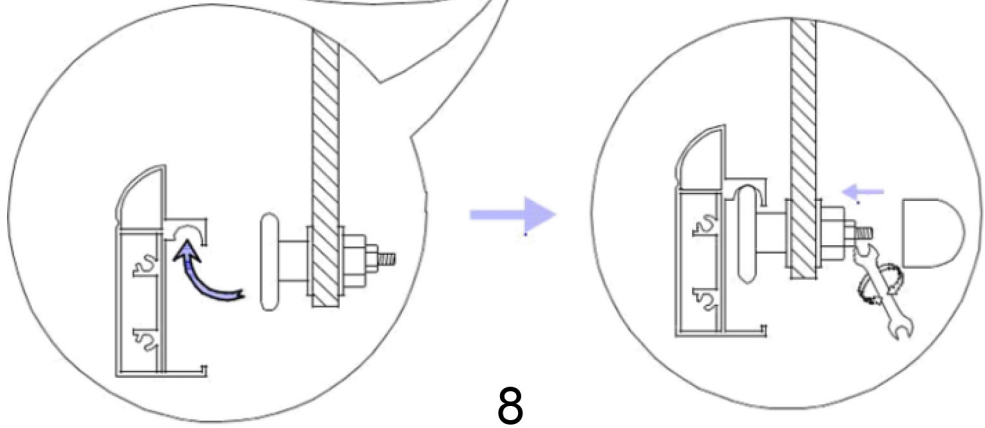
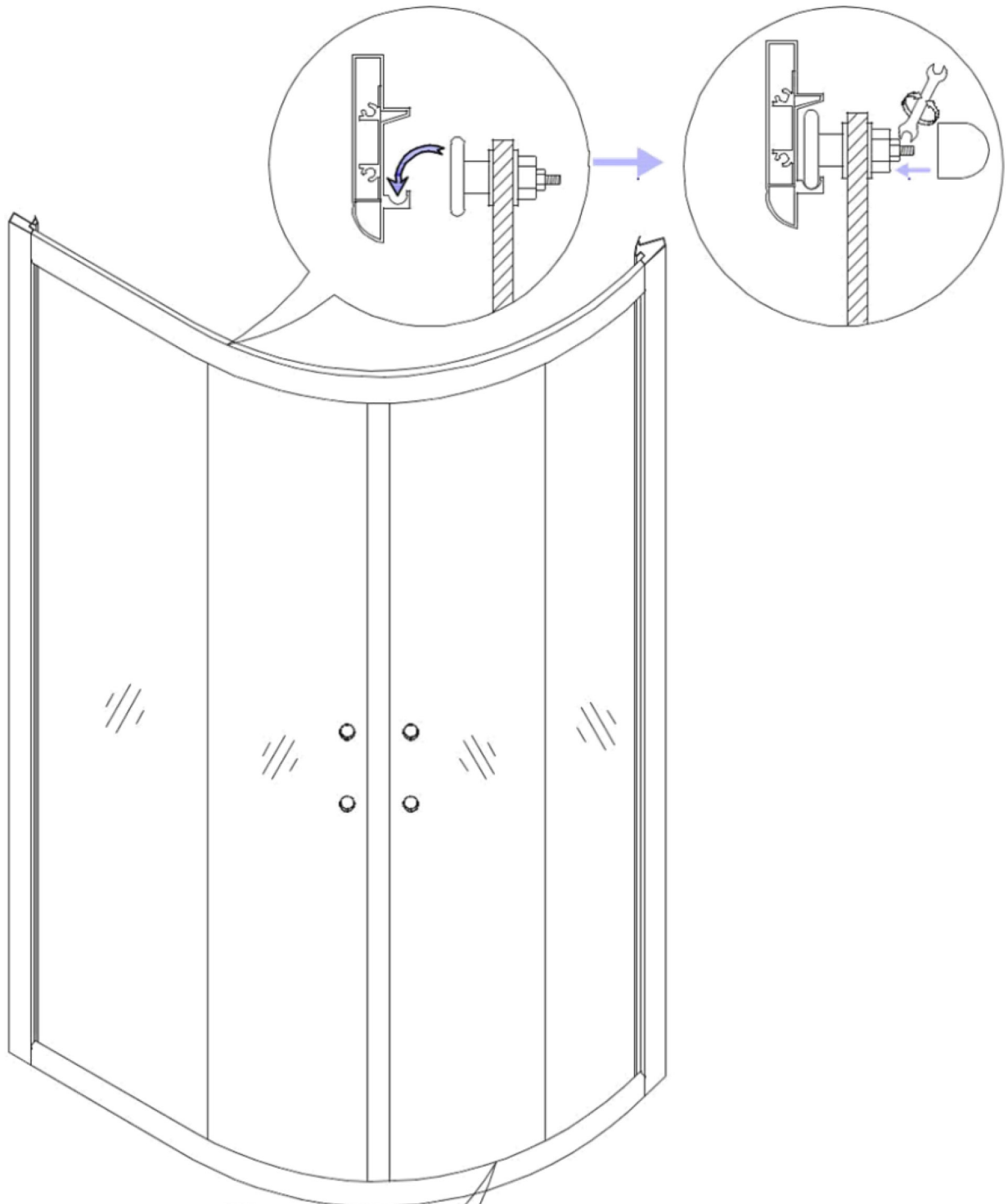

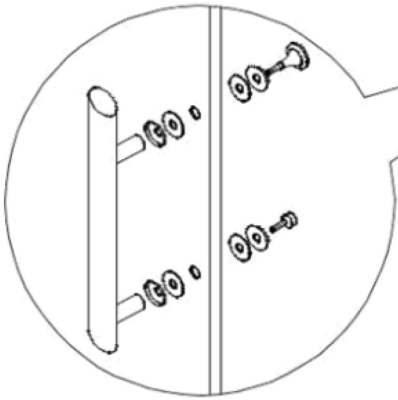
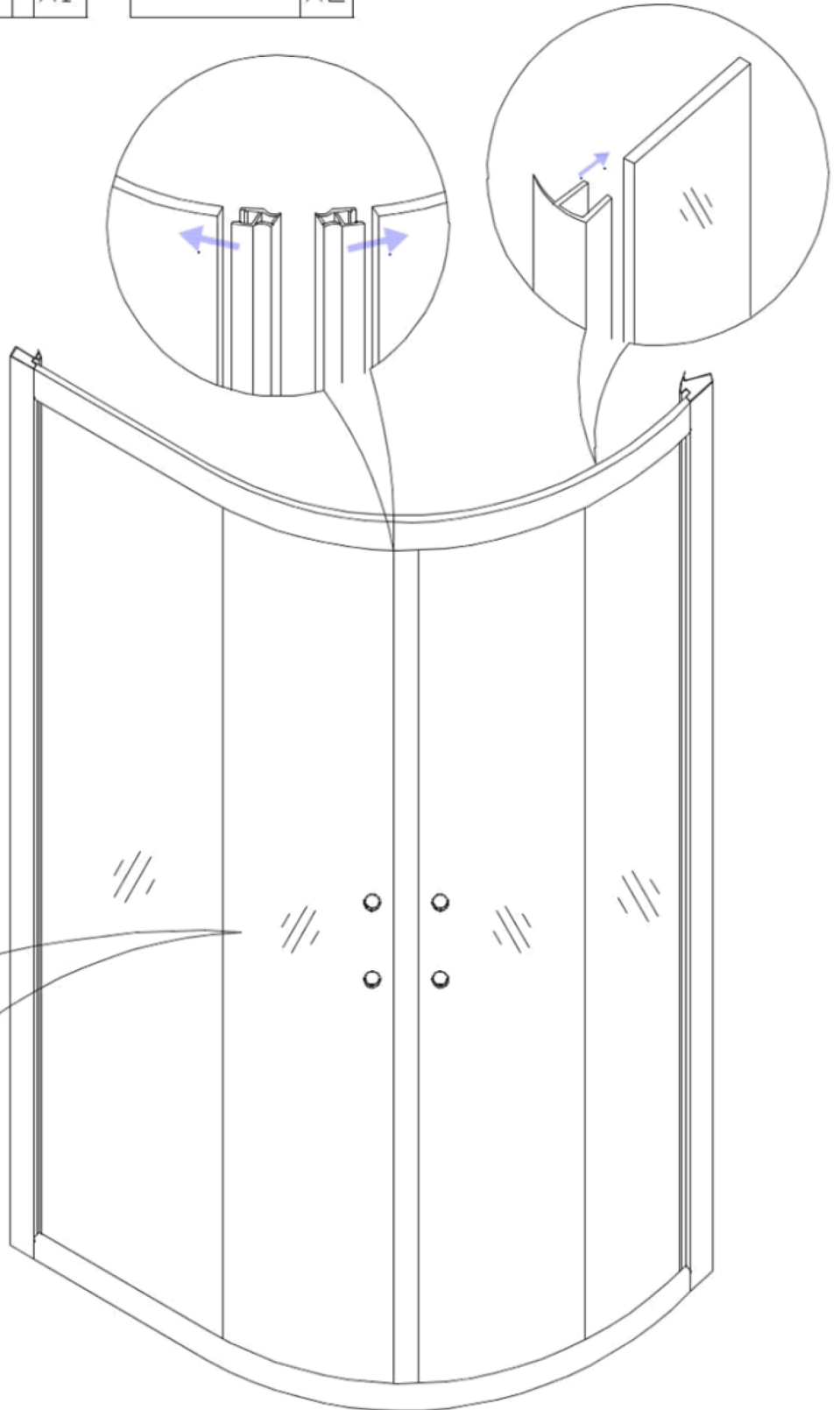
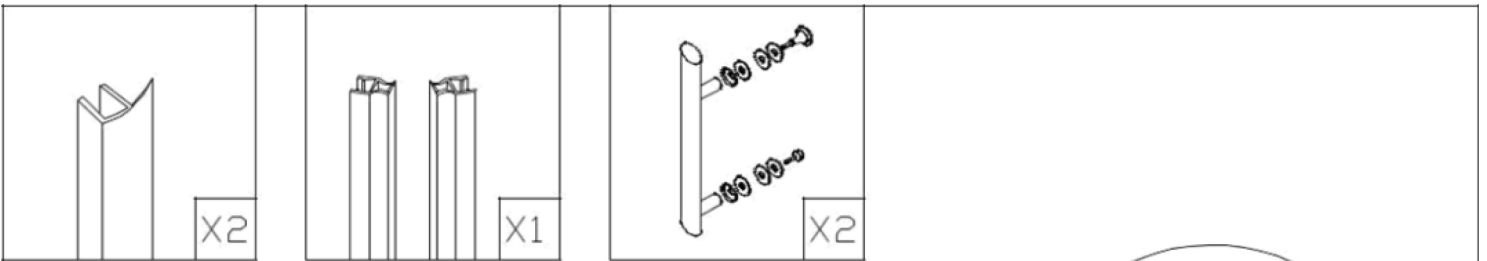



X1



X1



ST4*10

X10

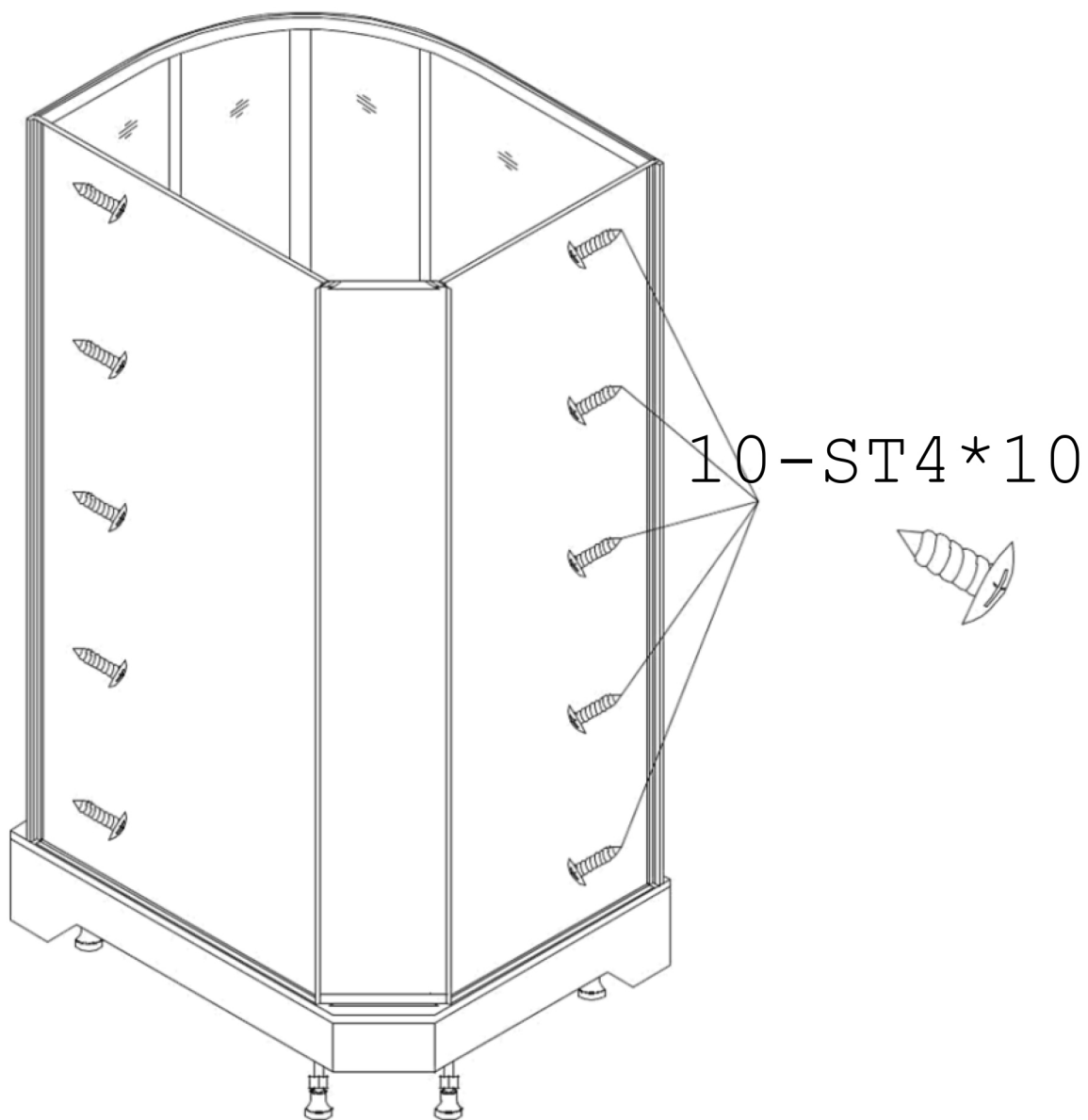
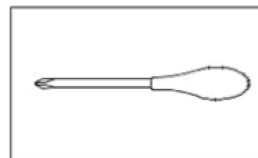



ST4*20

X10

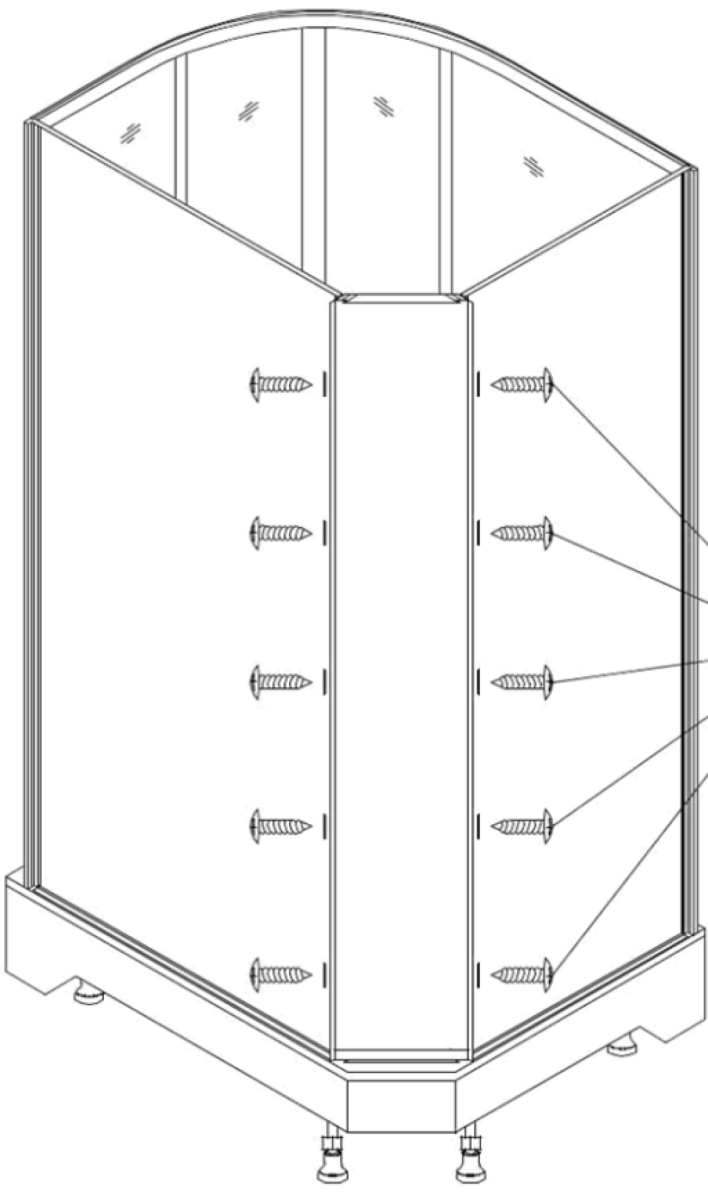
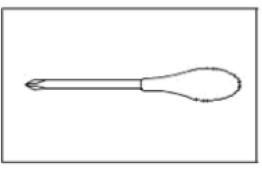

10-ST4*20



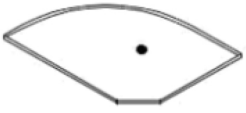

X1



ST4*20

X10

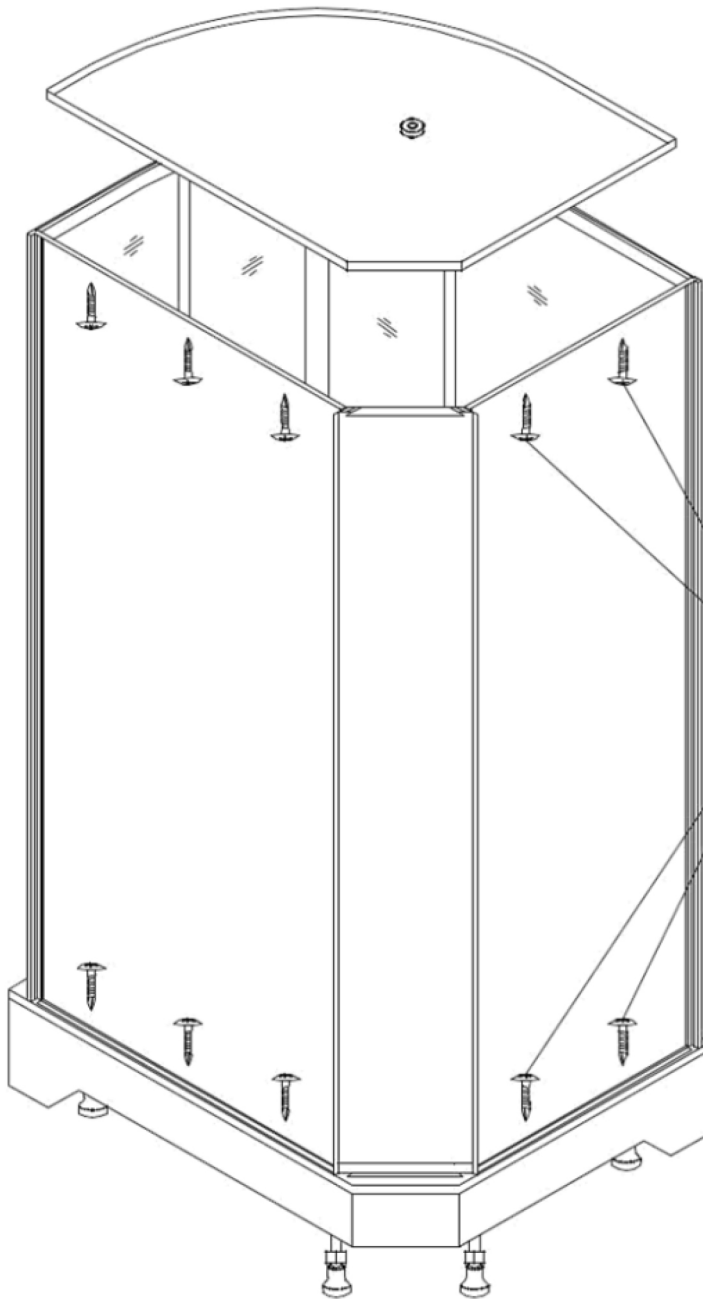
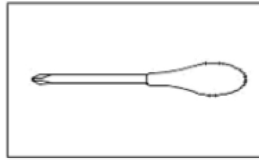

10-ST4*20



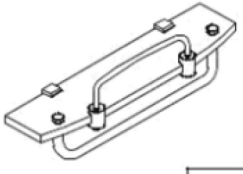

X1

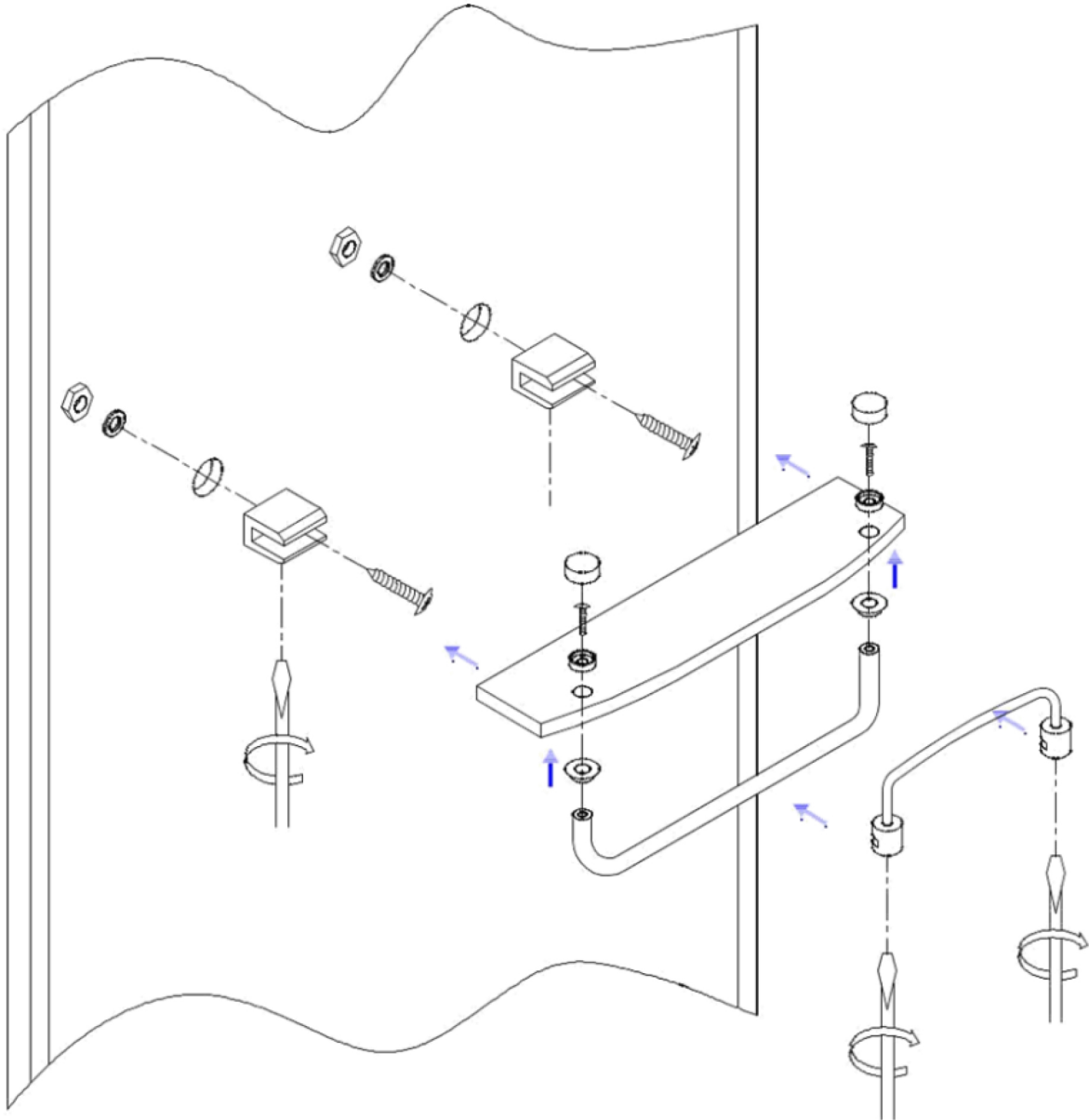
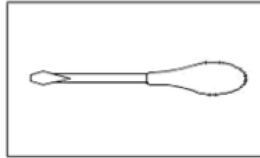
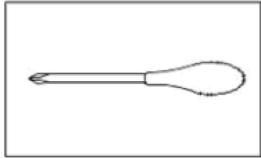

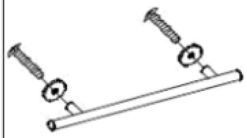

X1

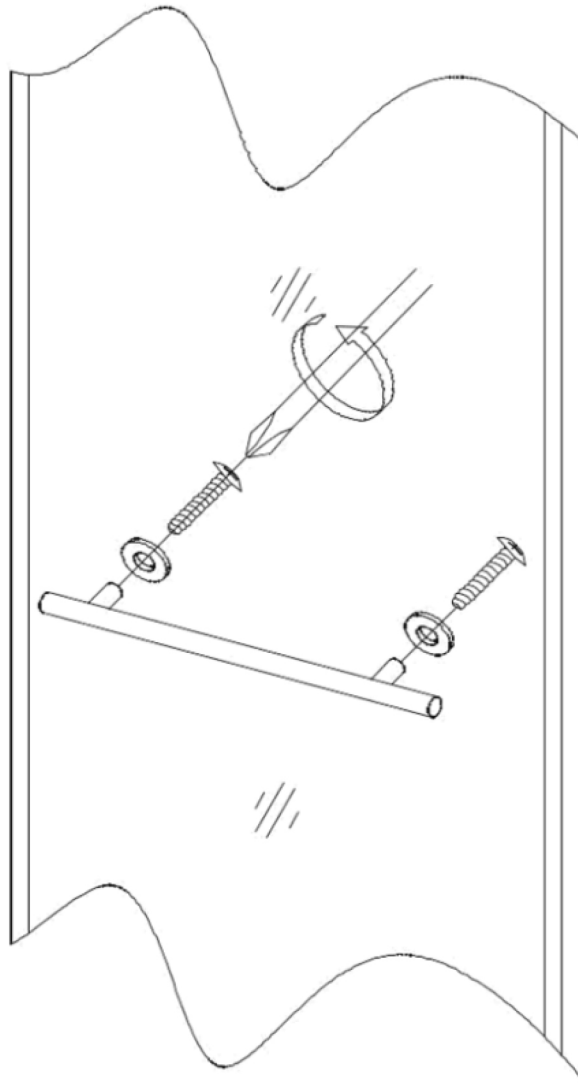
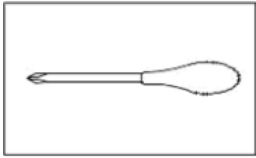



X1

