

Manuale di Montaggio

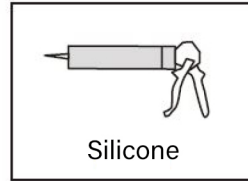

Servizio Clienti
Milano: +39 02 39100160
Roma: +39 06 45443050
www.disegnarecasa.com

Strumenti Richiesti

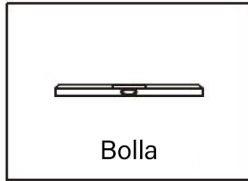
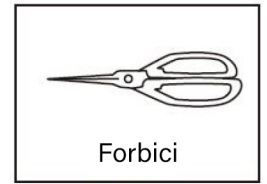
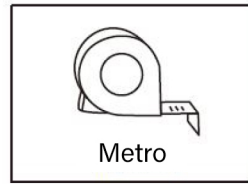
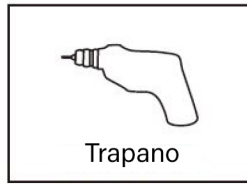
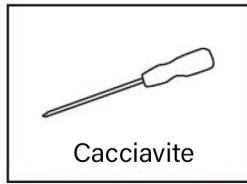
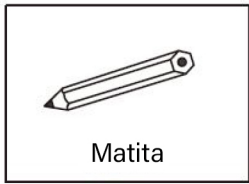

Attenzione

Collegare tutte le viti al vetro, si prega di non utilizzare un trapano avvitatore a batteria, solo a mano

Dotazione di fornitura

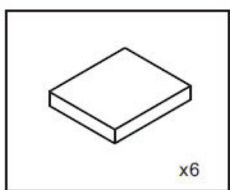
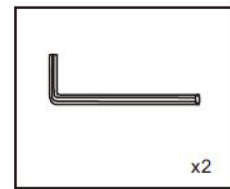
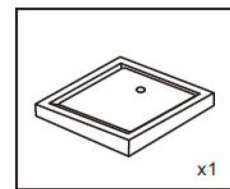
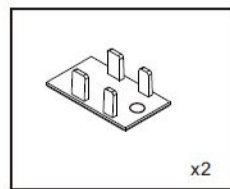
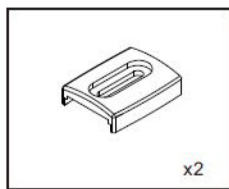
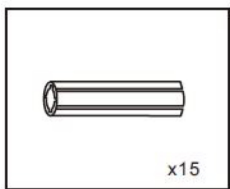
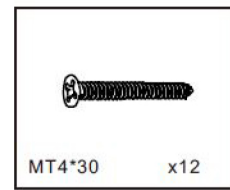
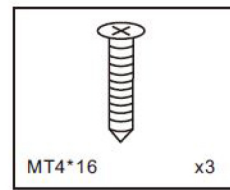
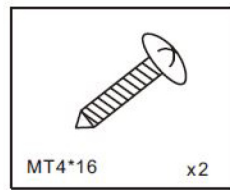
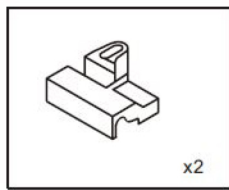
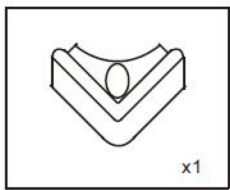
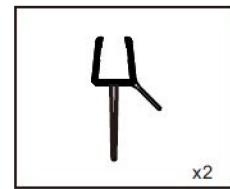
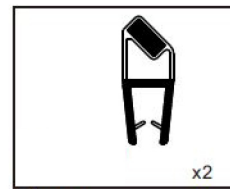
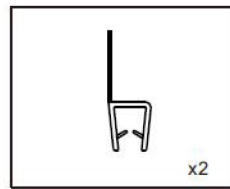
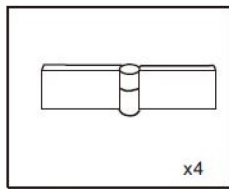
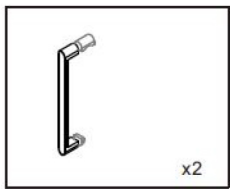
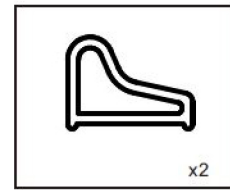
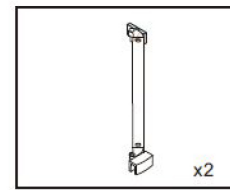
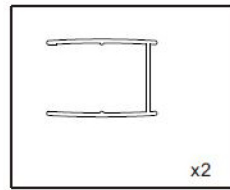
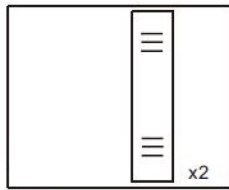
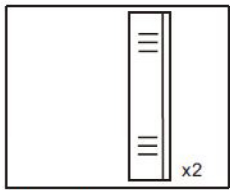

Notare che:

Le frecce sono rivolte verso l'alto e all'esterno.

Può essere utilizzato su entrambi i lati senza frecce.

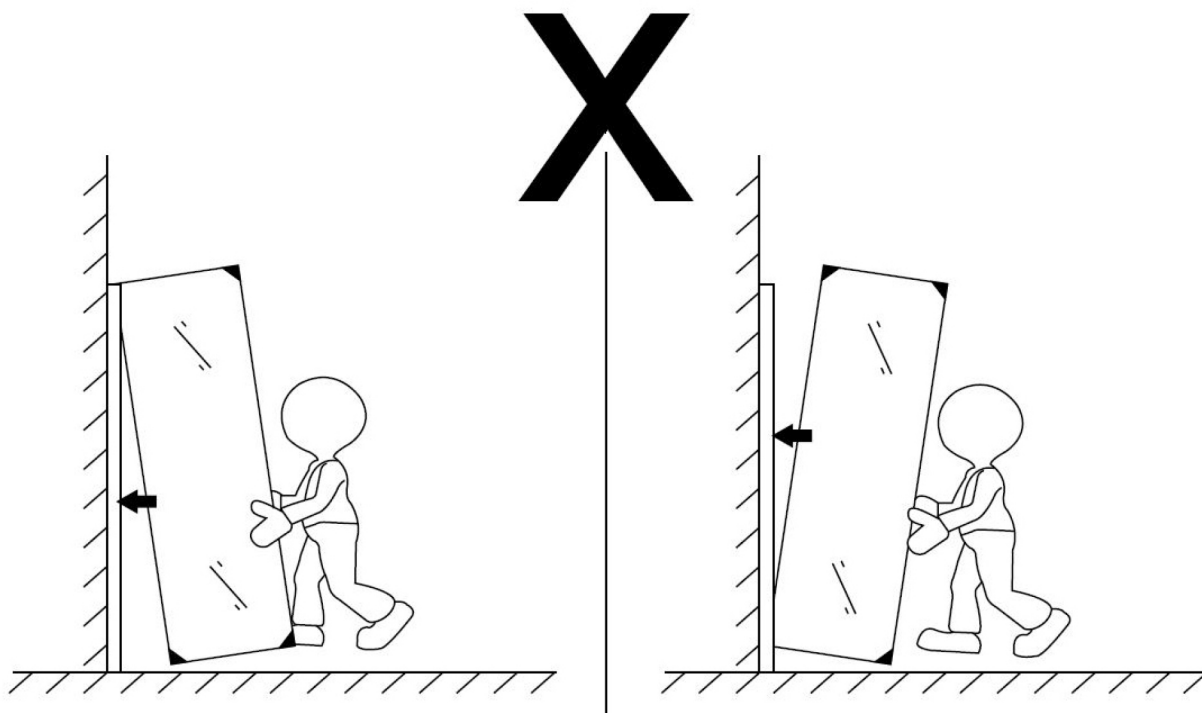
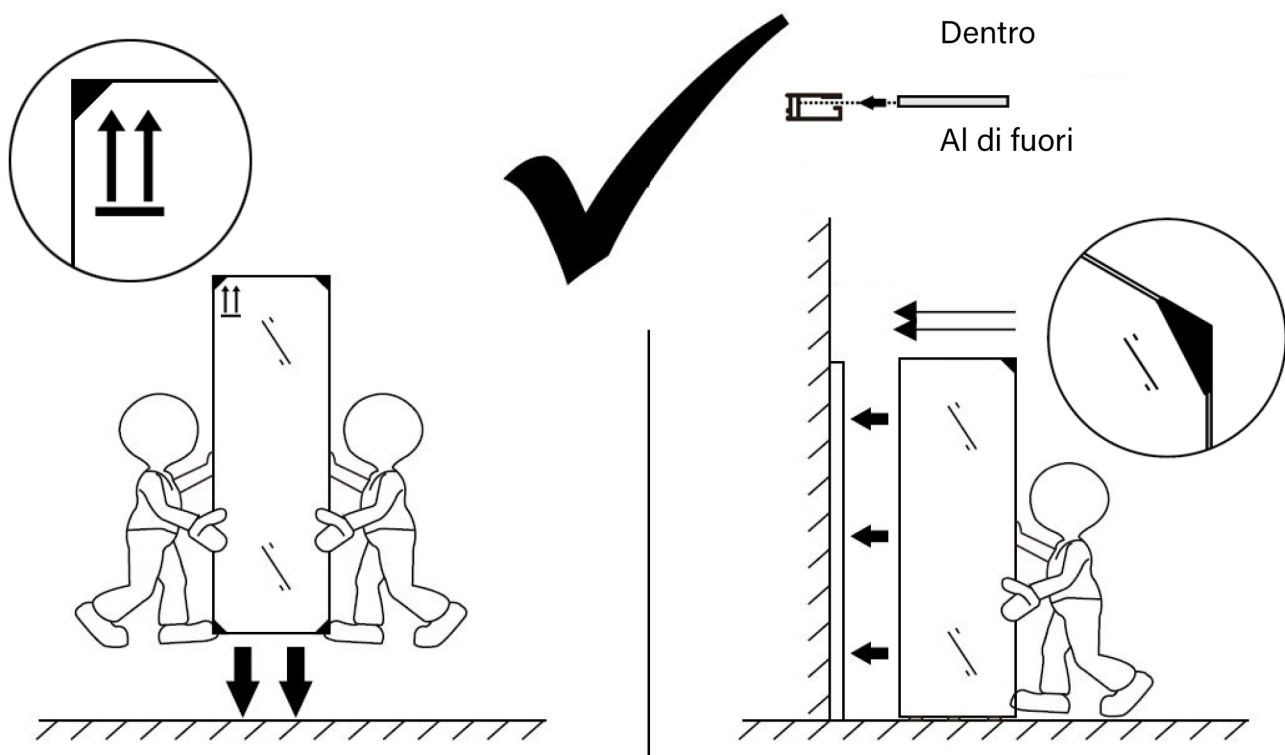

Montaggio

1. Allineare la base della doccia con la livella a bolla d'aria e collegare lo scarico.
2. Allineare anche i profili con una livella a bolla d'aria come mostrato nell'immagine seguente e contrassegnare i fori con una penna.
3. Praticare i fori da 6mm sul muro.
4. Usa tasselli per spostare i profili. Si prega di utilizzare solo tasselli adatti alle pareti.

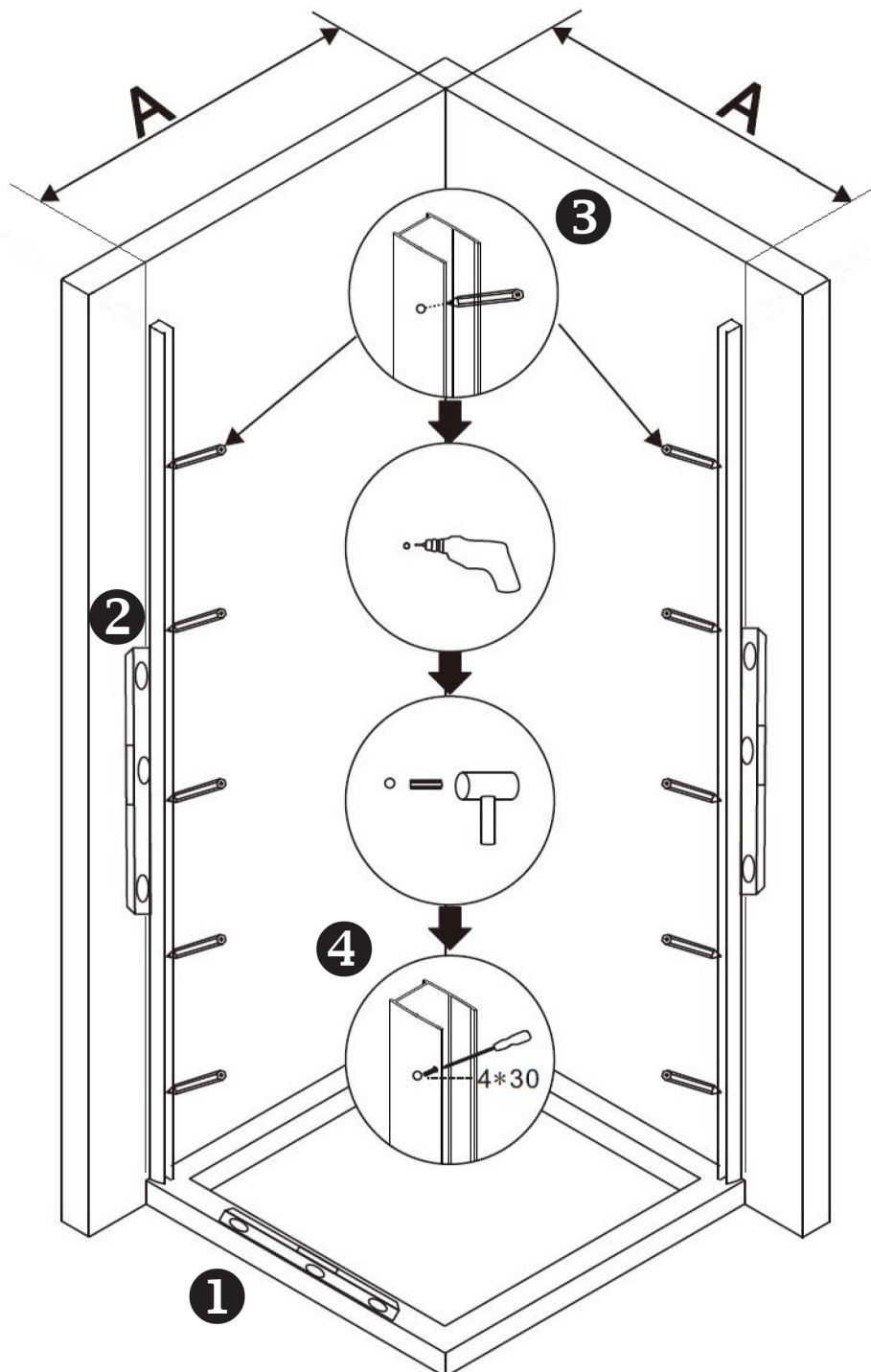

1. Posizionare il piccolo tampone di gomma tra il vetro e il piatto della doccia.
2. Ora spingere gli elementi di vetro fissi nei profili di alluminio.

Importante: l'interno dell'elemento in vetro è nano-rivestito e l'esterno è contrassegnato.



1. Spostare le cerniere portanti per le porte di vetro con gli elementi di vetro fissi.
Come mostrato nella nostra illustrazione, i perni di articolazione vengono visualizzati per tutta la notte.

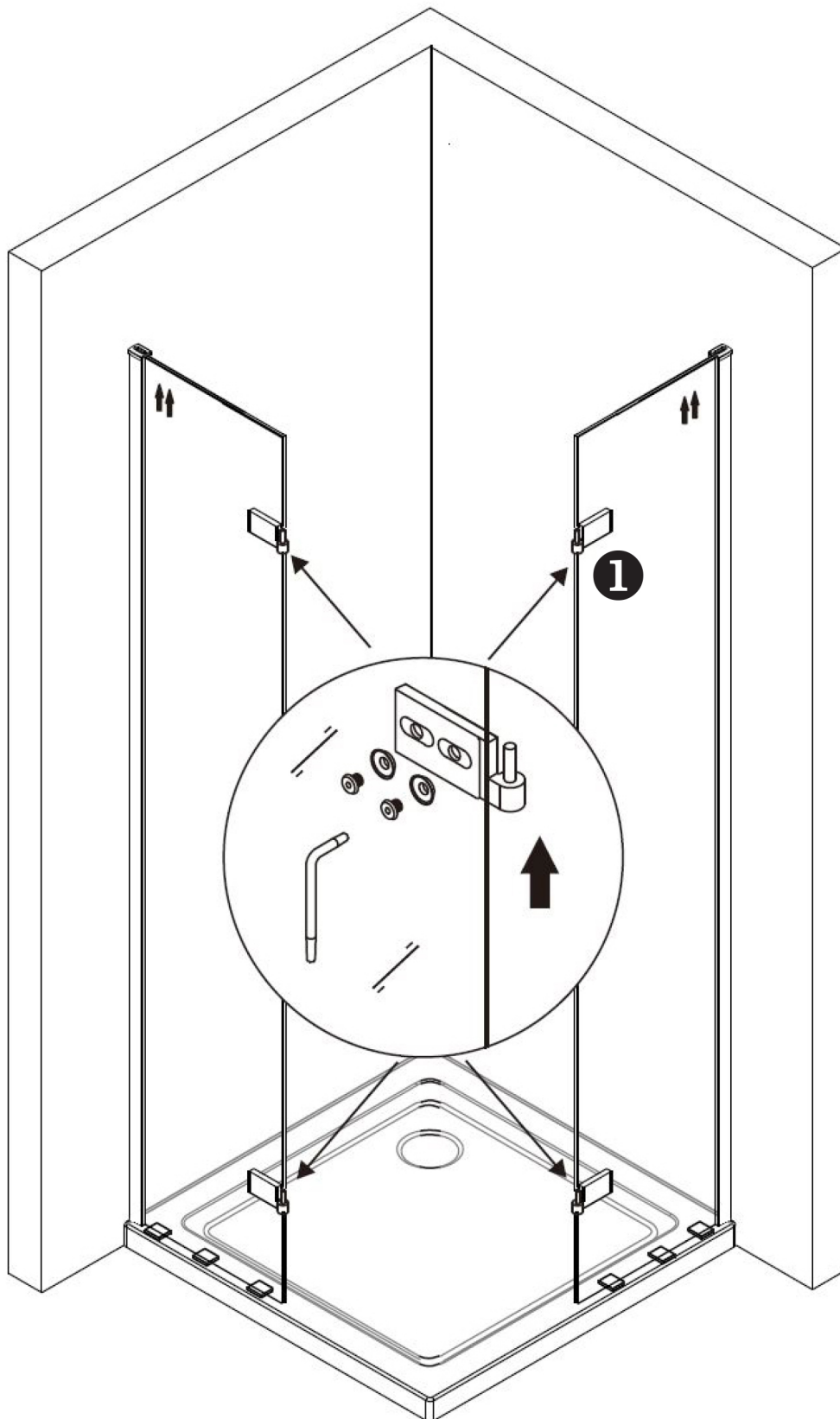

1. Ora avvita i cardini alle porte di vetro.
2. Montare le guarnizioni magnetiche.

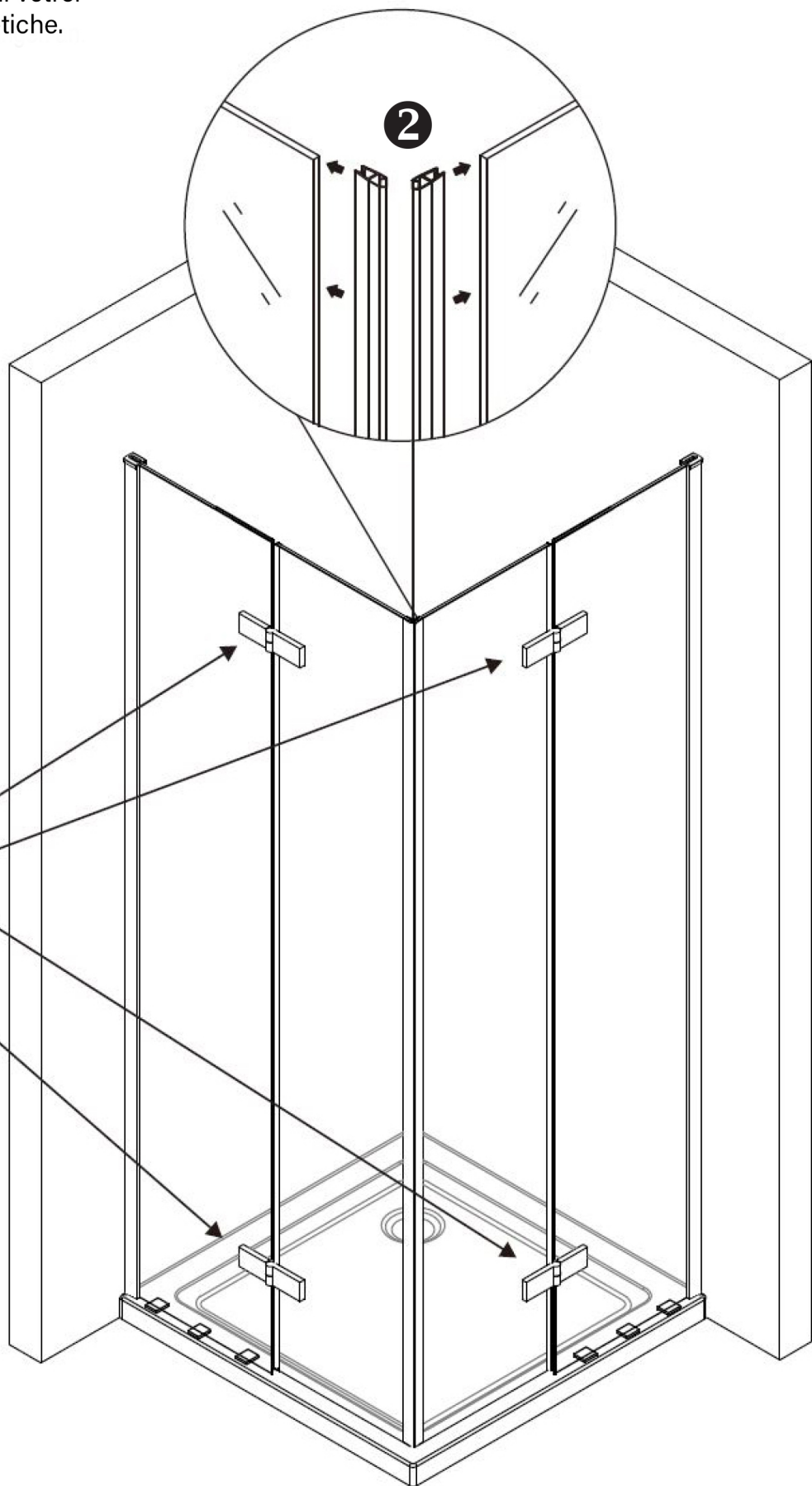
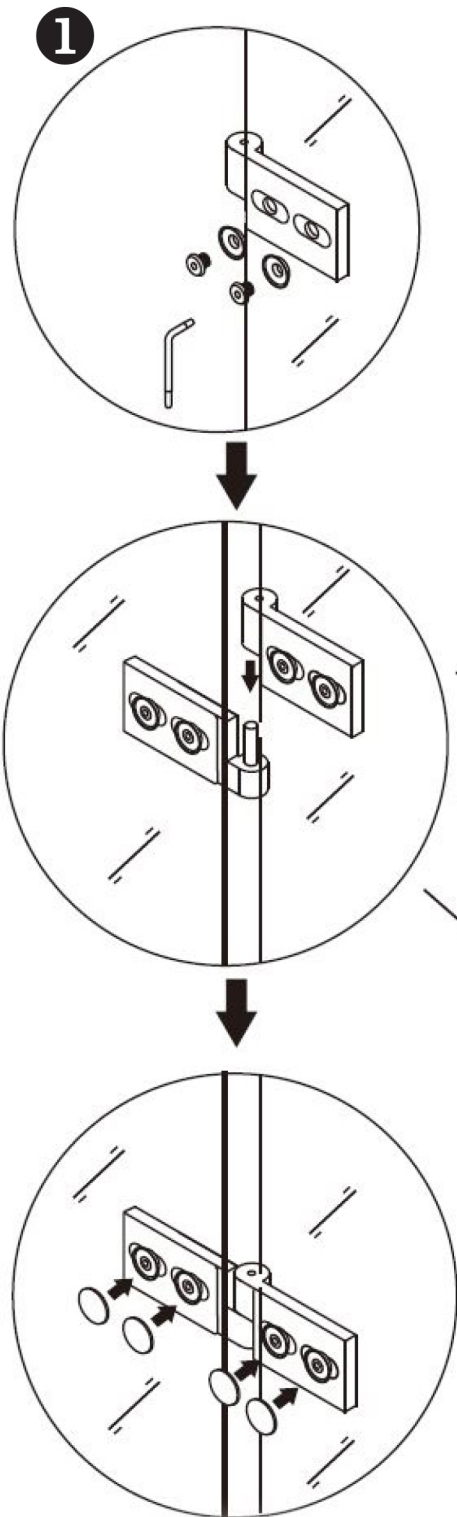

1. Allineando gli elementi in vetro nei profili terminali, è possibile ottenere un movimento regolare delle porte e della serratura magnetica.
2. Posizionare la piastra di fissaggio e il cappuccio sul profilo e avvitarli.
3. Installare le strisce di protezione sotto gli sportelli di vetro.

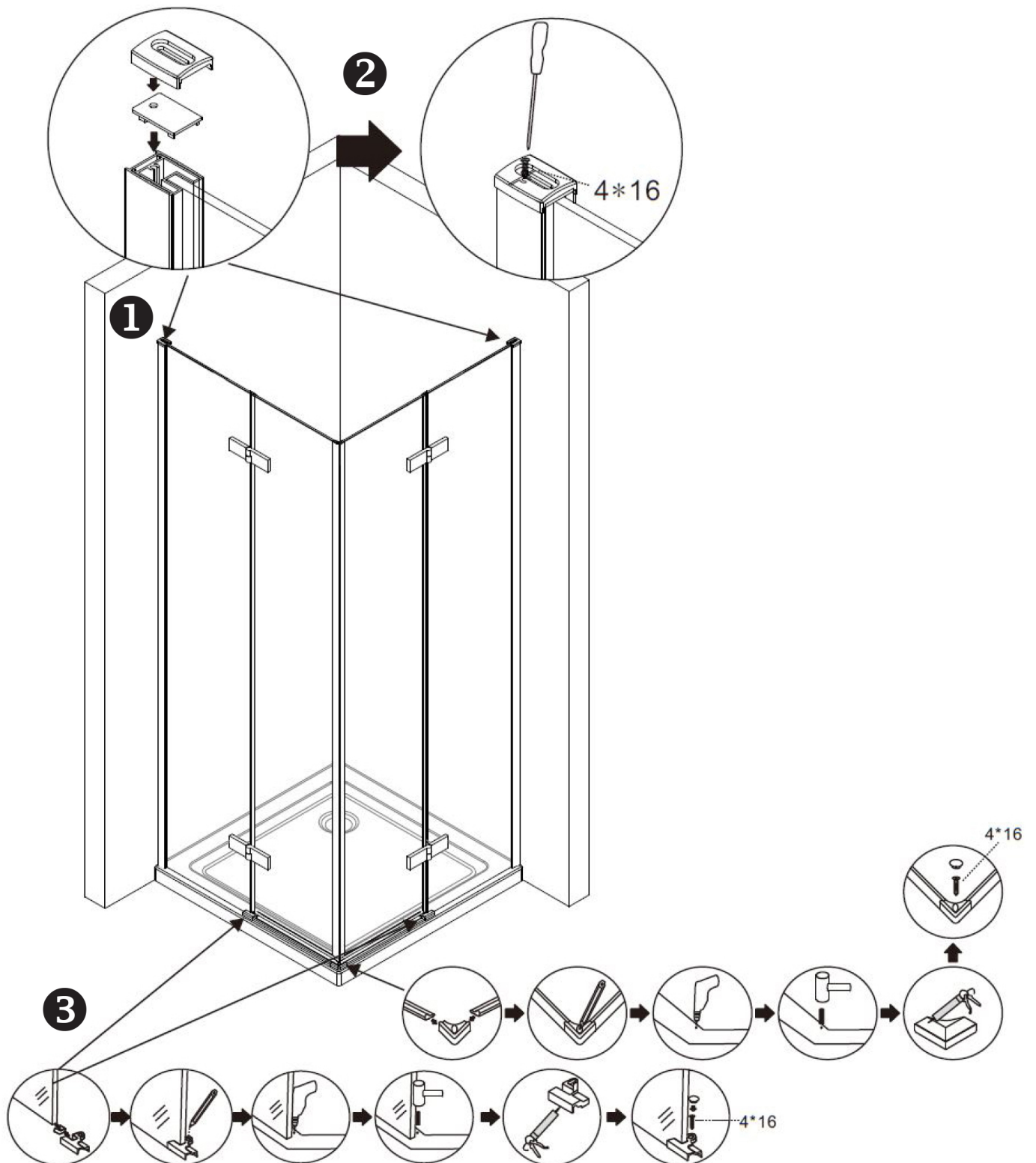

1. Installare gli stabilizzatori tra gli elementi di vetro fissi e la parete.

2. Posizionare le guarnizioni sulle porte di vetro.

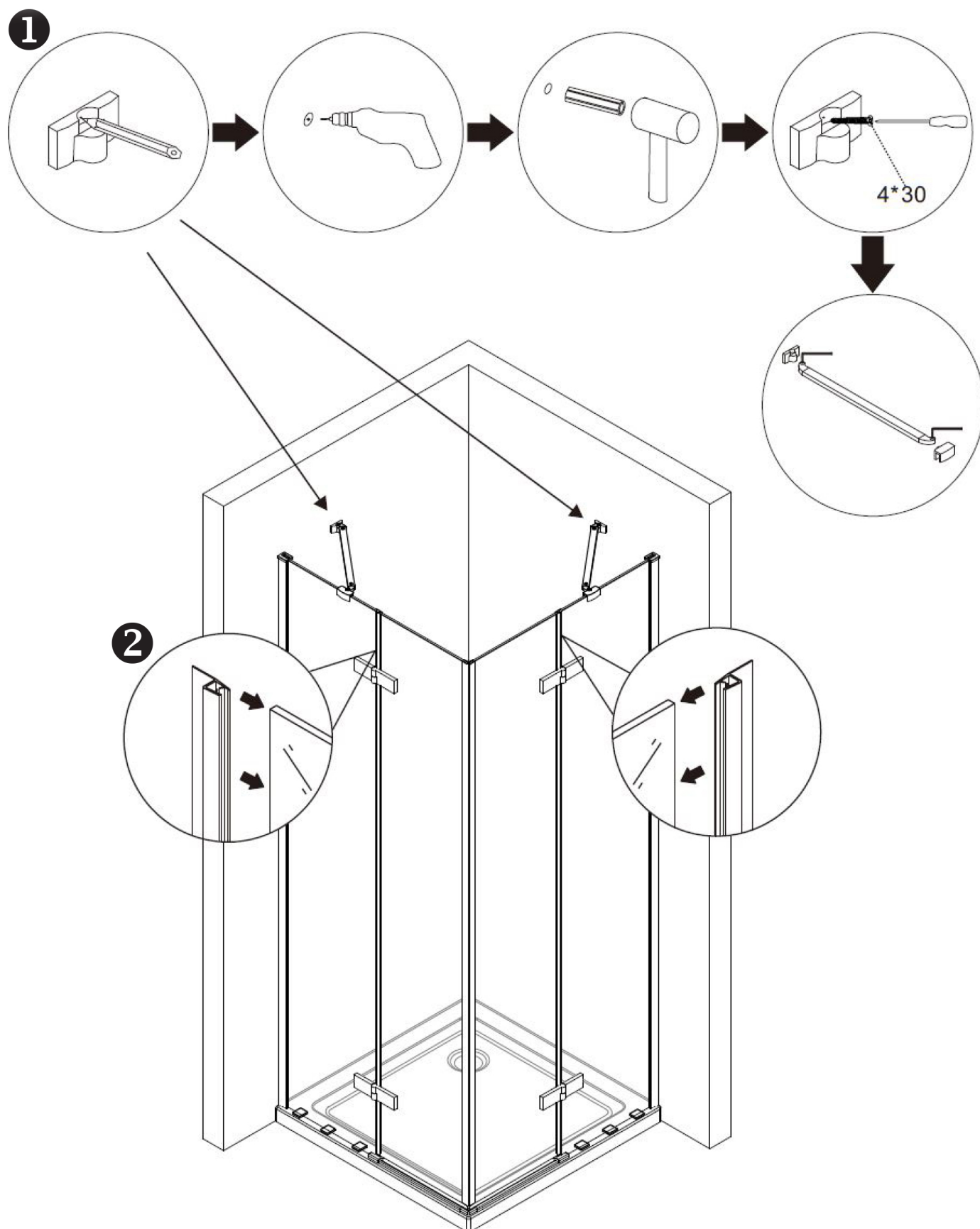

1. Ora avvitare insieme le due maniglie delle porte.

2. Metti i sigilli delle porte sul fondo delle porte di vetro.

3. Tirare i giunti in silicone lungo i profili in alluminio e gli elementi di vetro fissi come mostrato nella figura sotto.

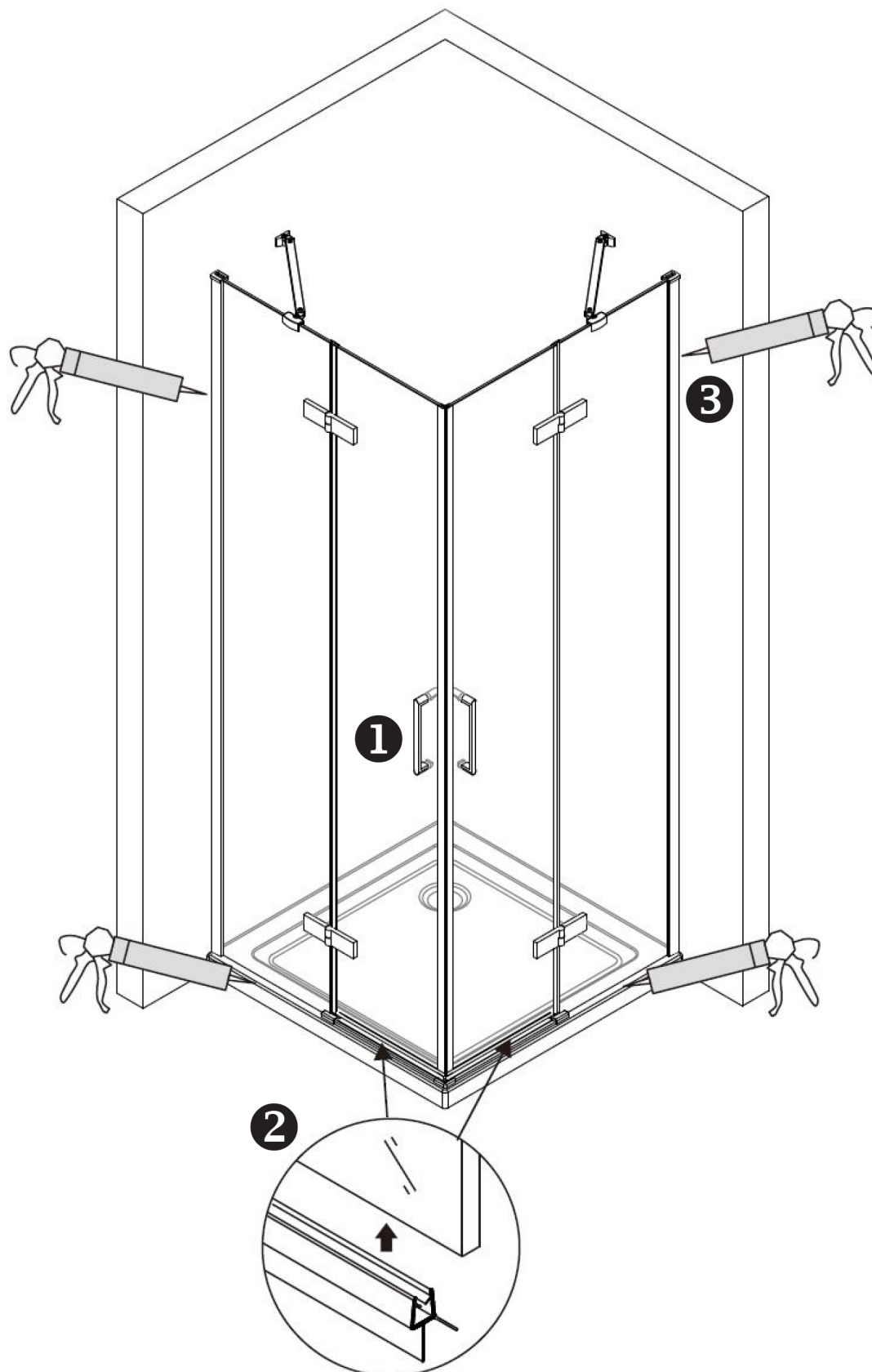

Disegnare casa



IT DICHIARAZIONE

Il seguente manuale è solo una guida standard. Nel caso in cui dovessero essere presenti errori, dovuti a eventuali modifiche postume del prodotto, si prega di considerare il manuale unicamente come riferimento per il montaggio. L'azienda si riserva il diritto di modifica.