

## STRUMENTI NECESSARI

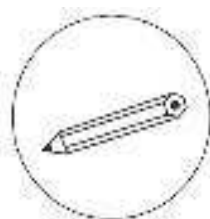

MATITA

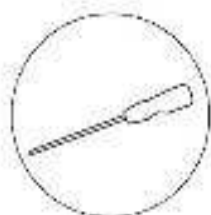

CACCIAVITE A CROCE

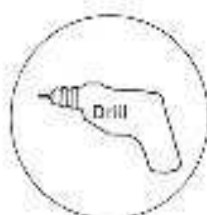

TRAPANO

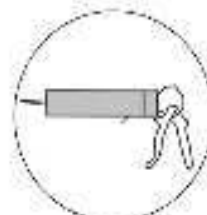

SILICONE

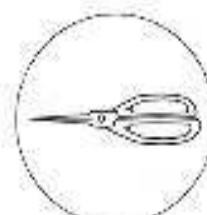

FORBICI



LIVELLA

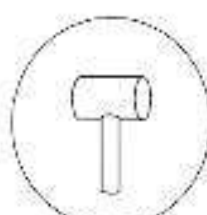

MARTELLETTO DI GOMMA







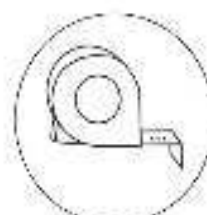





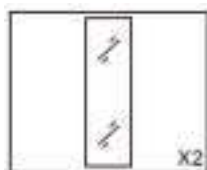
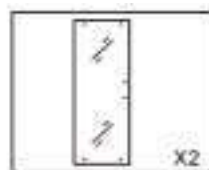

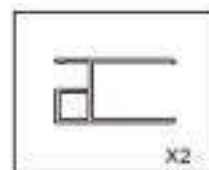
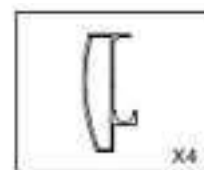

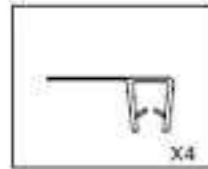

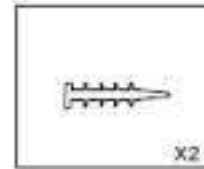
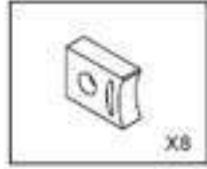
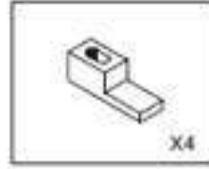
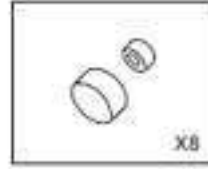
CHIAVE ESAGONALE

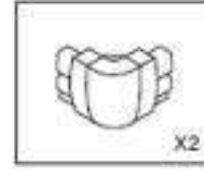
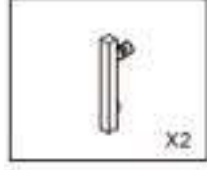
(CONTENUTO DELLA CONSEGNA)



METRO

## CONTENUTO DELLA CONSEGNA

 X2	 X2	 X2	 X2	 X4
 X4	 X4	 X4	 X2	 X2
 X8	 X4	 X8	 X2	 X2
 X2	 4*30 X16	 4*16 X4	 4*12 X12	 X8
 X1	 X1	 4*12 X4	 X1	

## OSSERVAZIONI

Tute le viti connesse al vetro devono essere fissate manualmente e non tramite avvitatore automatico!

Il profilo dovrà essere posizionato a 15 mm dal bordo esterno del piatto doccia, oppure per il valore della traiettoria A secondo il disegno.

## IMPORTANTE

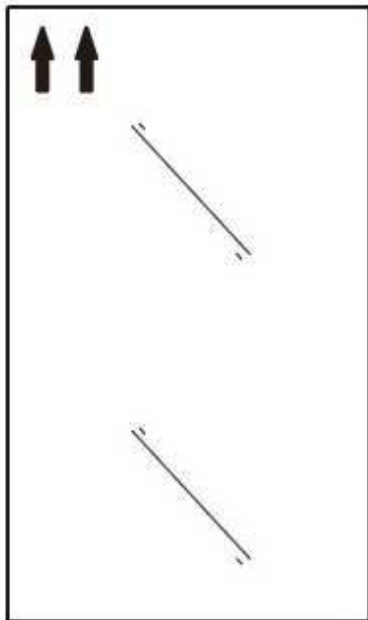

La freccia punta verso l'alto

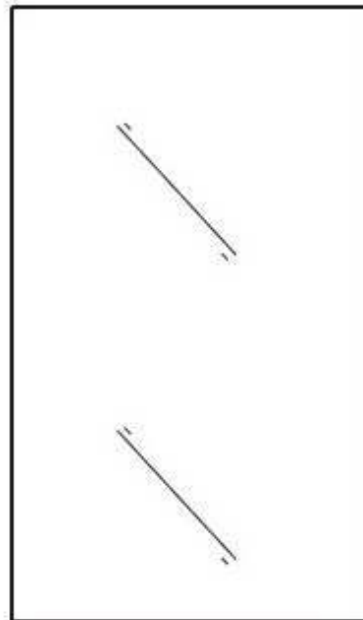

Nessuna freccia = Utilizzabile da entrambi i lati

**Alcune delle nostre cabine doccia sono reversibili, in questo caso non sarà applicata alcuna etichetta al vetro.**

### MONTAGGIO:

Appoggiare i profili alla parete, come indicato nell'immagine e segnare i punti in cui trapanare con l'aiuto di una matita e di una livella.

Eeguire i fori e fissare i profili. Si prega di utilizzare unicamente dei tasselli compatibili con il proprio muro.

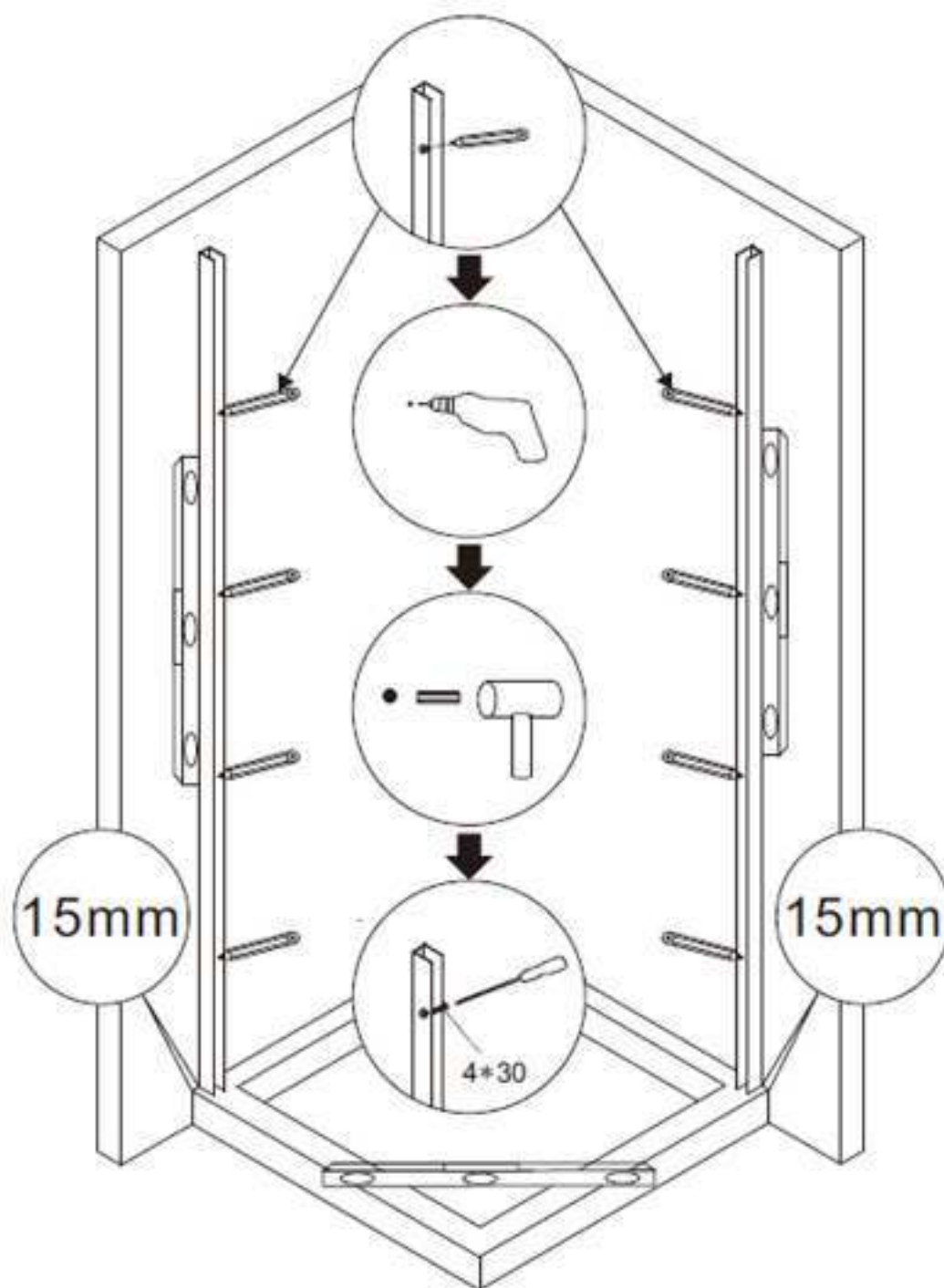

Utilizzare le viti 4x30 per fissare le guide di alluminio in alto e in basso. (come nell'immagine)

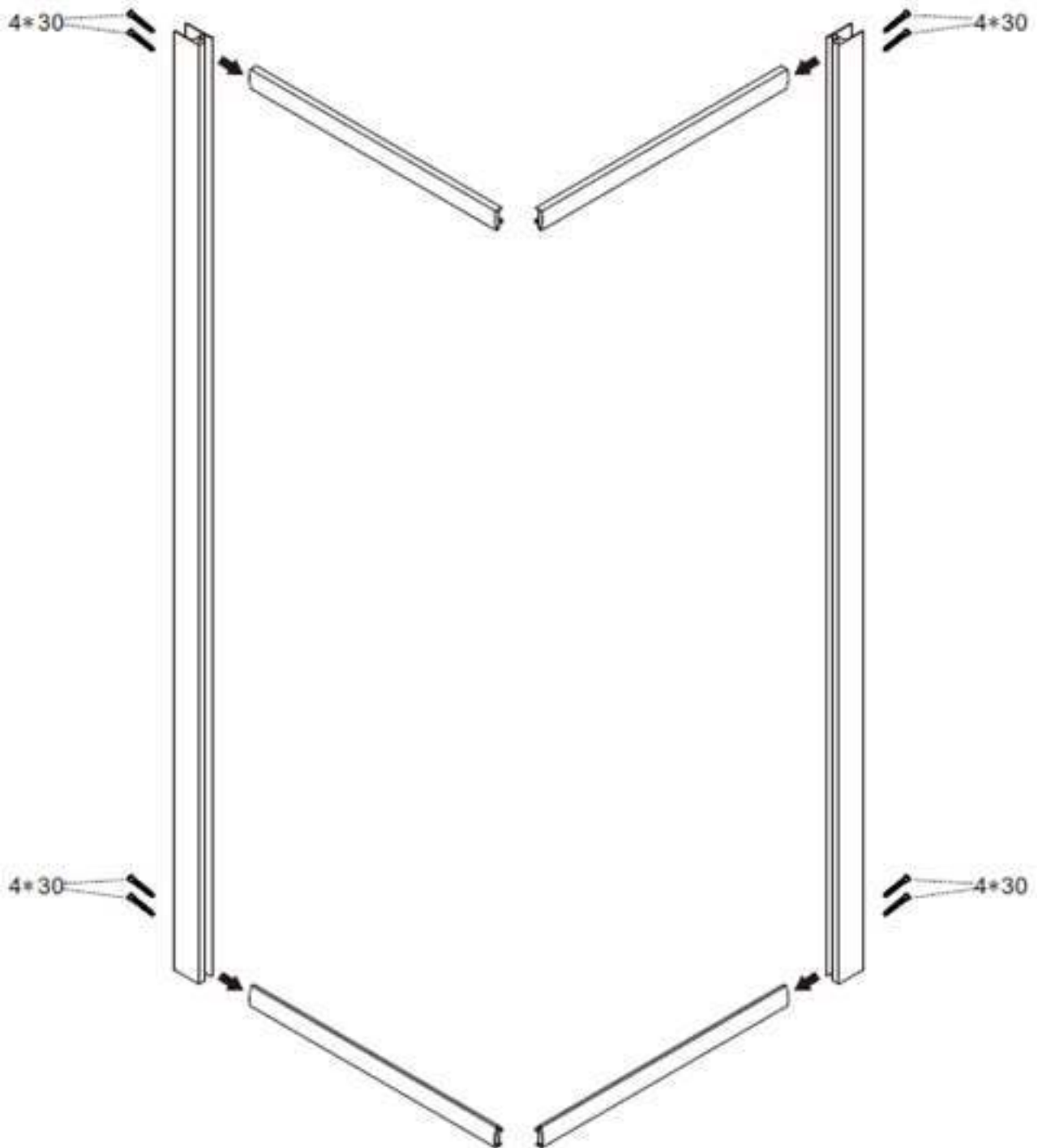

## Box doccia EX506

Inserire gli elementi in vetro all'interno delle guide d'alluminio.

Si presti attenzione a infilare il vetro all'interno del profilo murale e solo successivamente procedere all'inserimento della guarnizione, facendola scorrere dall'alto verso il basso.

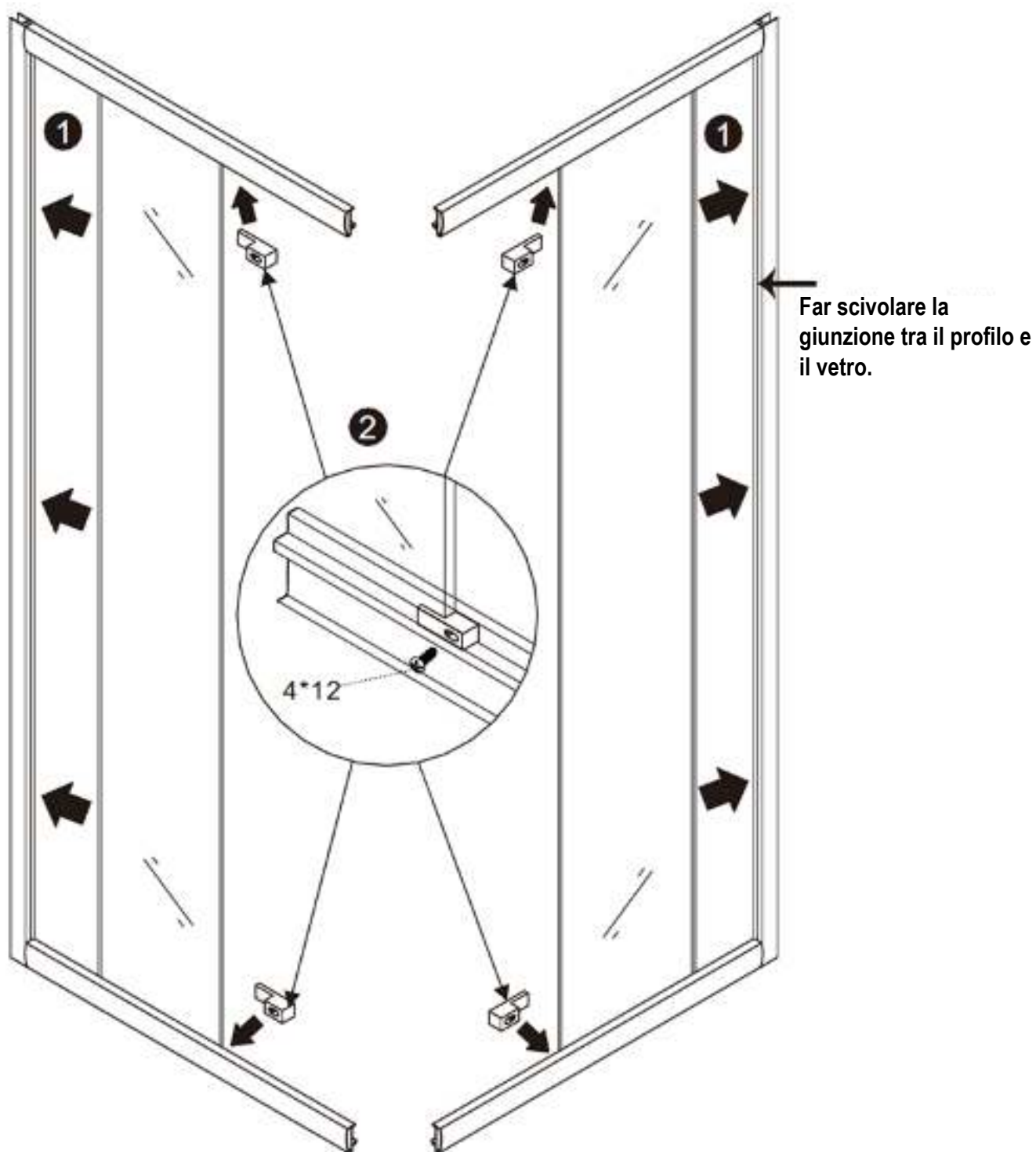

Inserire le cornici così formate all'interno del profilo murale (Come illustrato)

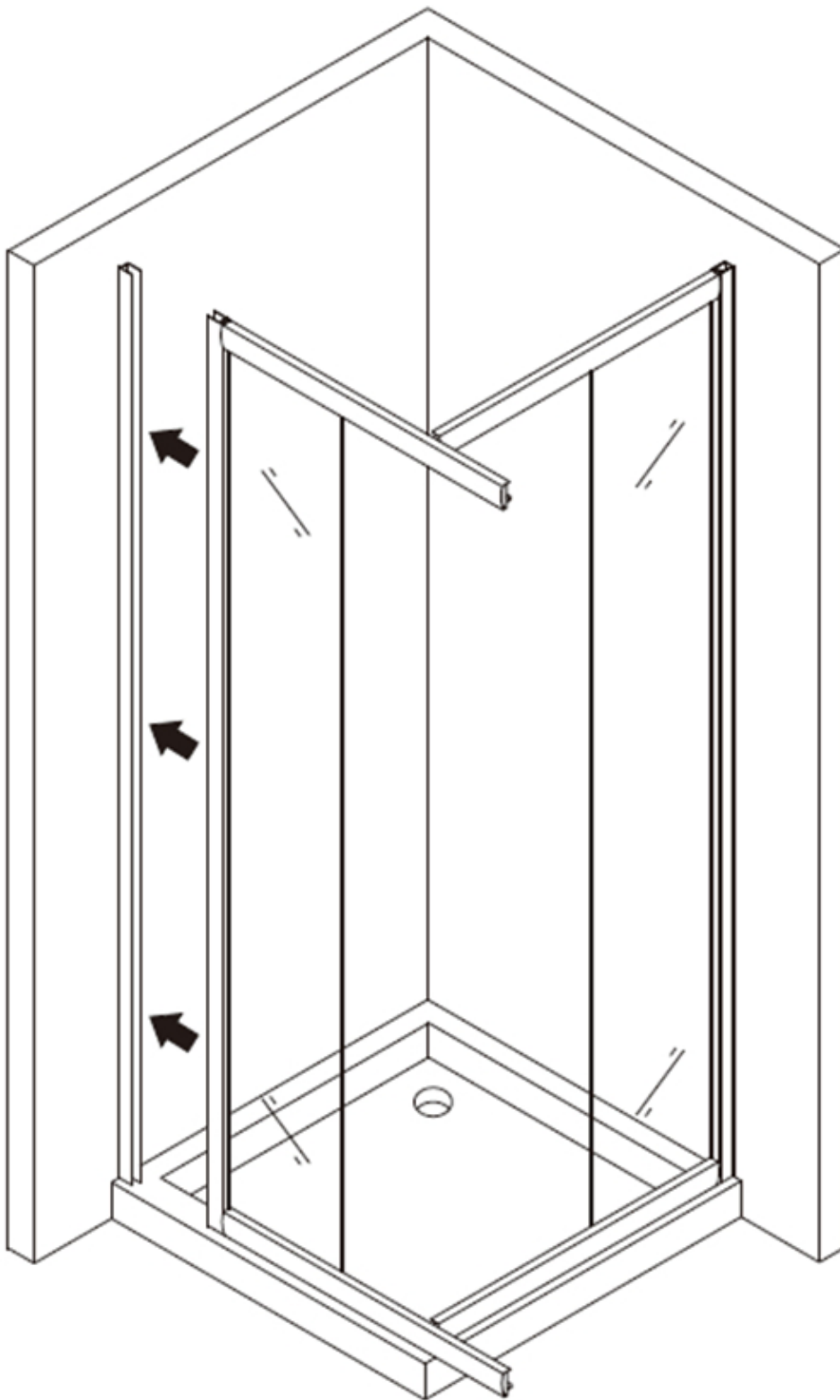

## Box doccia EX506

Collegare i due elementi tramite i supporti di plastica. (Come indicato di seguito)

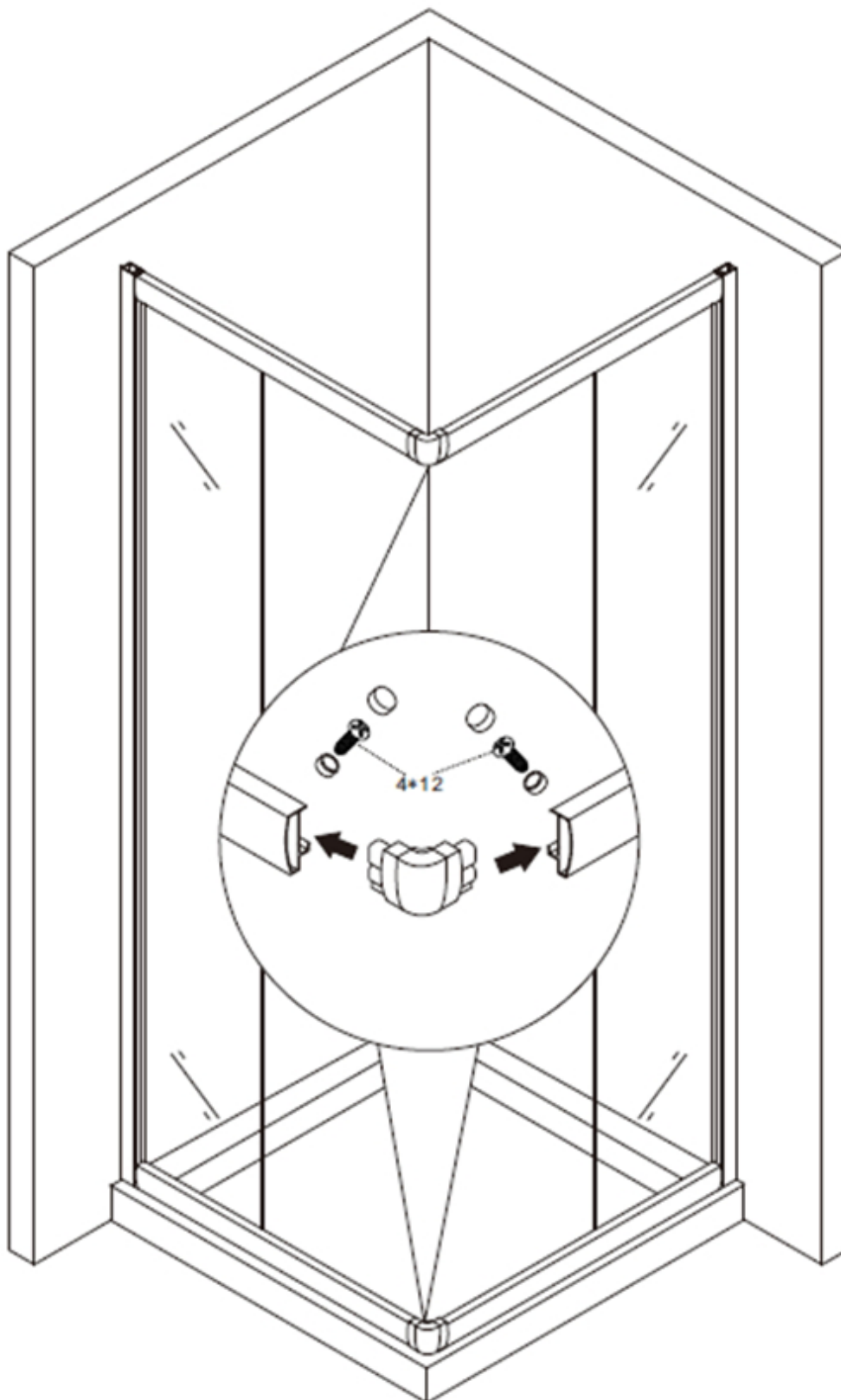



Installare le rotelle di scorrimento, rispettivamente in basso le rotelle con bottone e in alto quelle sprovviste di bottone.

Importante: Le rotelle di scorrimento superiori sono regolabili. Se non dovessero scorrere uniformemente sul vetro potranno essere regolate con la chiave esagonale corrispondente.

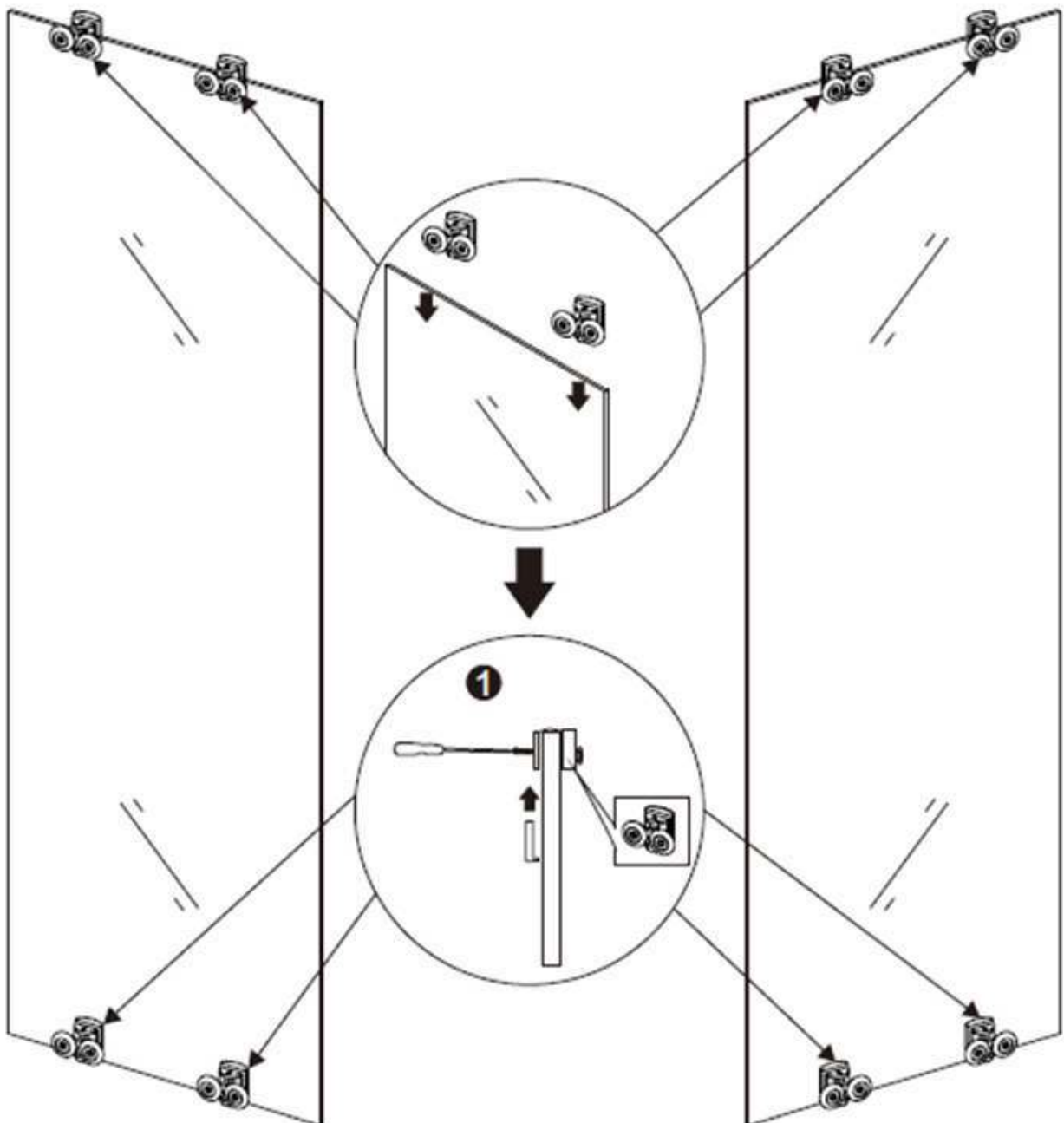

## Box doccia EX506

Disporre la porta sulla guida di alluminio.

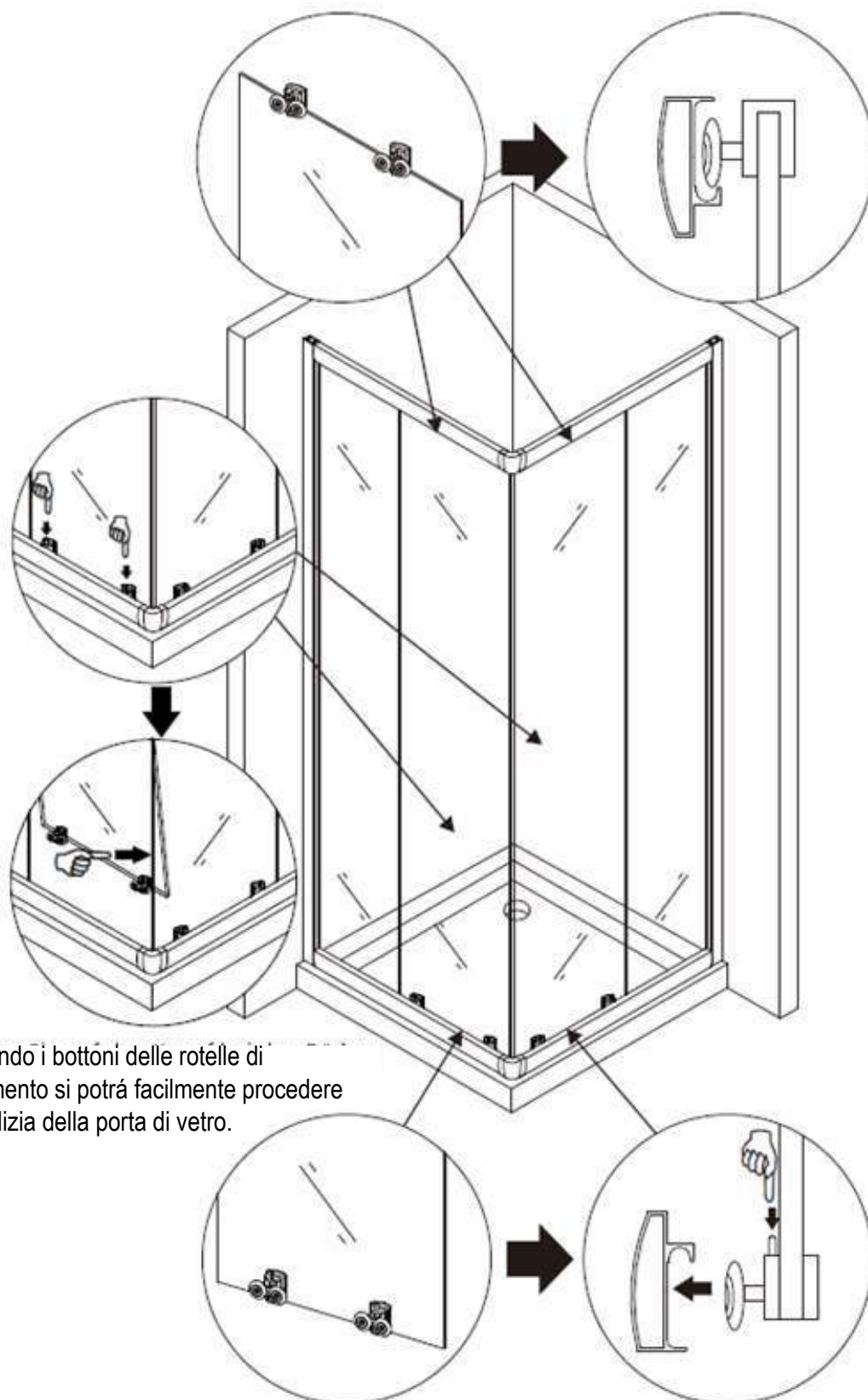

Premendo i bottoni delle rotelle di scorrimento si potrà facilmente procedere alla pulizia della porta di vetro.

1. Fissare i giunti magnetici alla porta
2. Installare i giunti tra la porta e il profilo di alluminio
3. Eseguire i fori nel profilo e connettere il segmento di vetro al profilo murale, utilizzando le viti 4x16
4. Porre la protezione sulla vite.

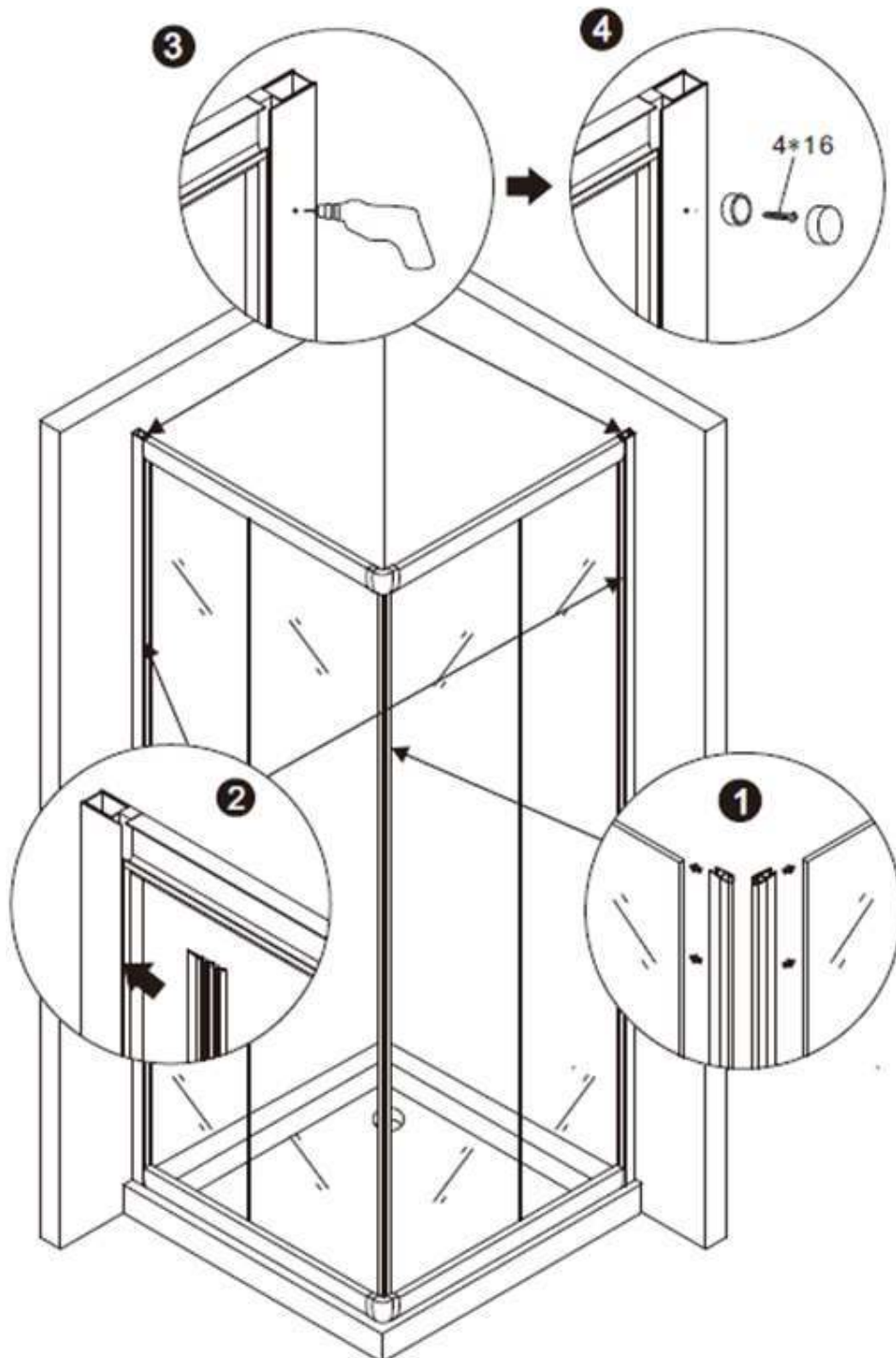

## Box doccia EX506

1. Fissare il blocco ruote alla guida di alluminio
2. Montare la maniglia della porta
3. Installare le guarnizioni di impermeabilità al vetro fisso e alla porta
4. Porre il coperchio protettivo sul profilo di alluminio
5. Sigillare il perimetro esterno della cabina doccia con del silicone

