

8004A

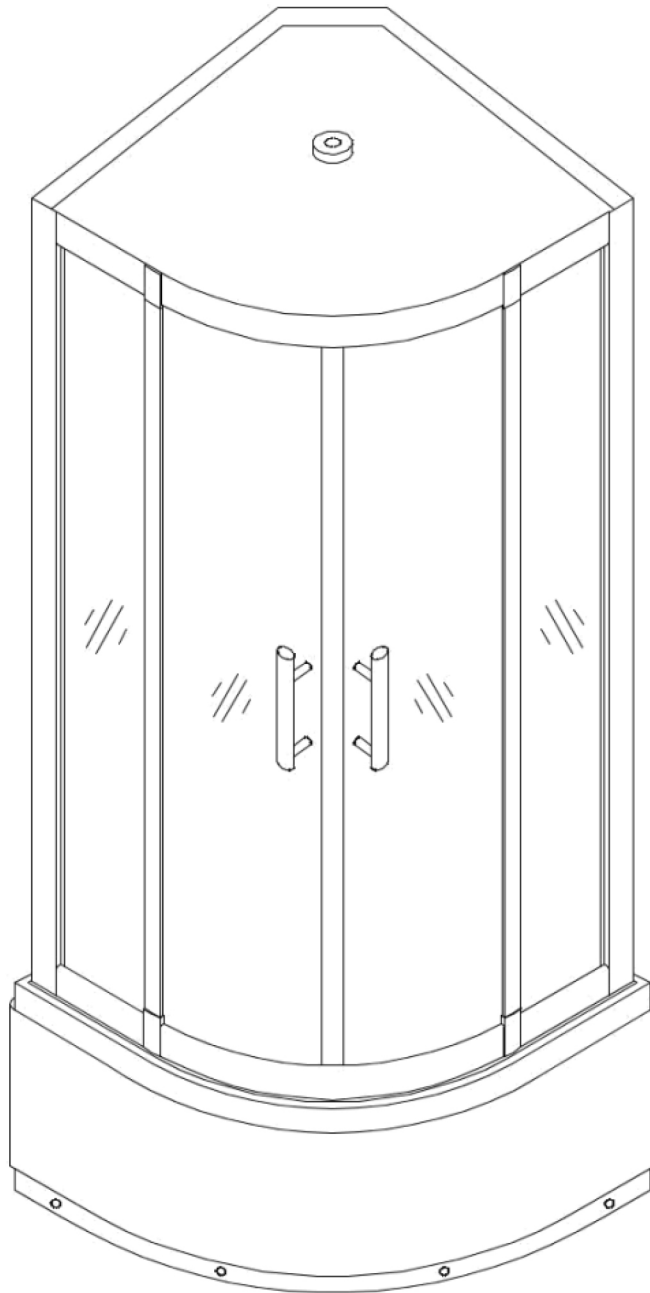

1/4

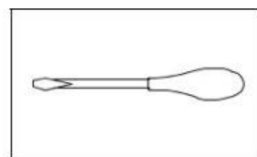
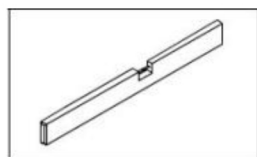
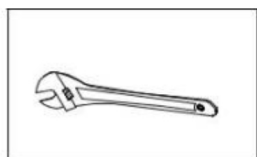
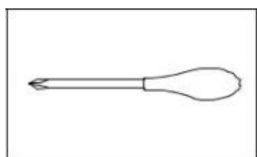
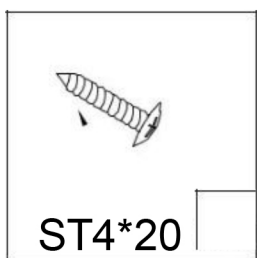
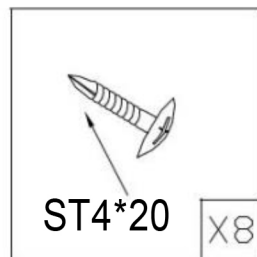
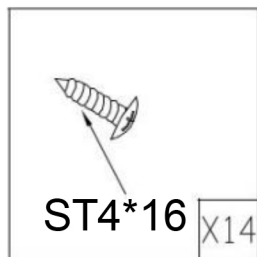
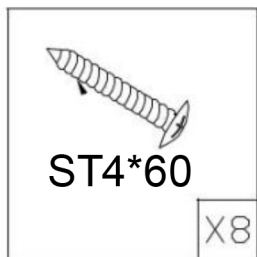
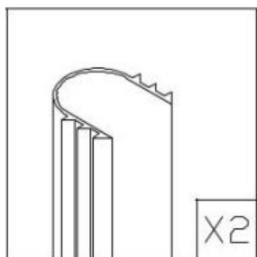
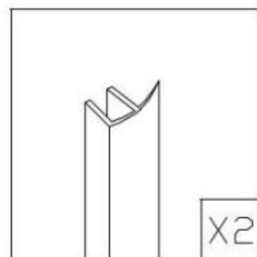
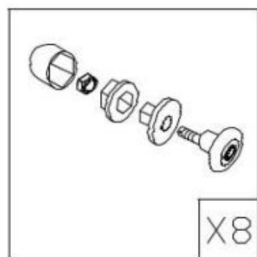
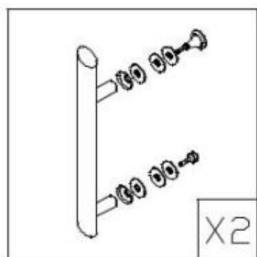
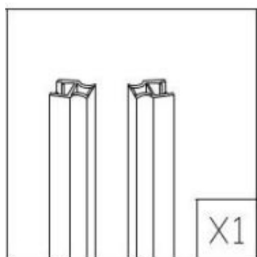
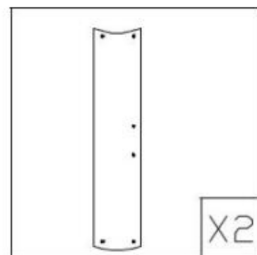
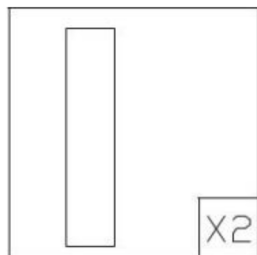
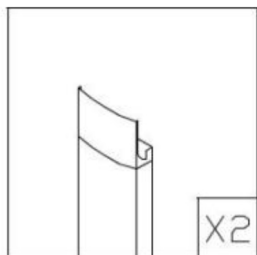
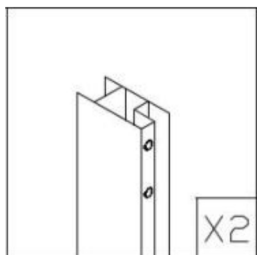
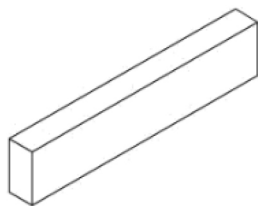

2/4

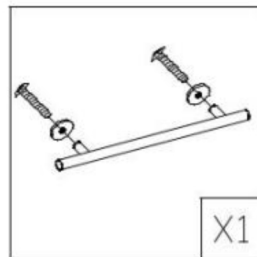
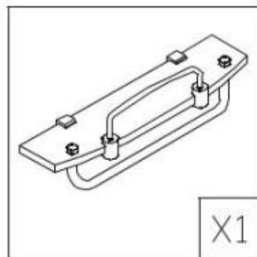
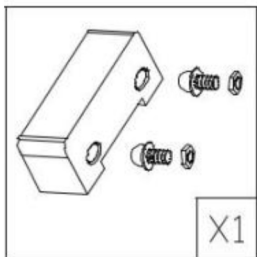
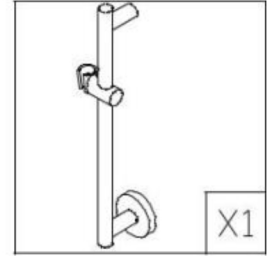
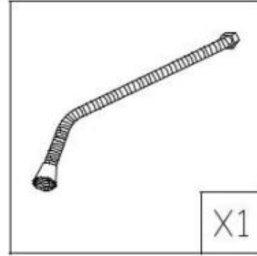
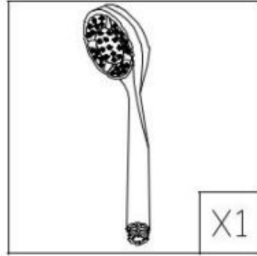
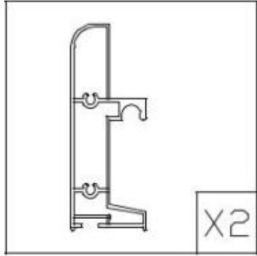
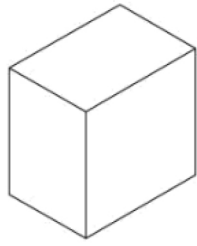

3/4

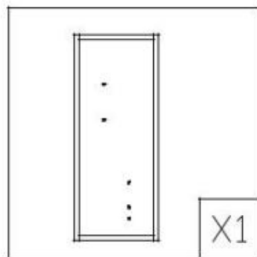
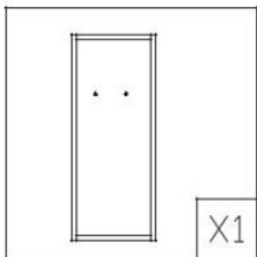
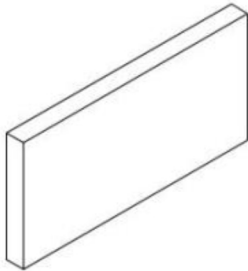

4/4

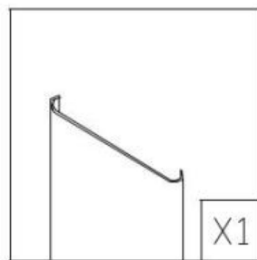
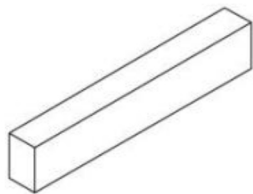

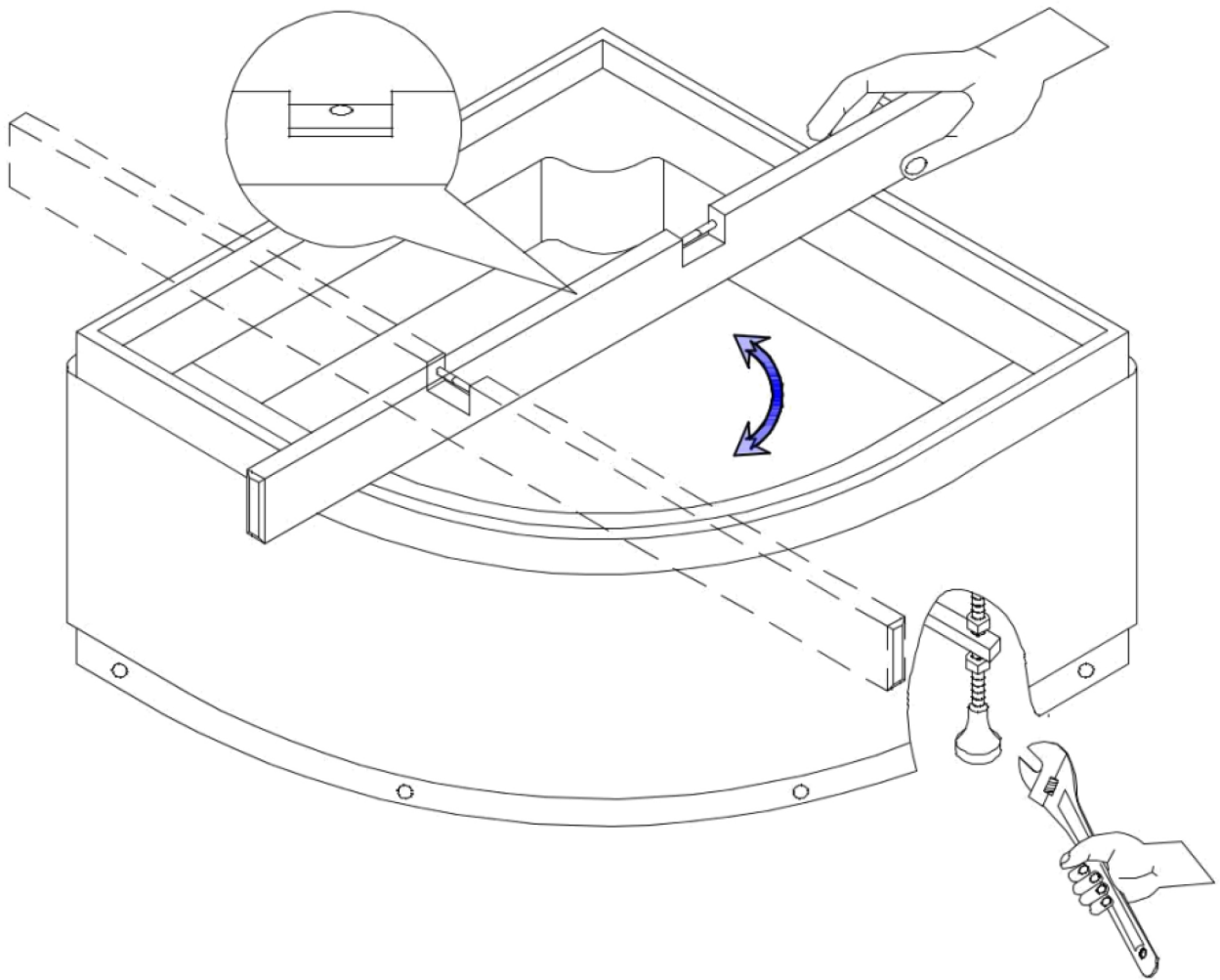
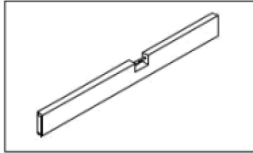
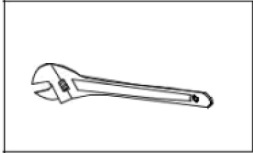

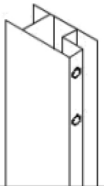

X2

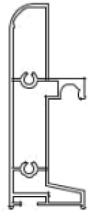

X2

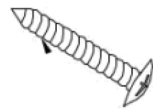

ST4\*60

X8

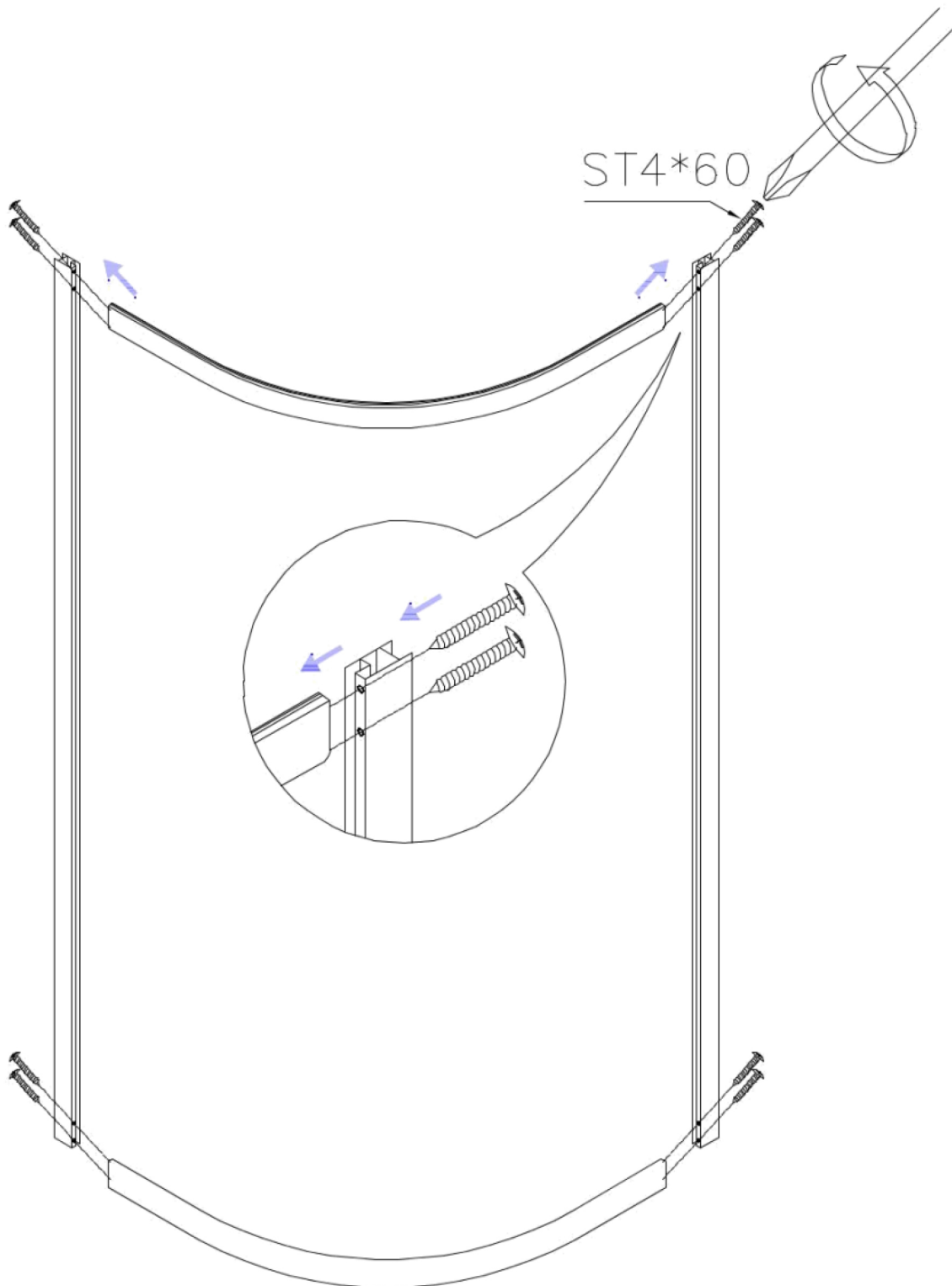
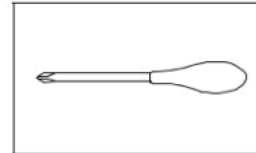

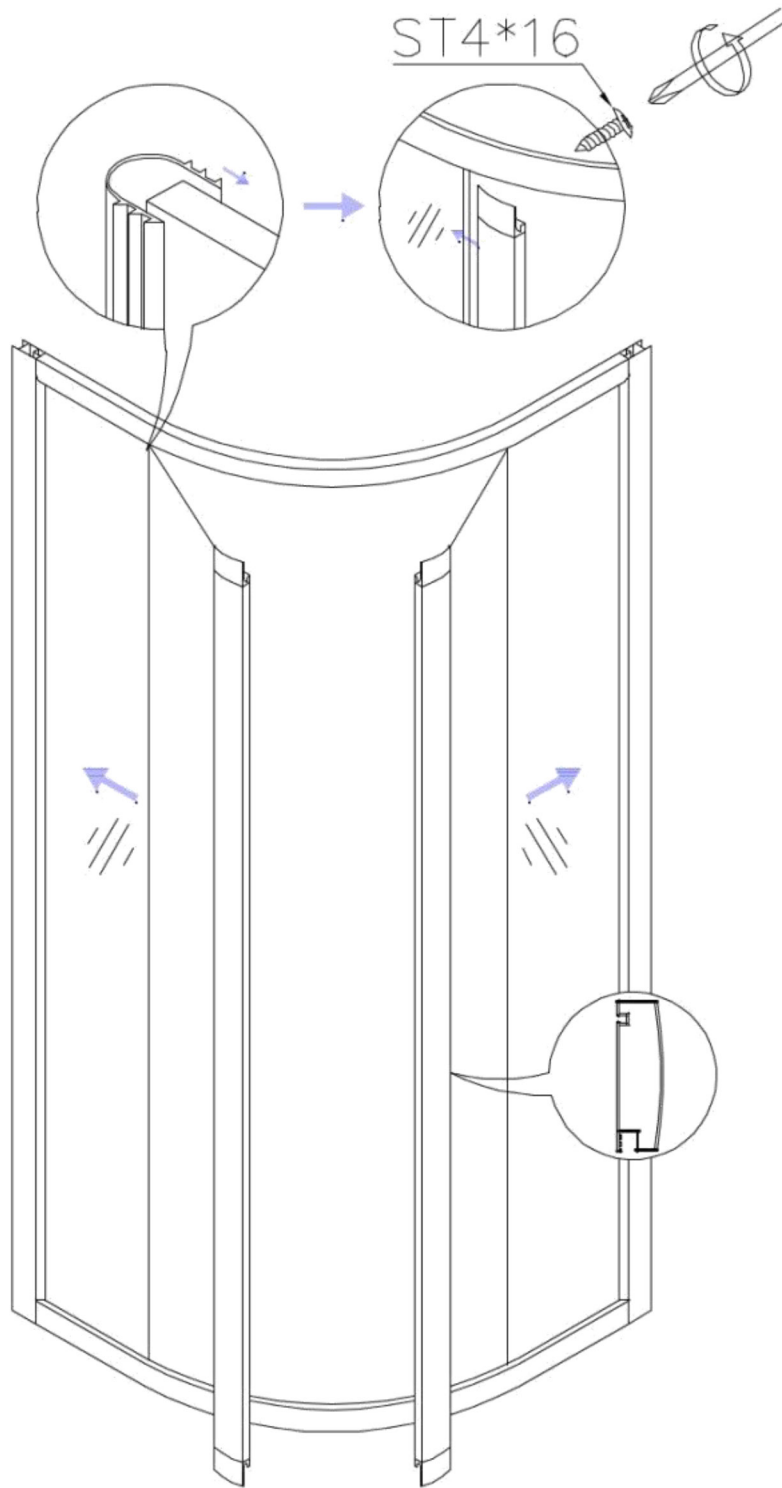
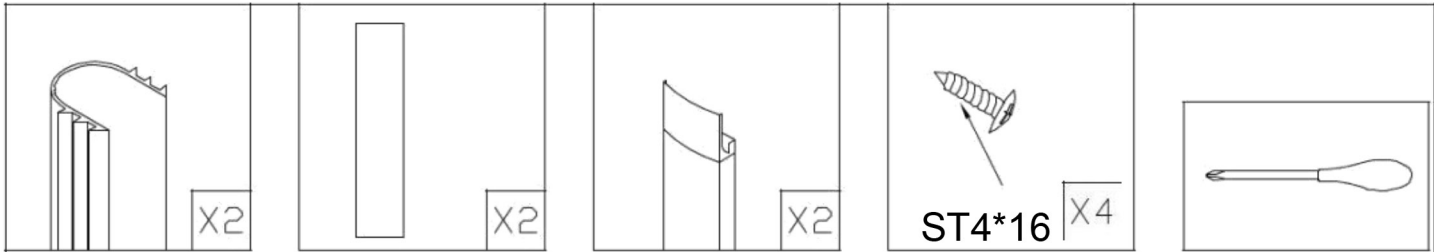

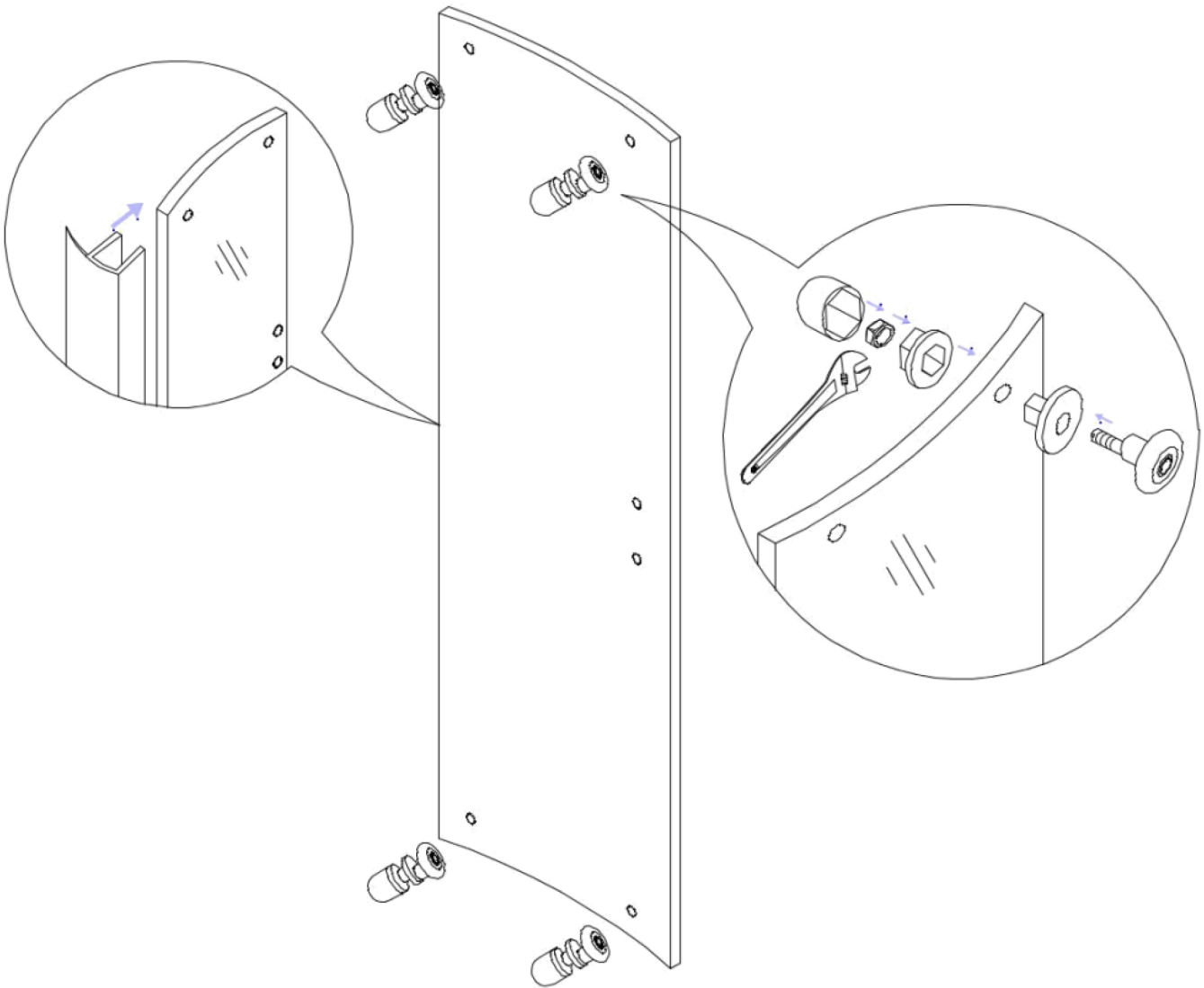

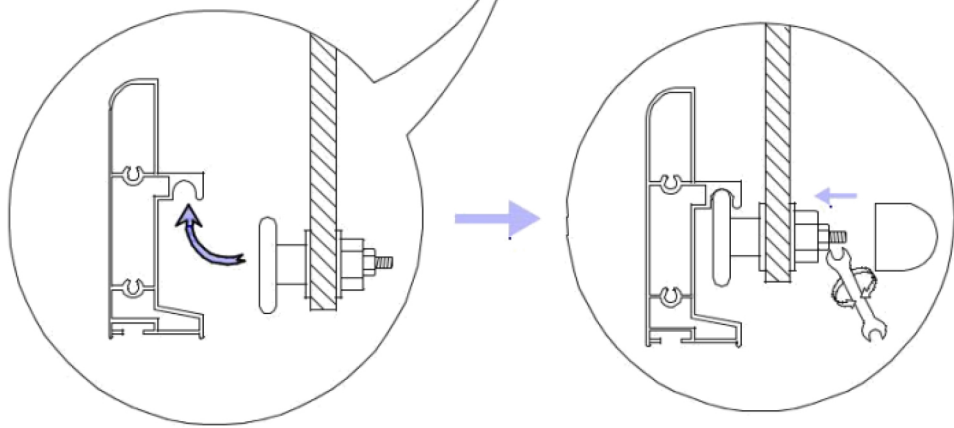
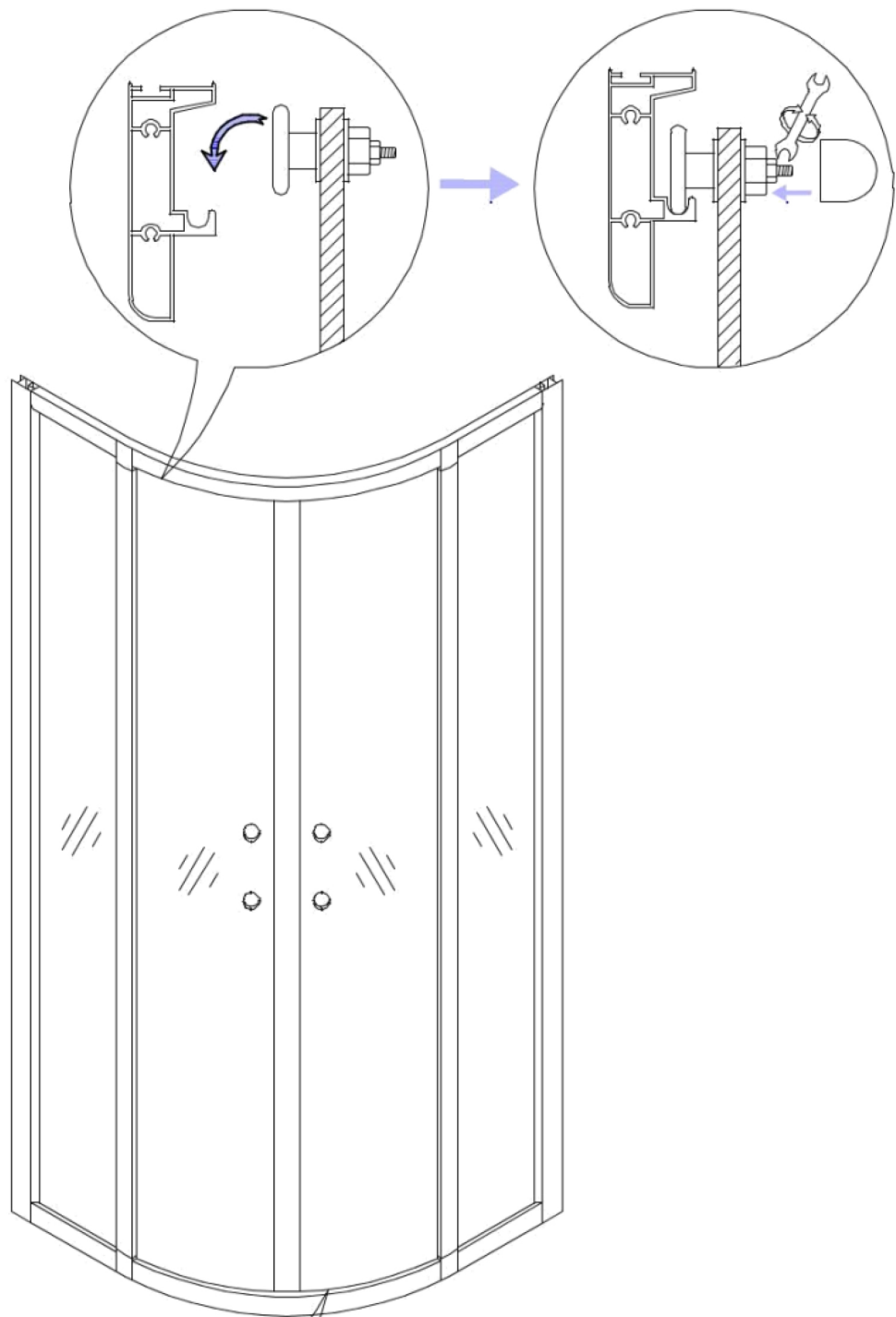



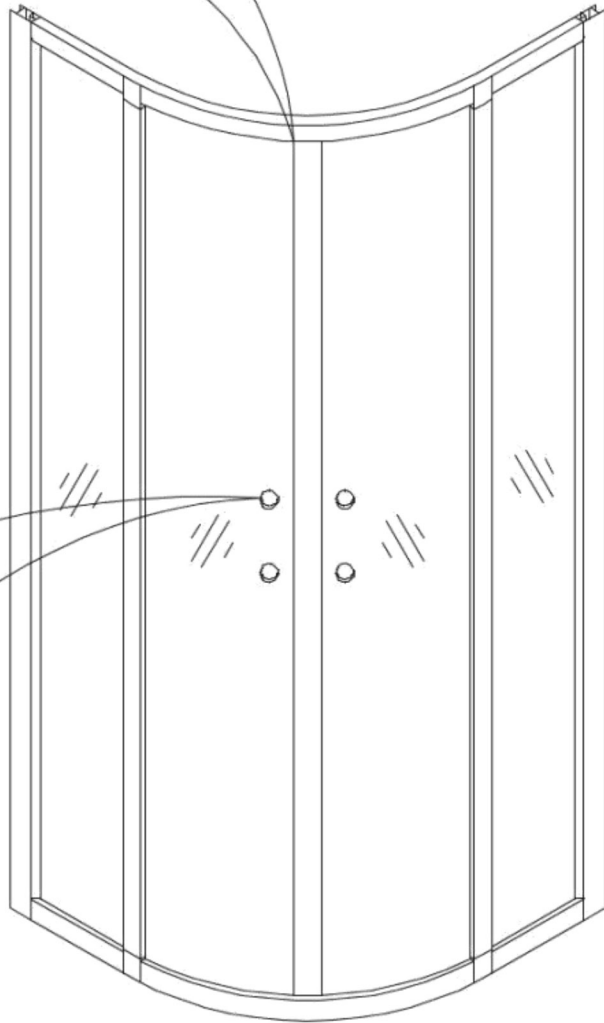
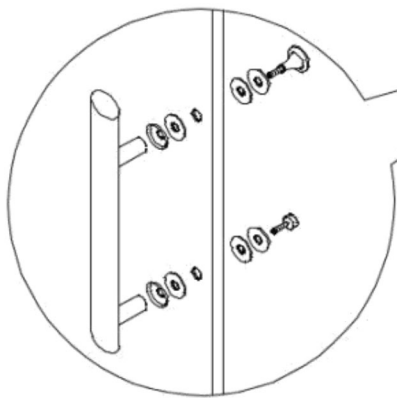
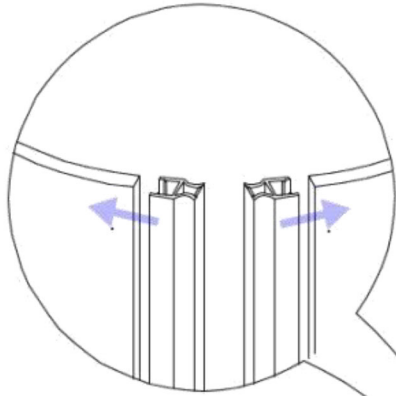
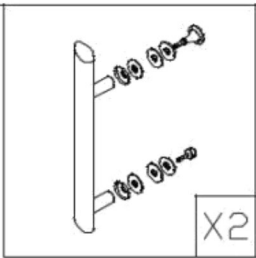
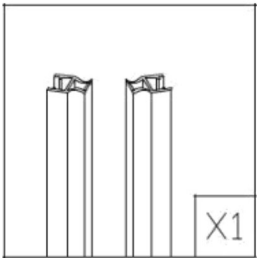

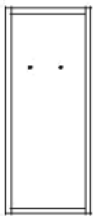

X1

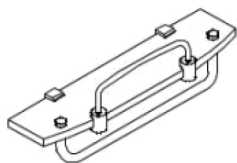

X1

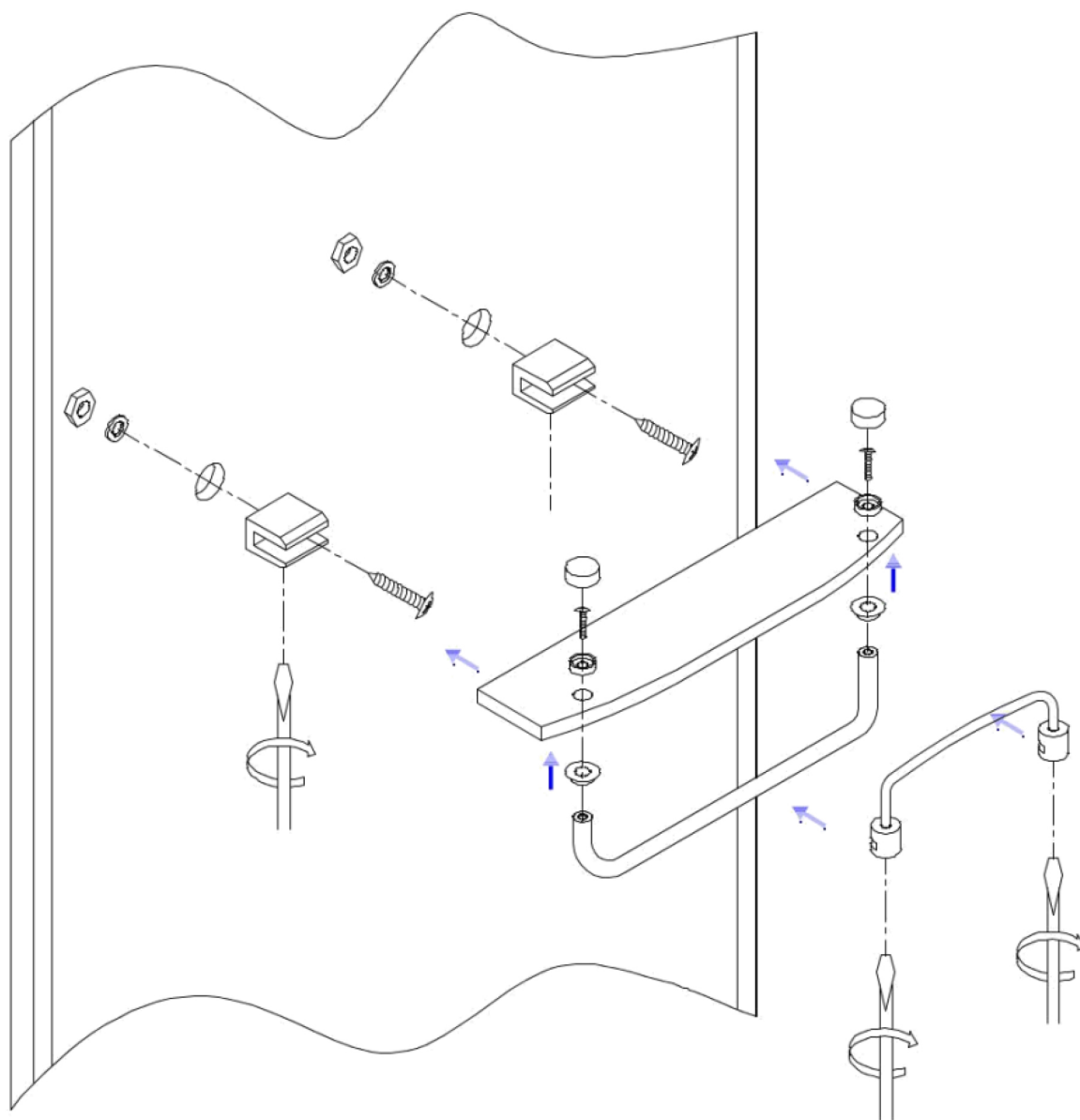
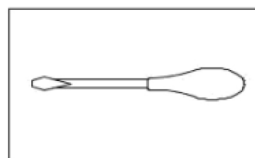
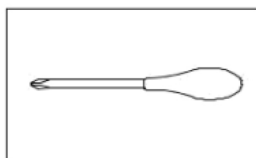

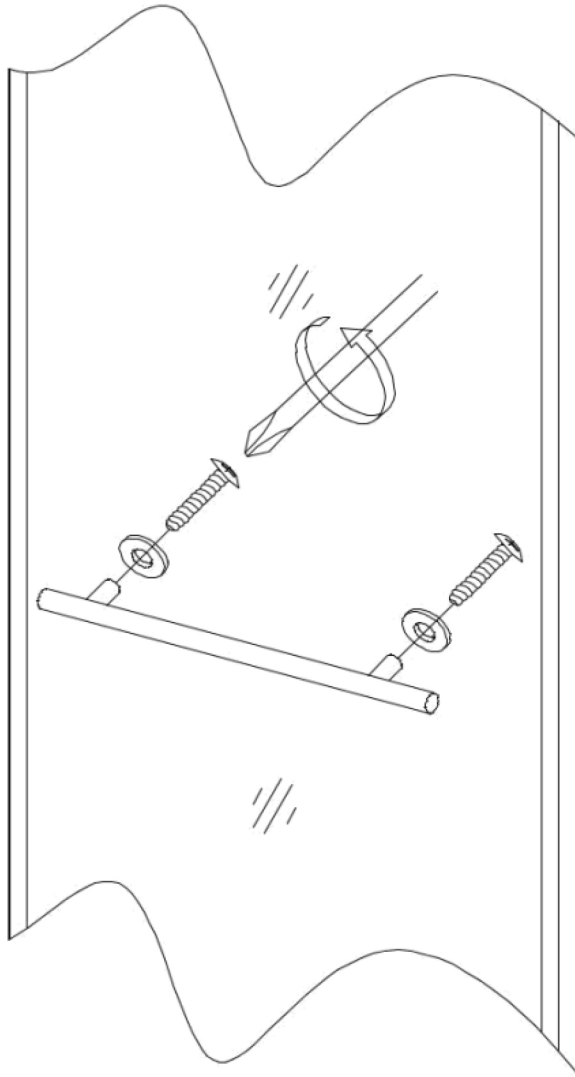
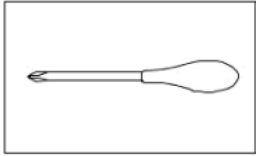
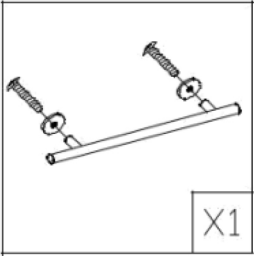

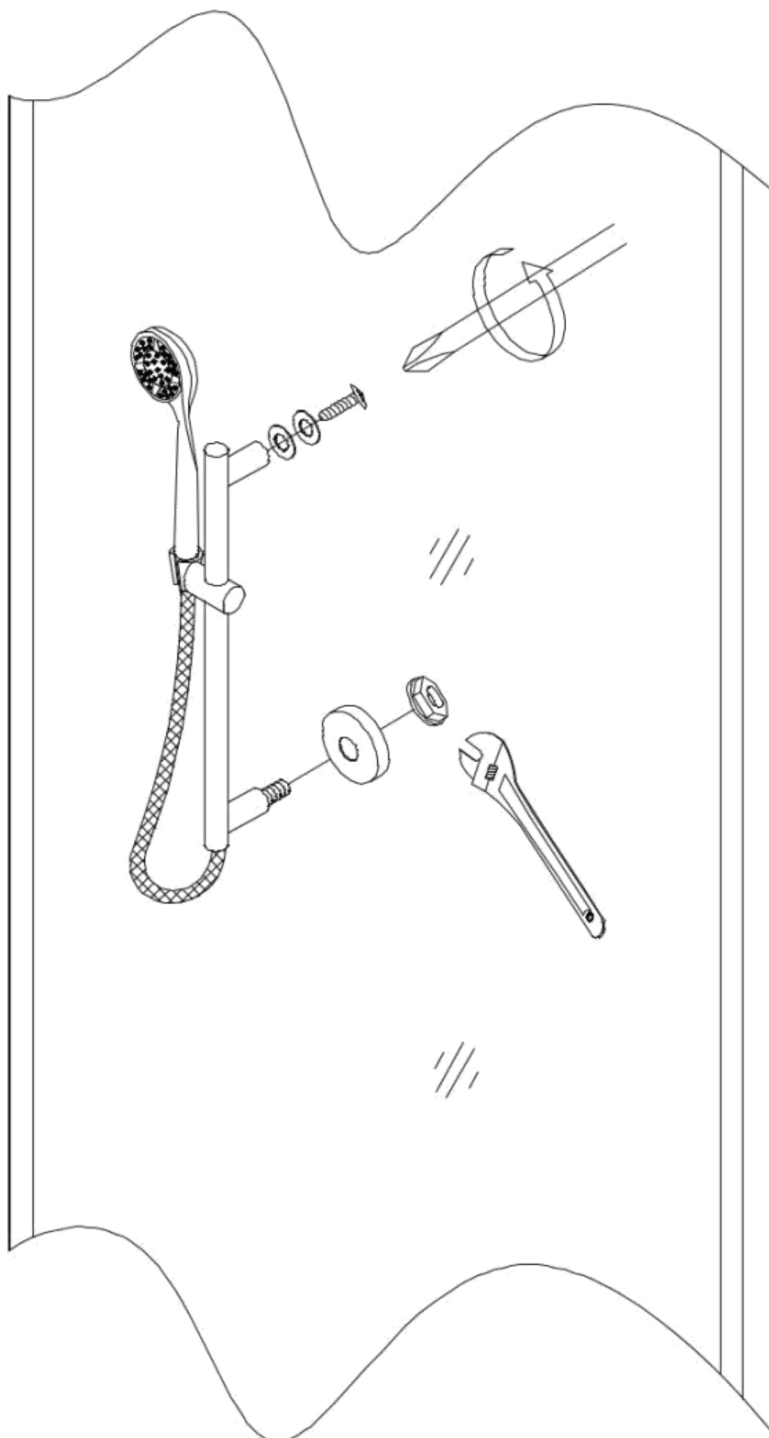
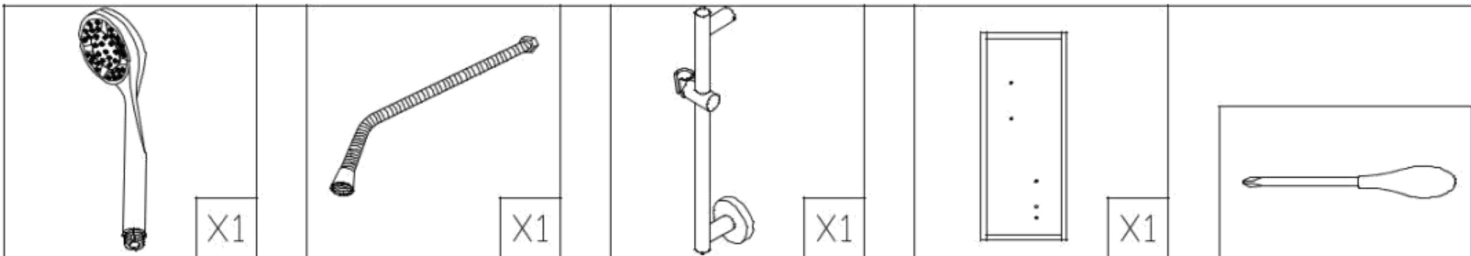

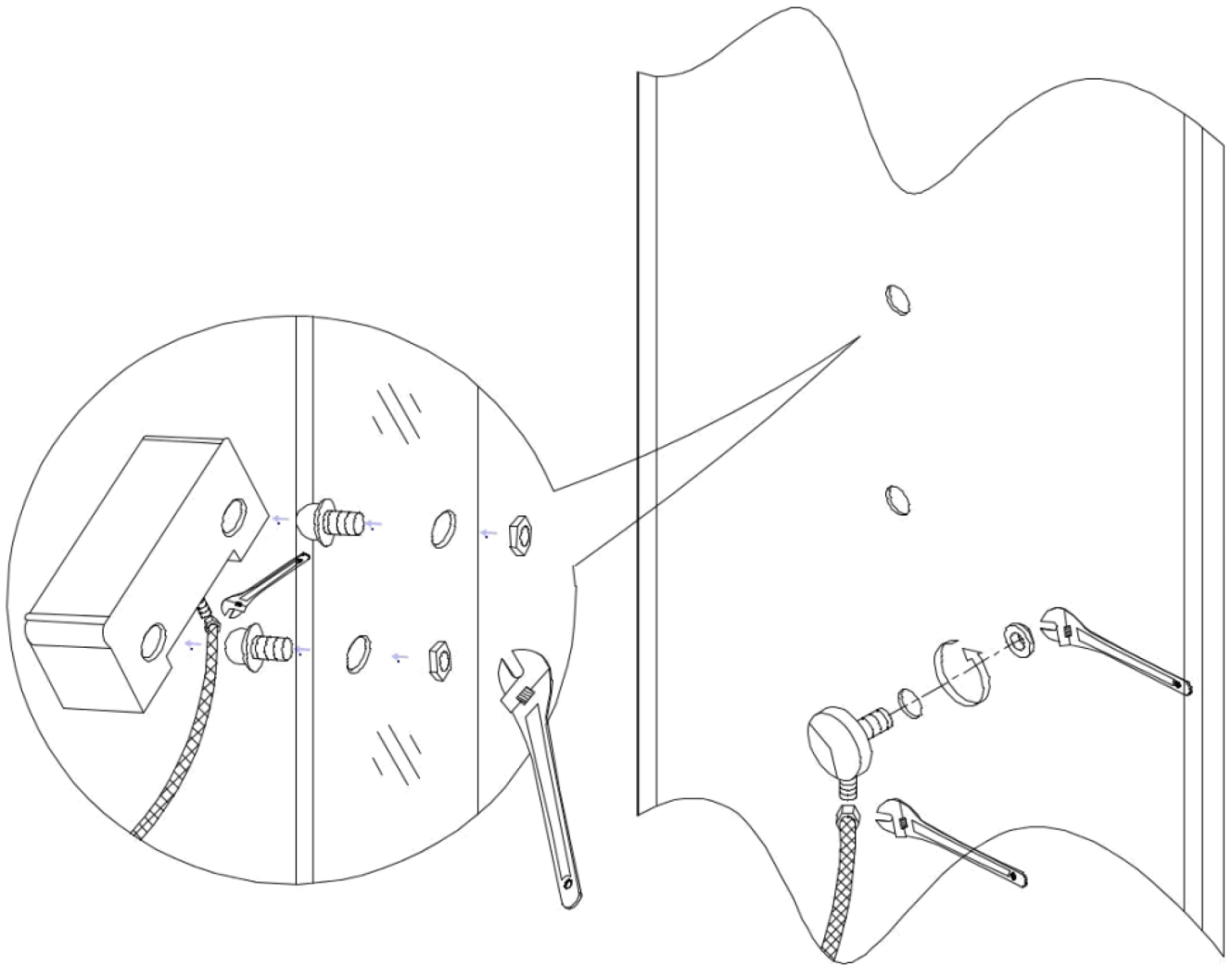
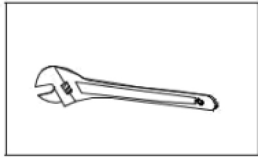
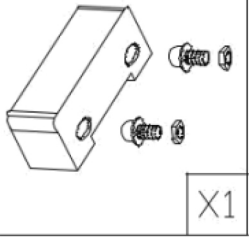



ST4\*16 X10

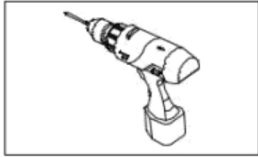

10-ST4\*16

