

VASCA DOCCIA IDROMASSAGGIO

In questo manuale è illustrata la procedura di montaggio della vasca doccia combinata 8007.

Prima di montare la vasca doccia angolare consigliamo di consultare il presente manuale di istruzioni per realizzare il montaggio correttamente.

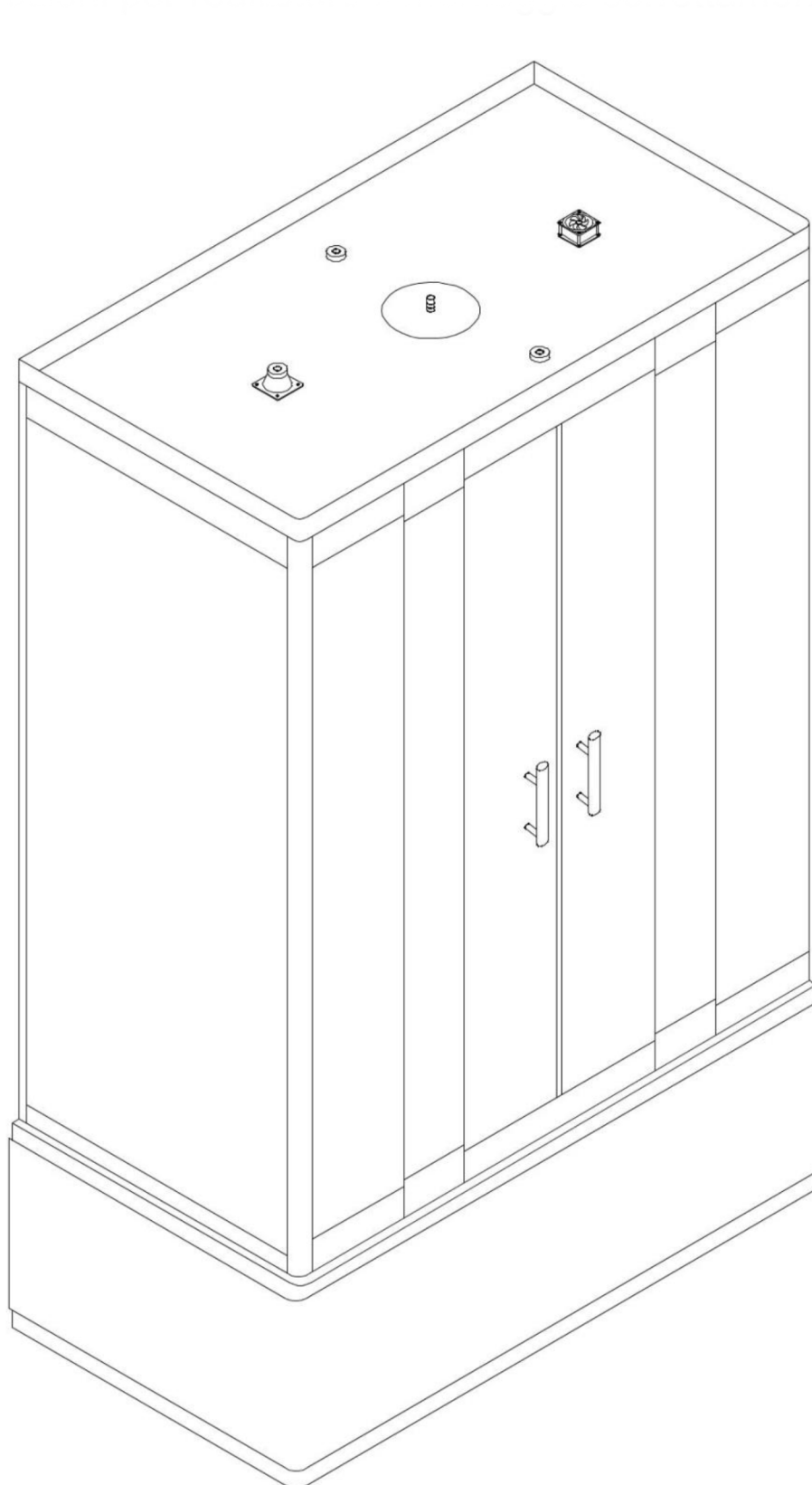

1/3

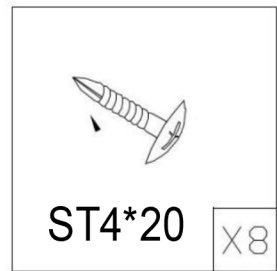
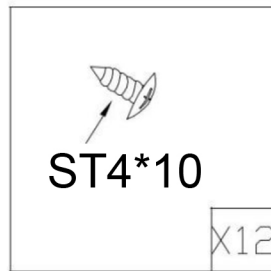
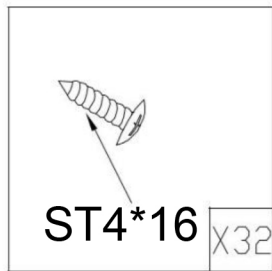
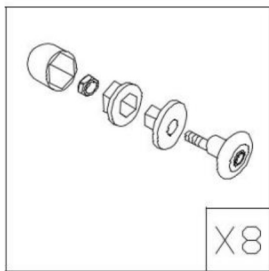
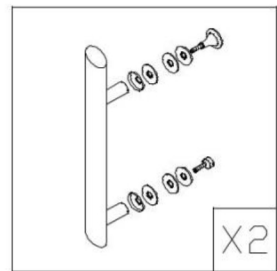
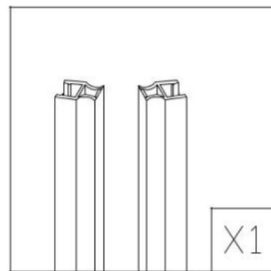
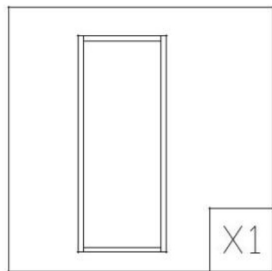
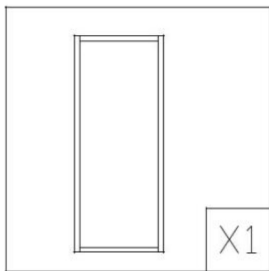
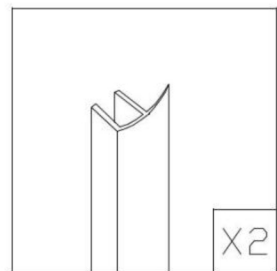
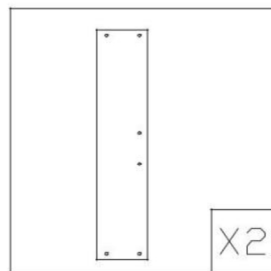
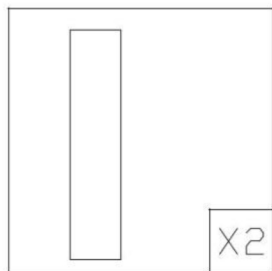
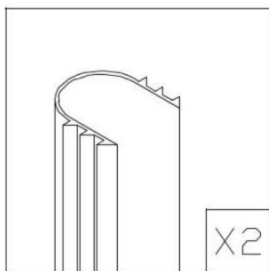
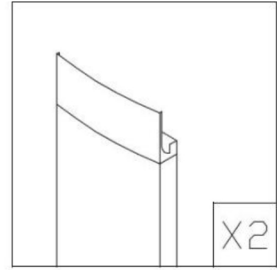
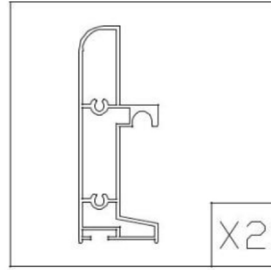
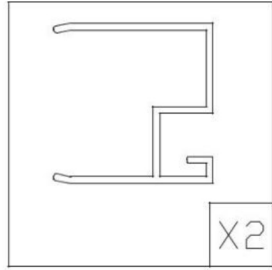
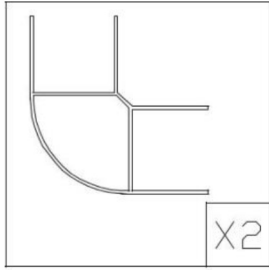
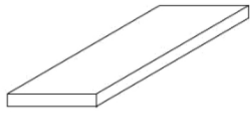

2/3

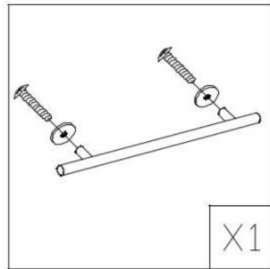
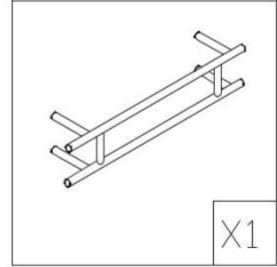
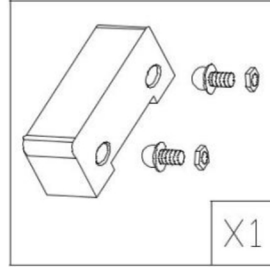
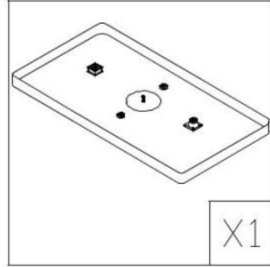
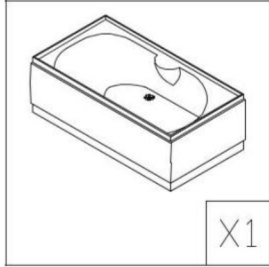
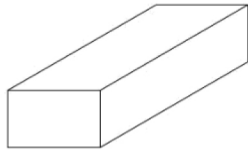

3/3

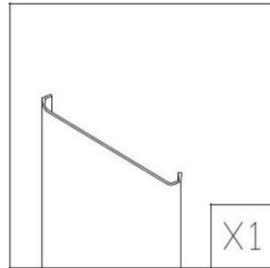
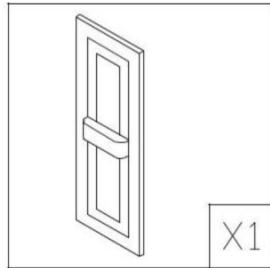
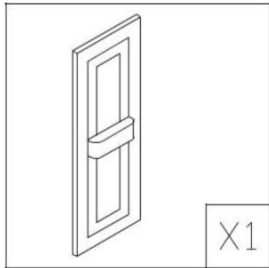
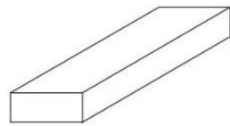

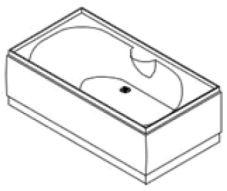

X1

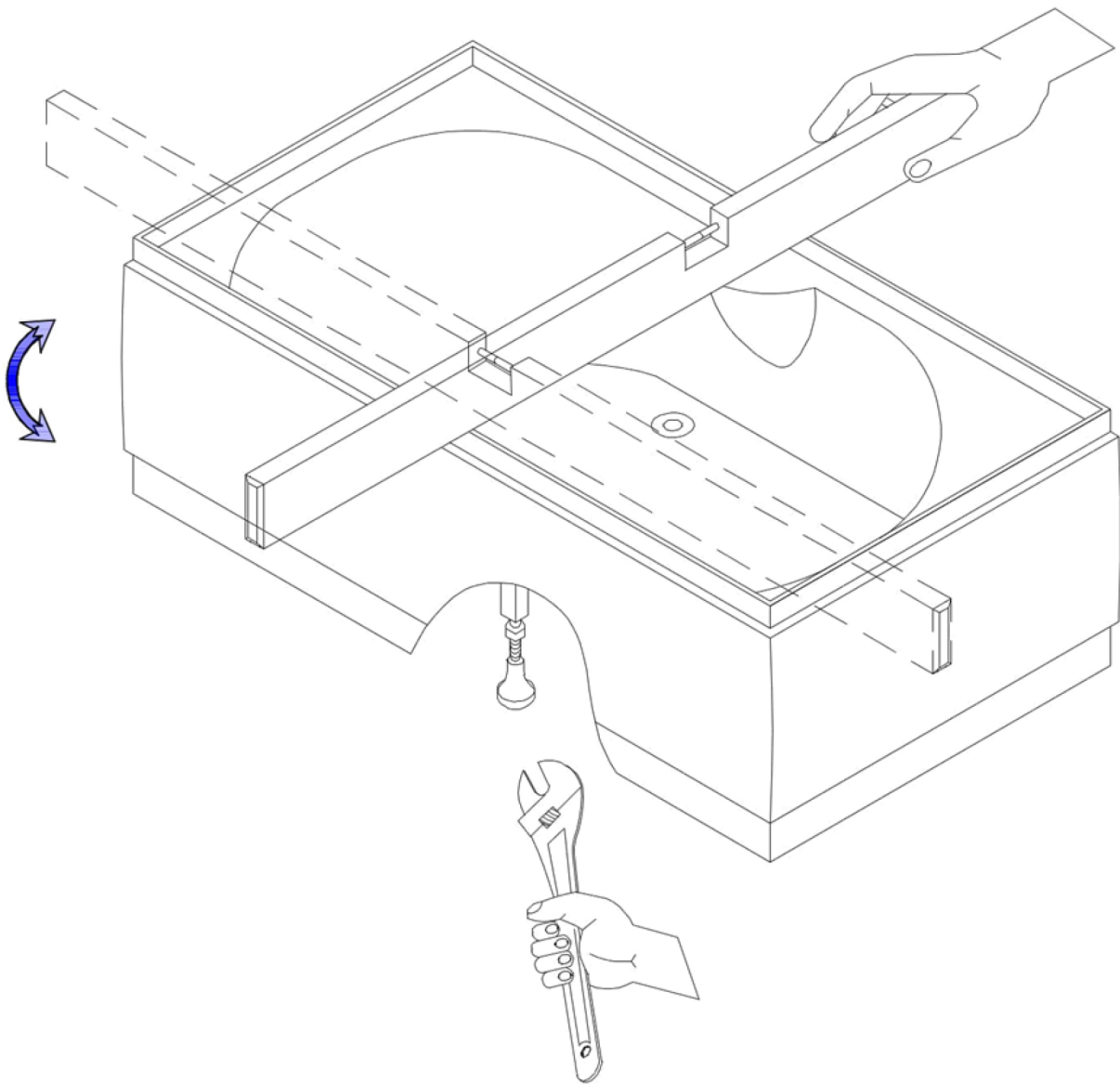
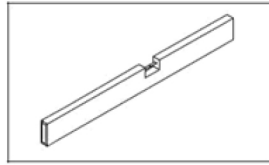
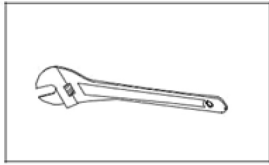



X2

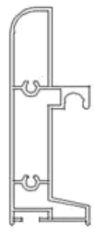

X2



ST4*16

X8

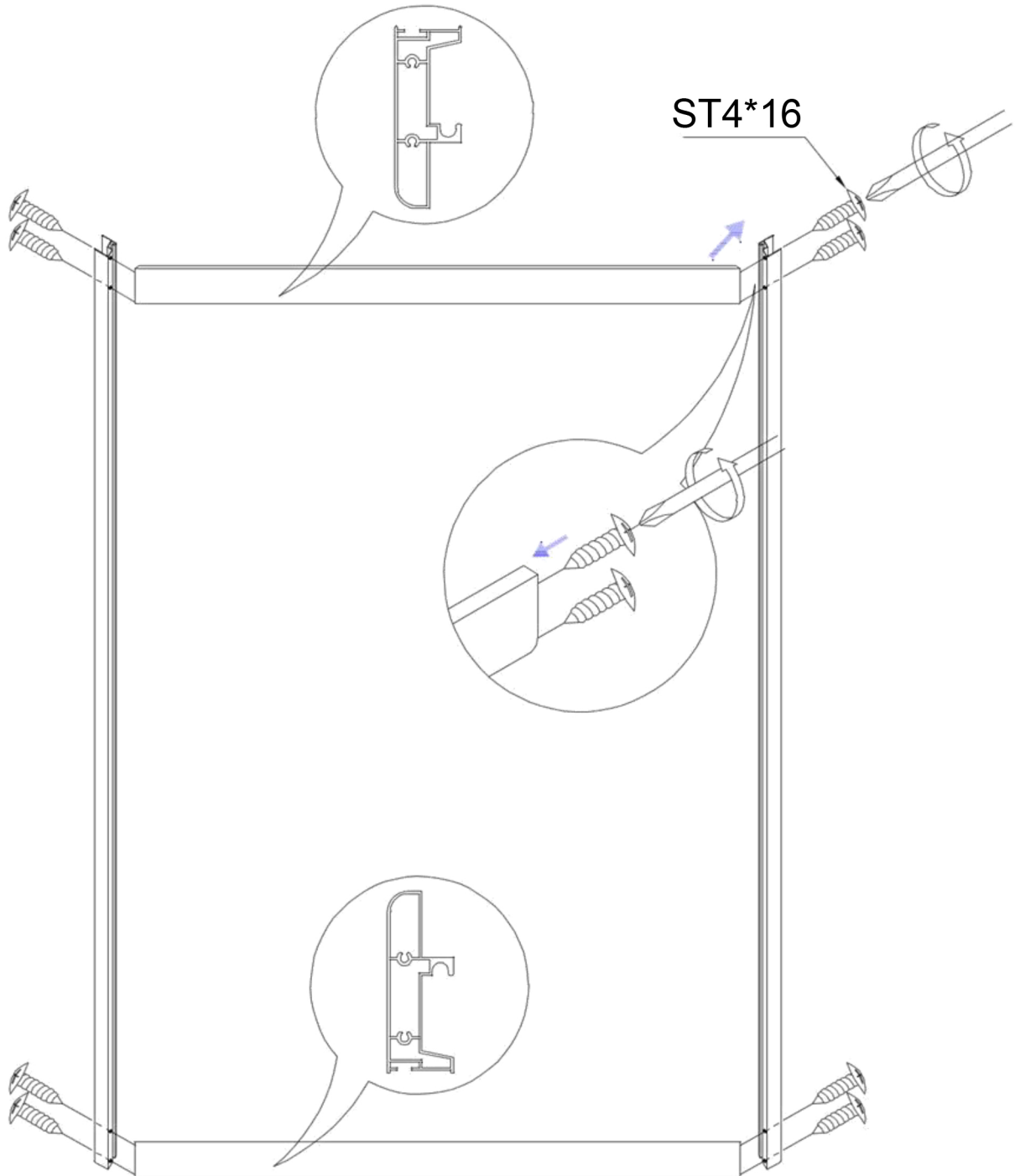

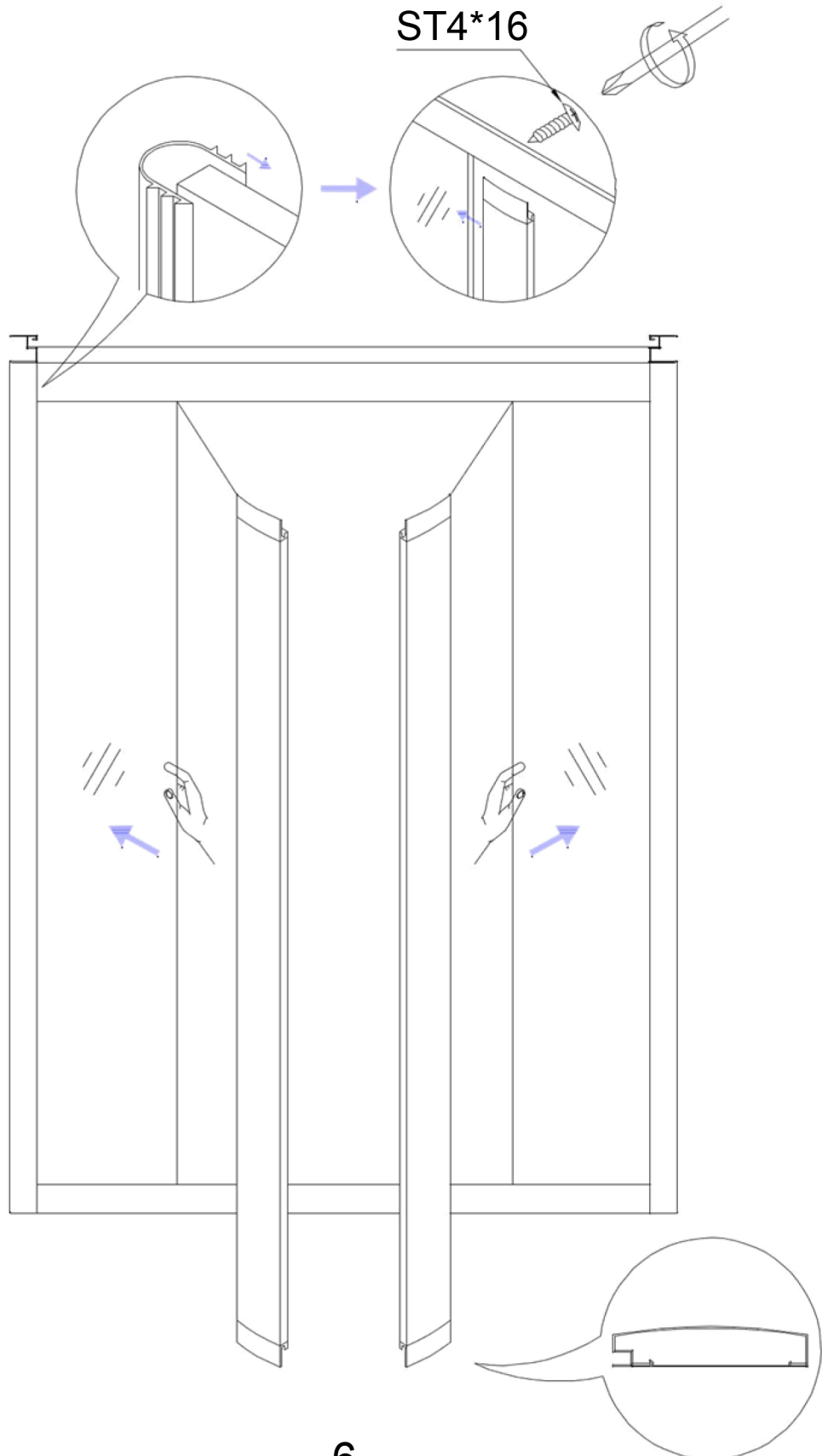
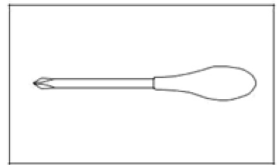
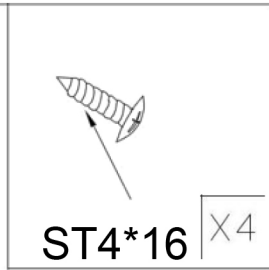
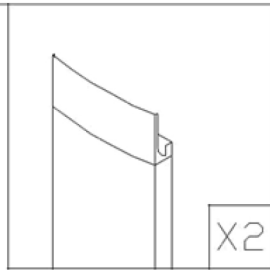
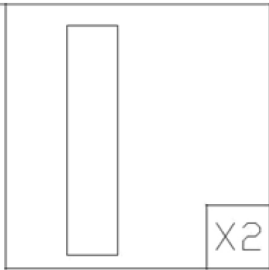
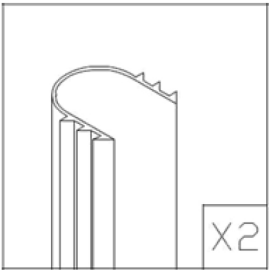

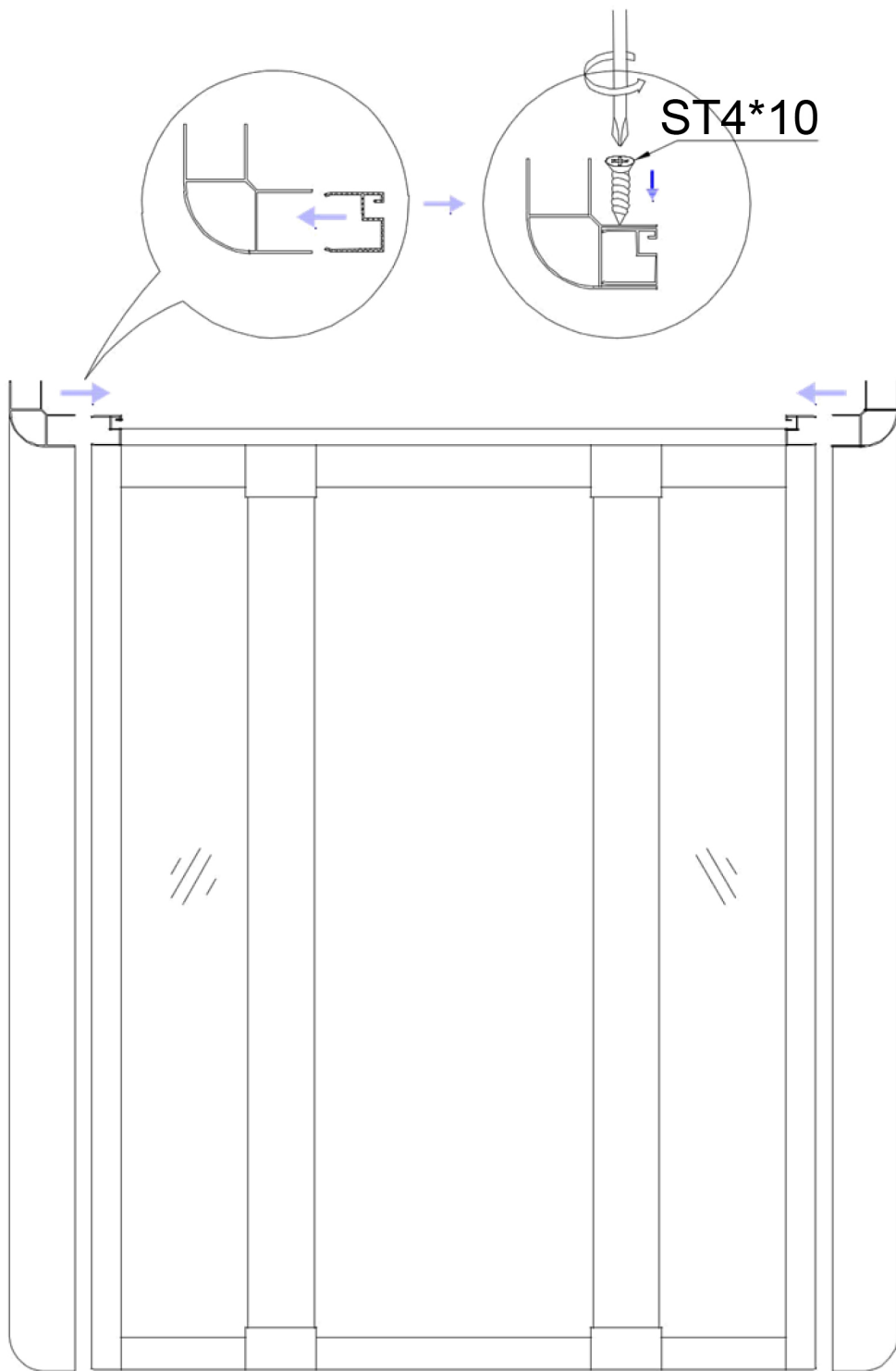
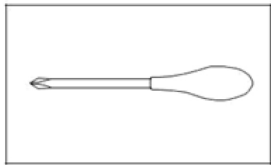
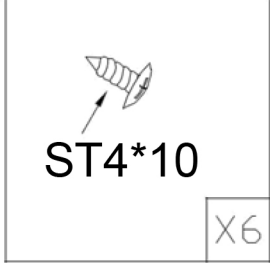
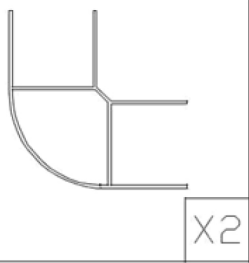

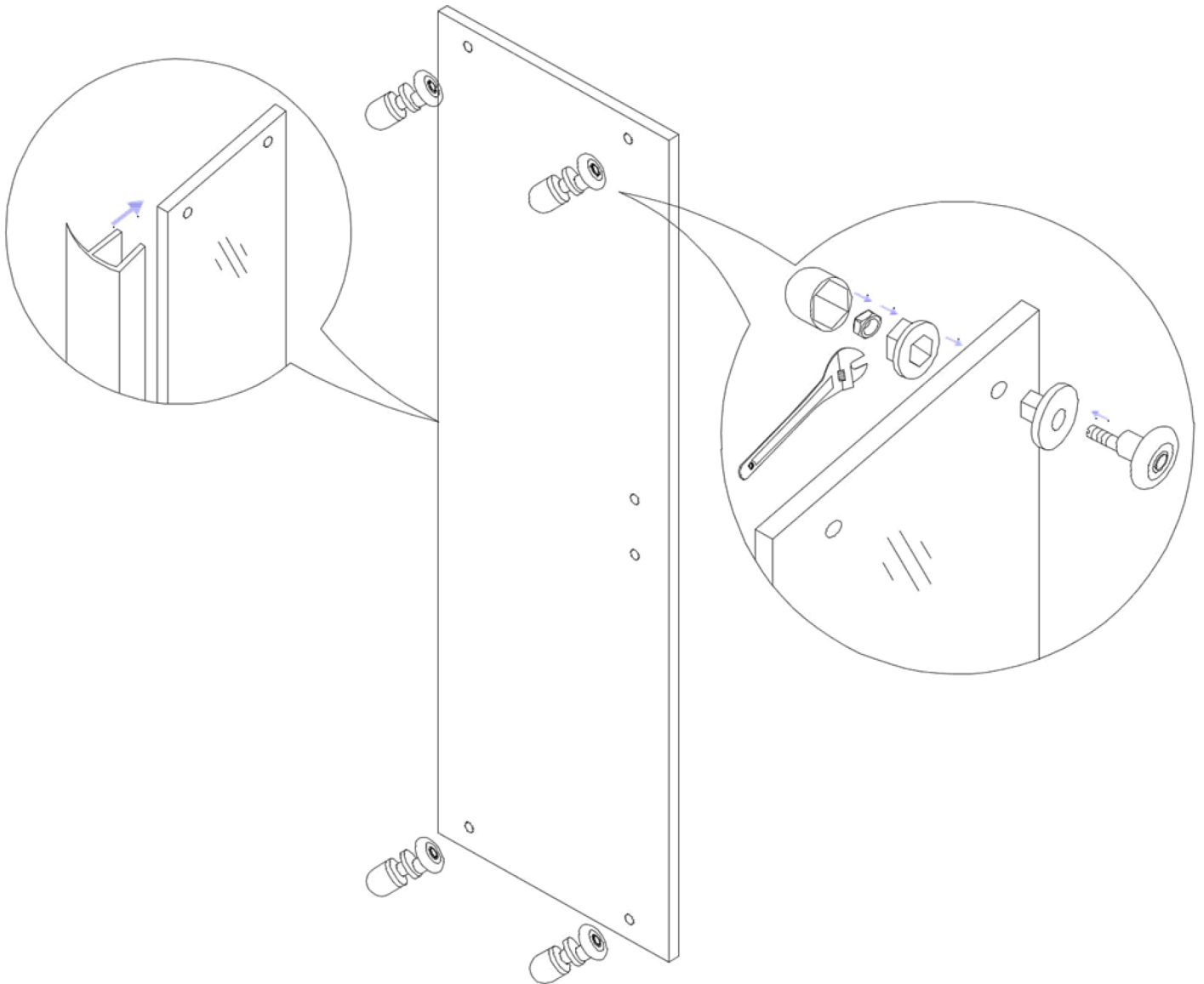
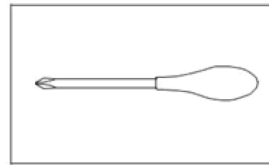
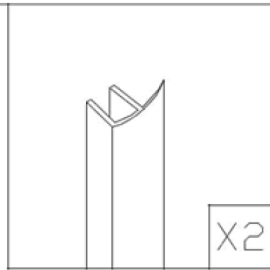
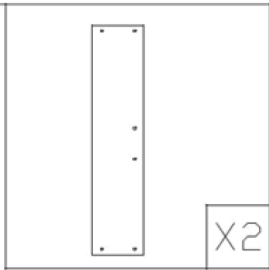
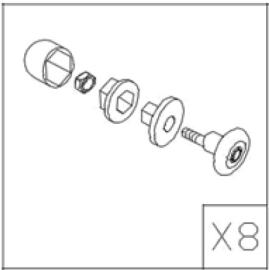

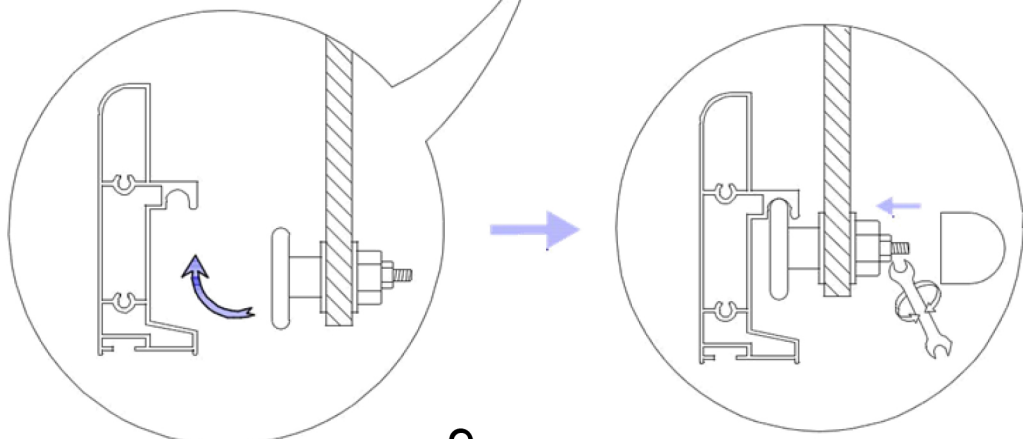
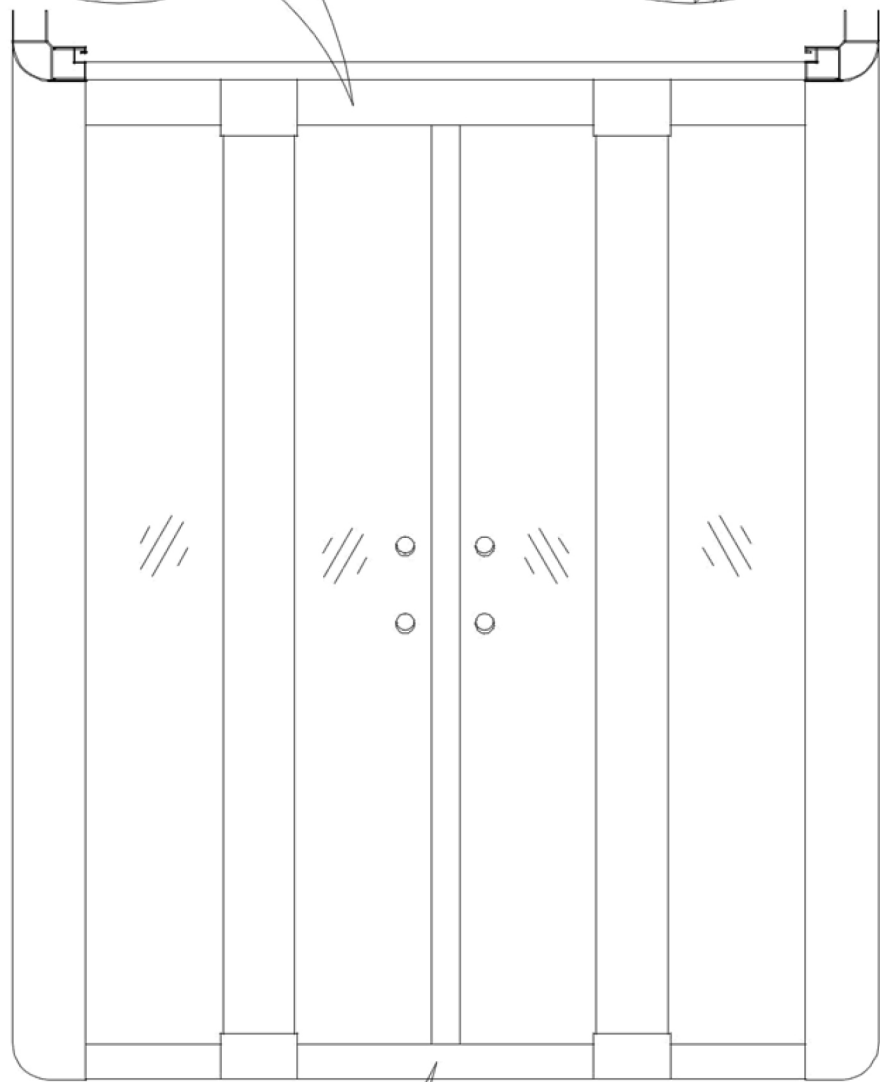
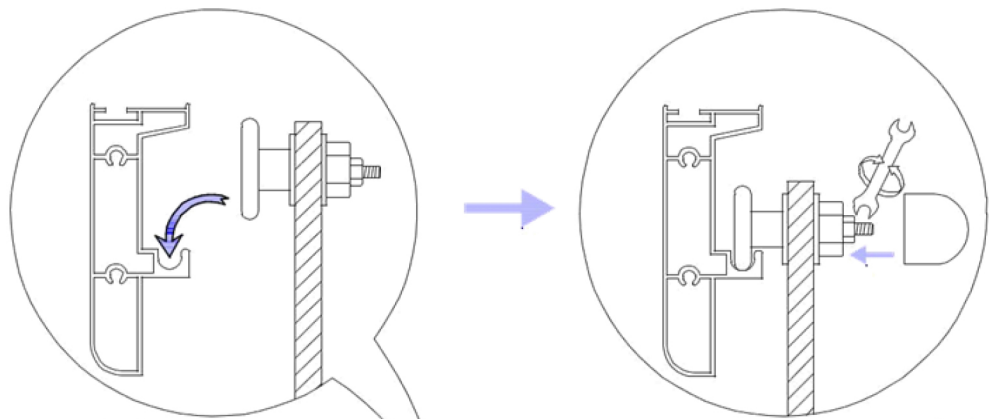

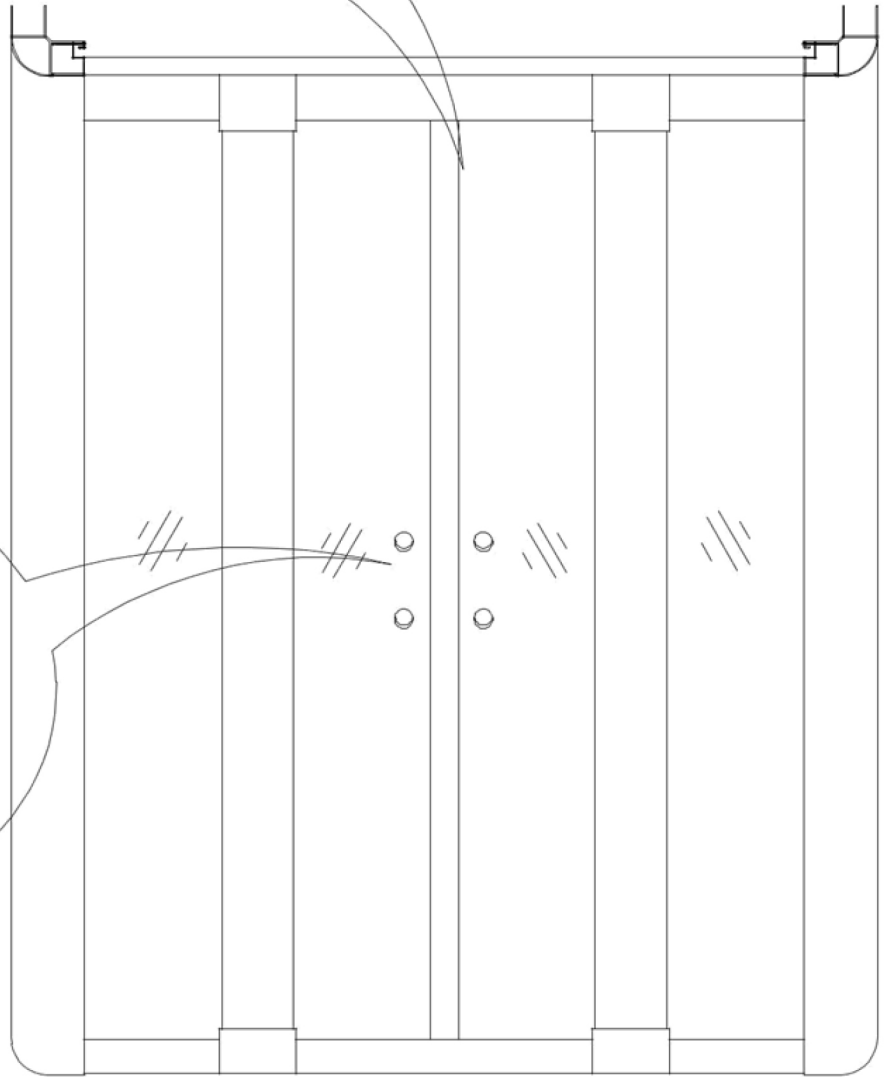
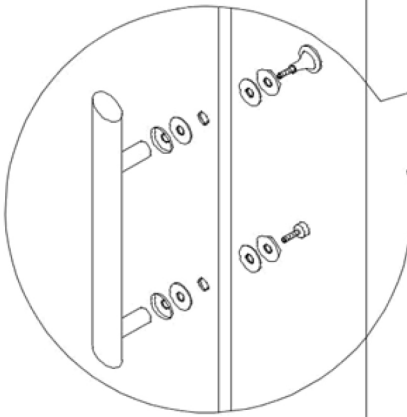
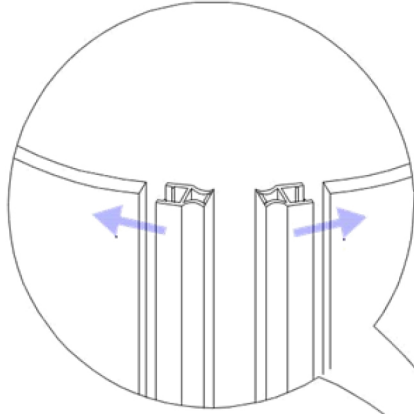
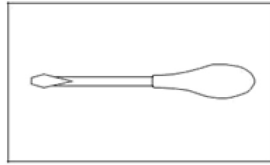
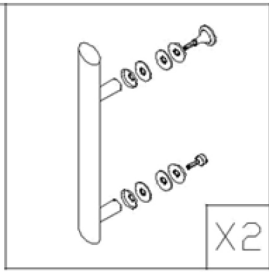
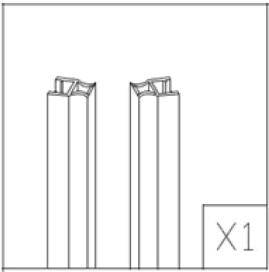



X1



X1

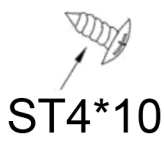

ST4*10

X6

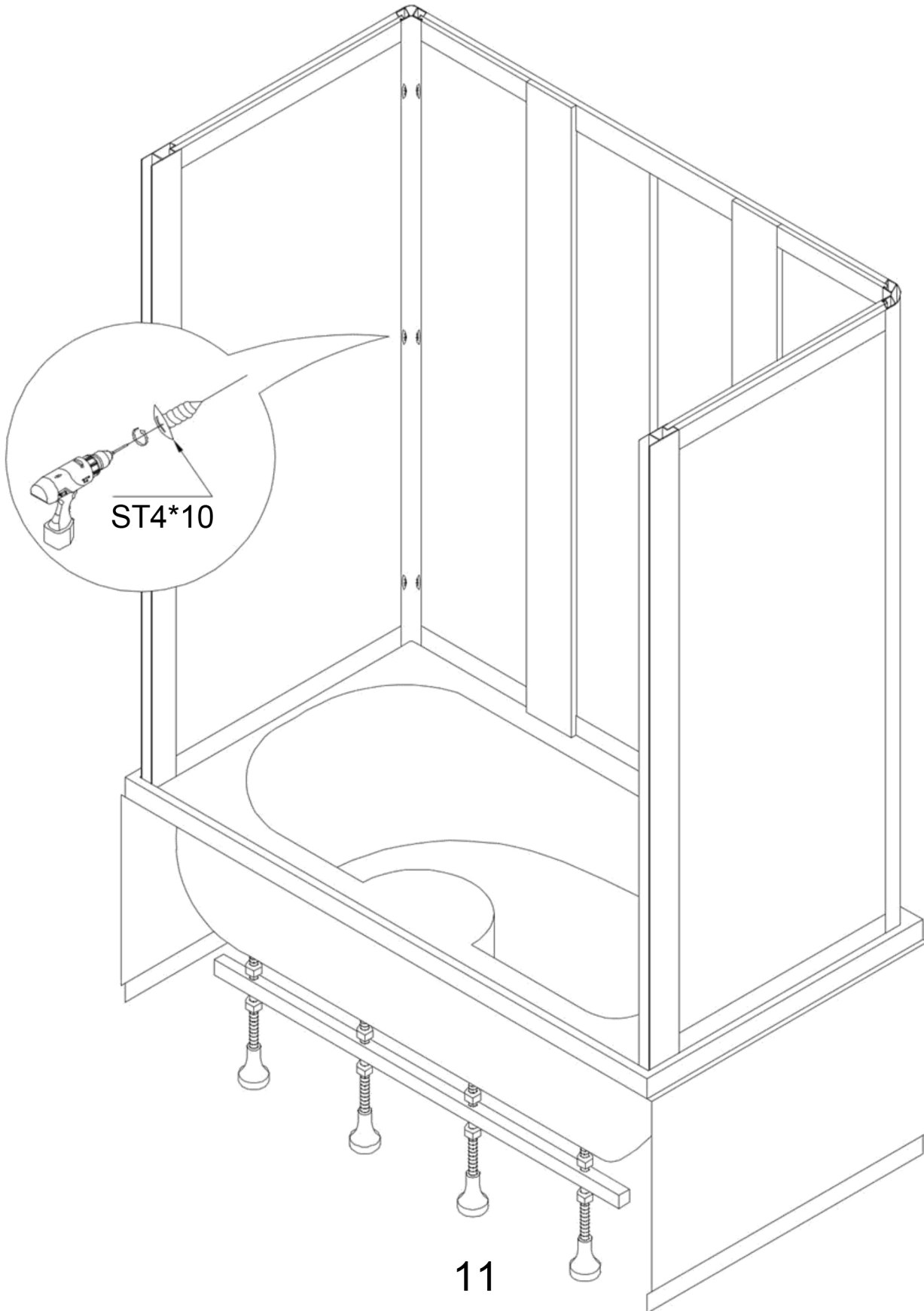

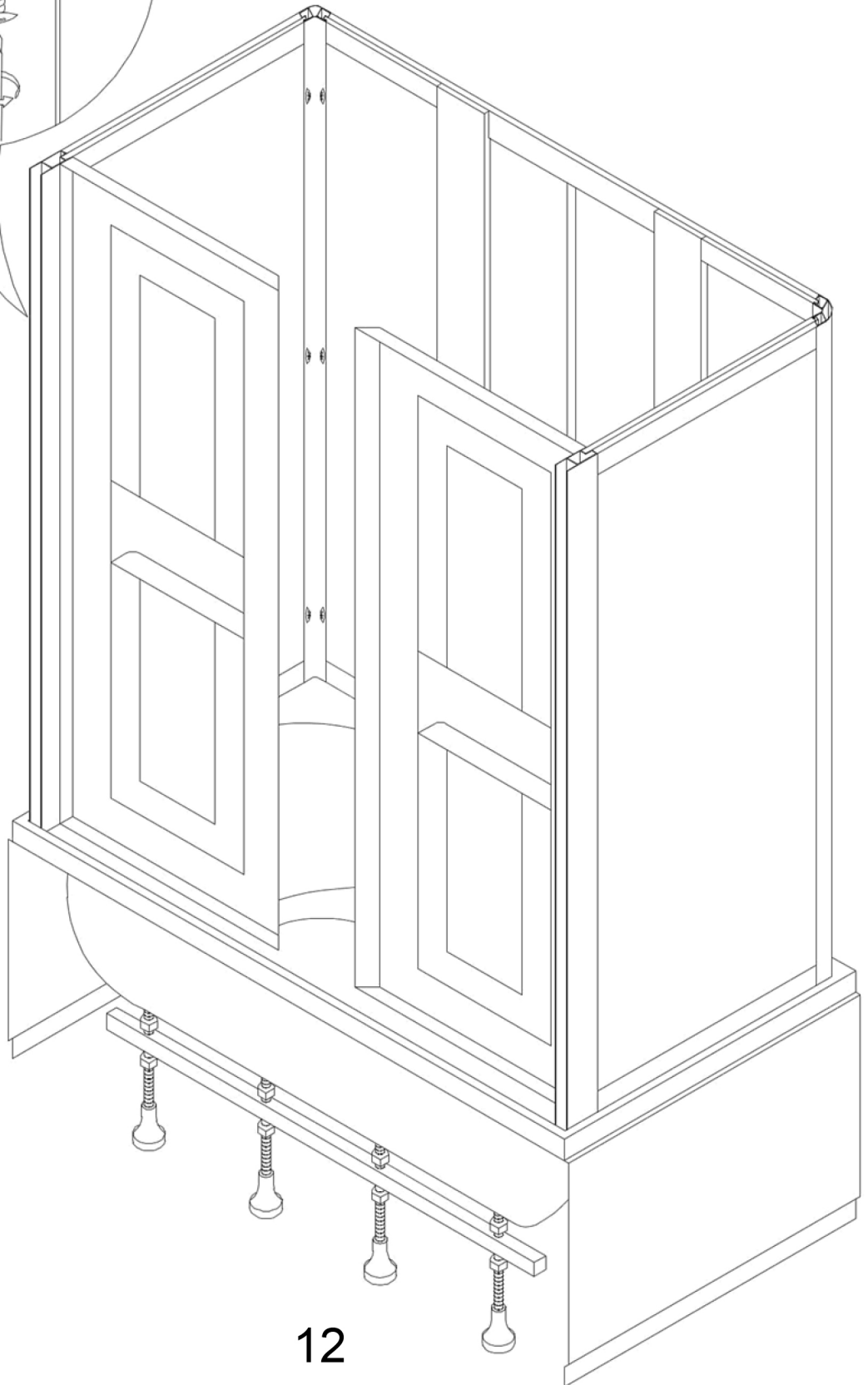
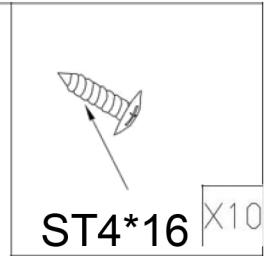
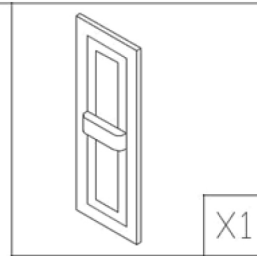
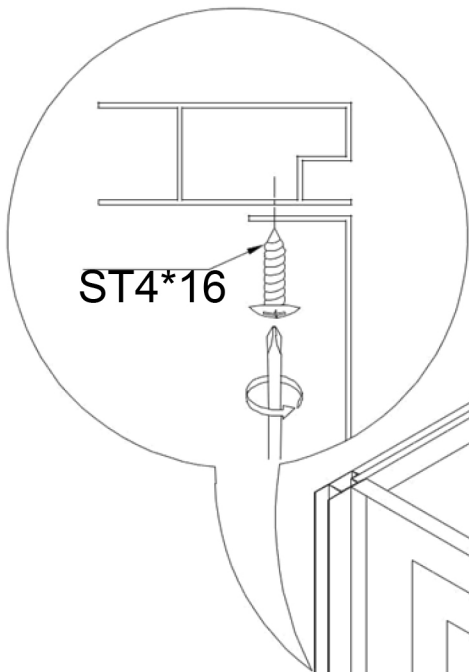



X1



ST4*16

X10

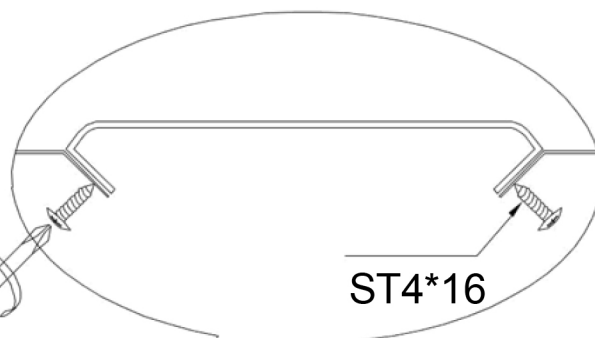

ST4*16

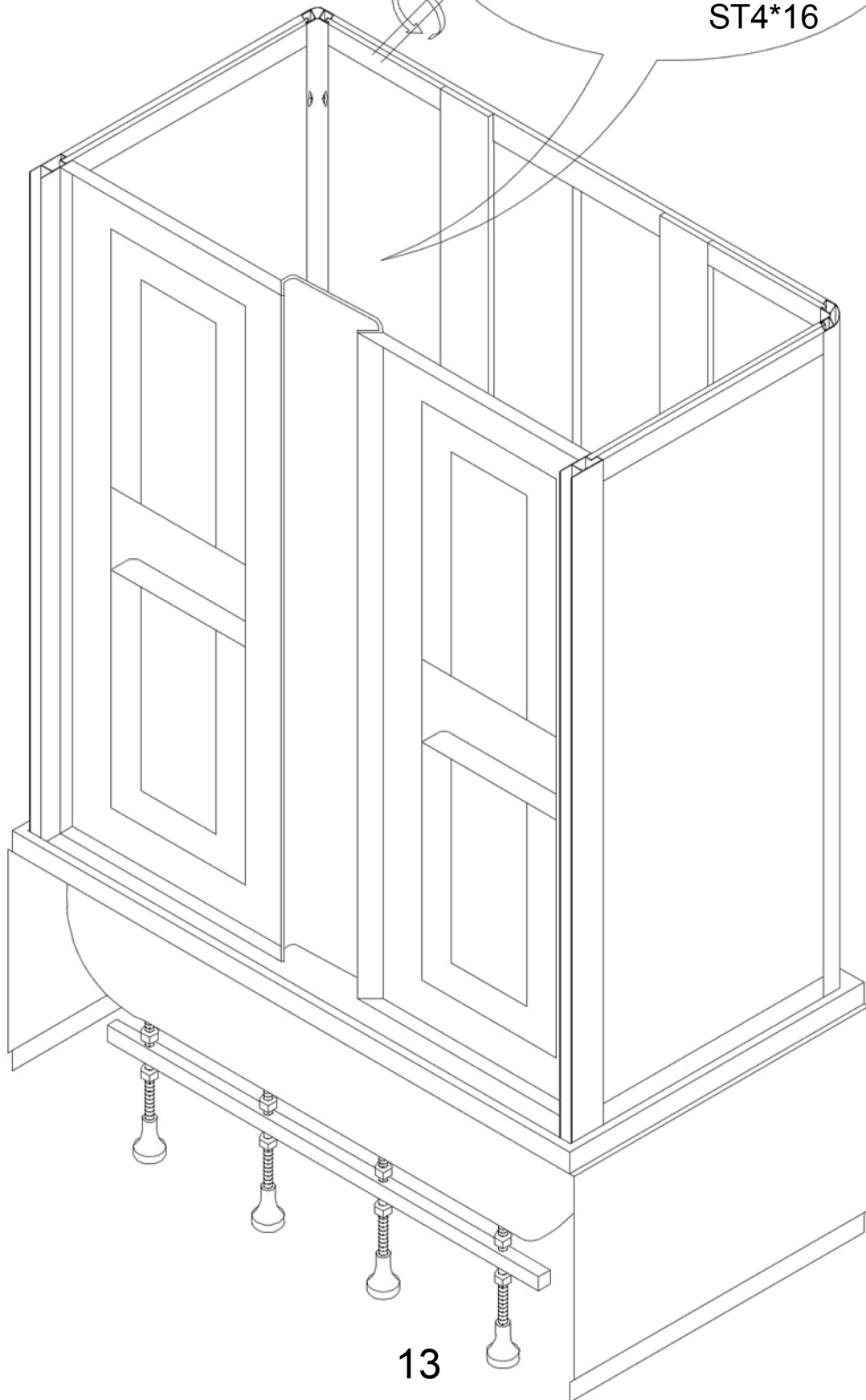



ST4*20 XØ

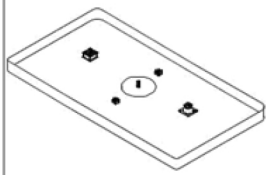

X1

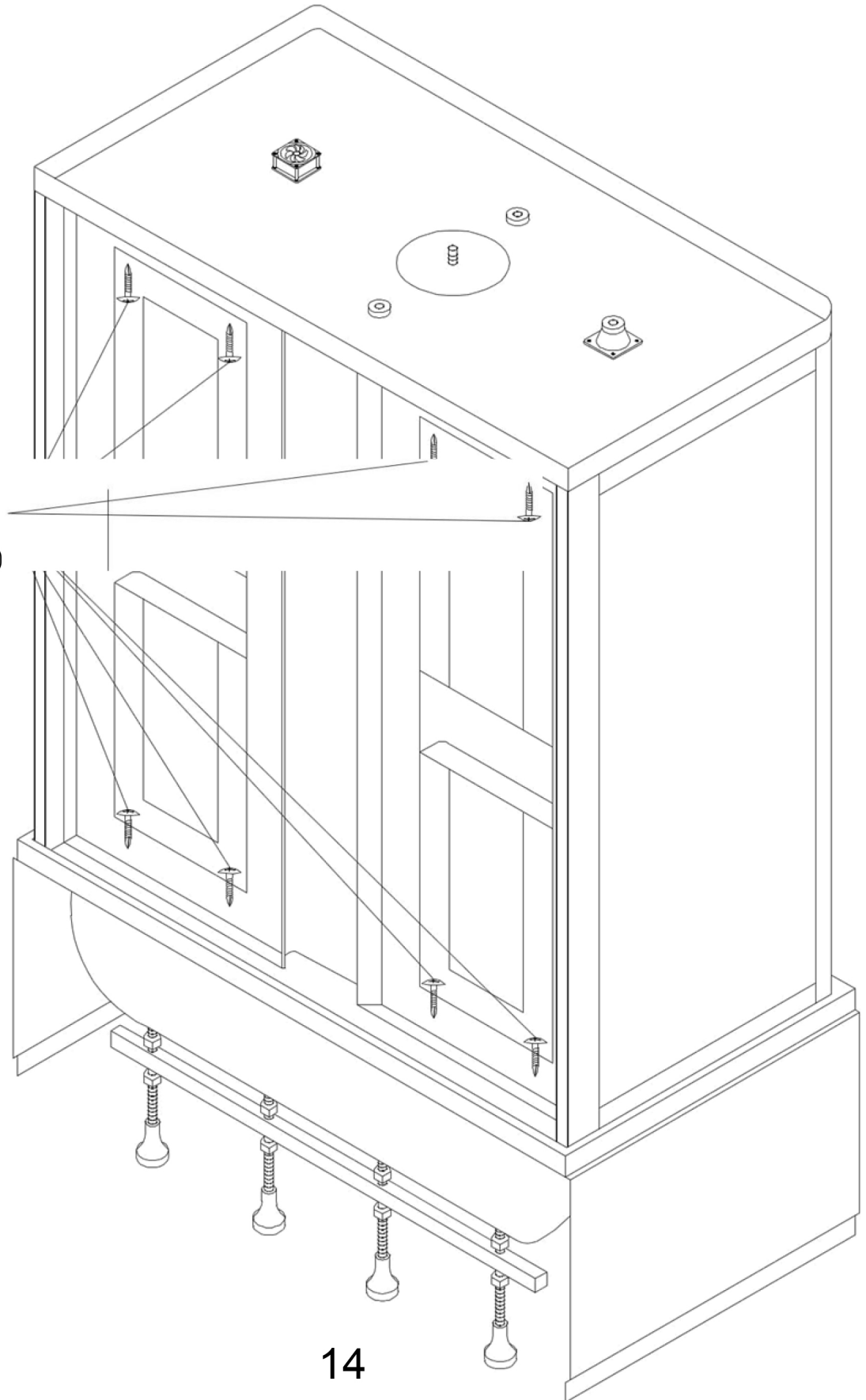

4-ST4*20

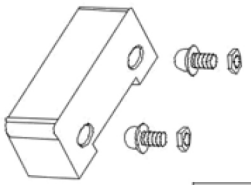

X1

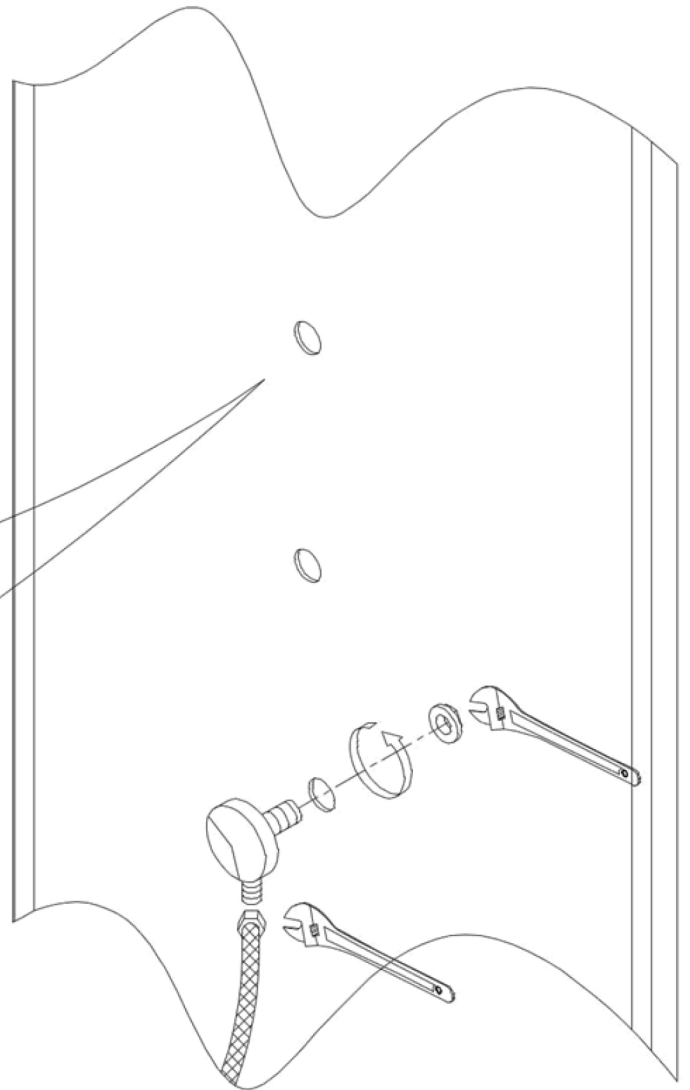
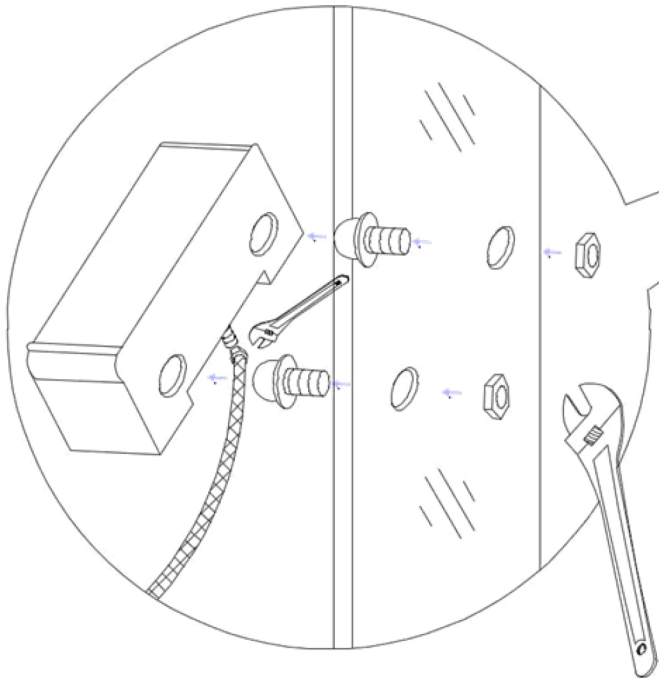
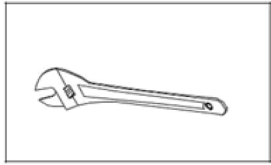

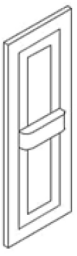

X1

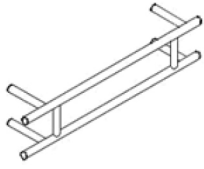

X1

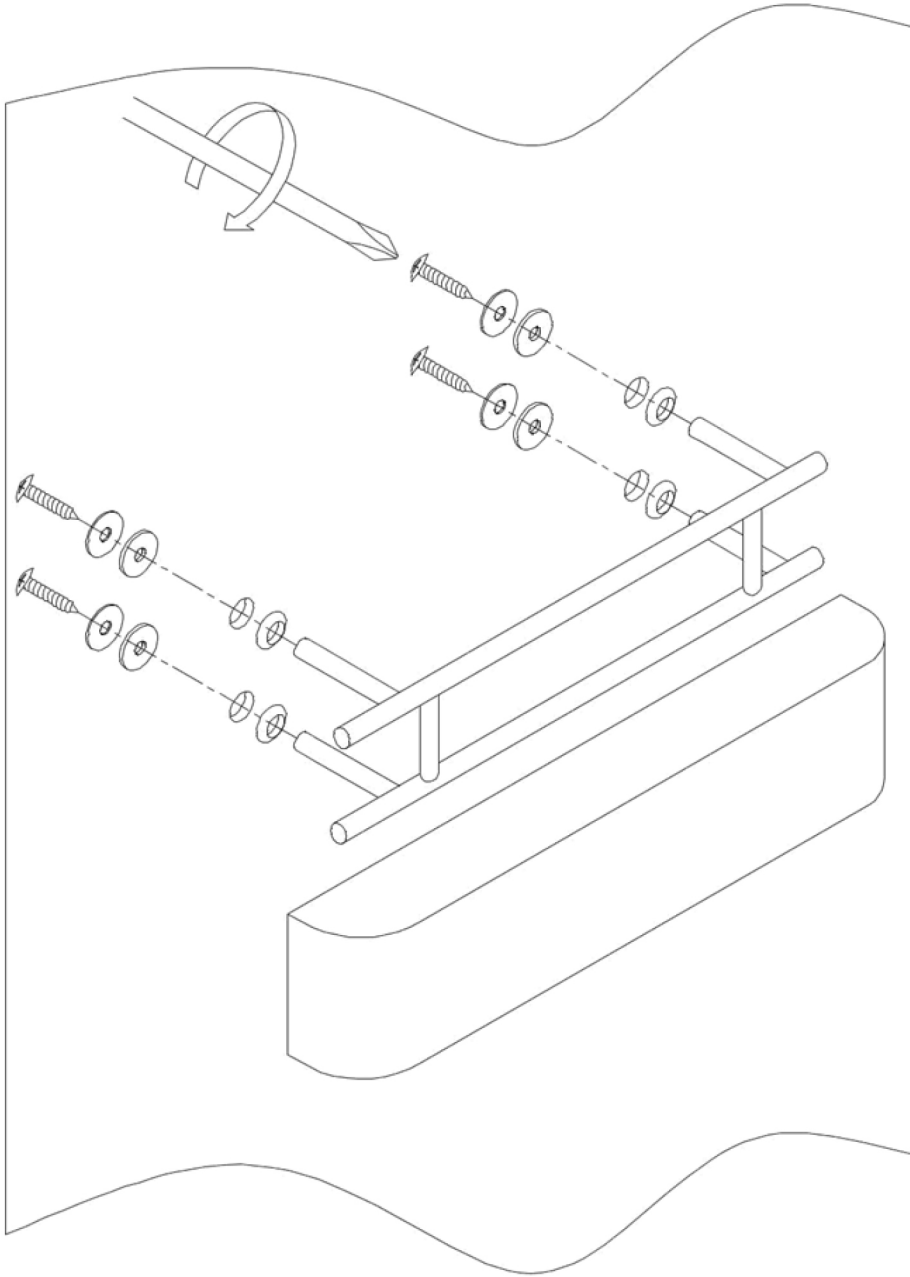
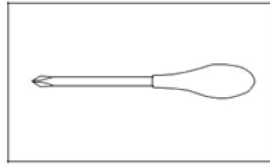



X1

