

# DOCCIA IDROMASSAGGIO

## Box doccia idromassaggio

In questo manuale è illustrata la procedura di montaggio della **cabina doccia idromassaggio** . Prima di effettuare il montaggio consigliamo di consultare il presente manuale di istruzioni per effettuare un montaggio a regola d'arte.

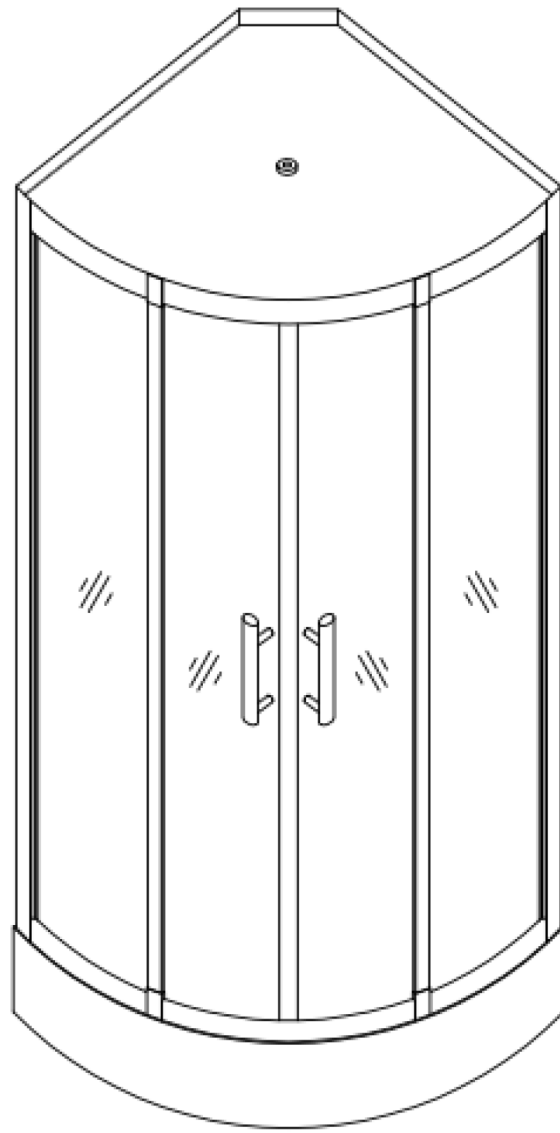

1/4

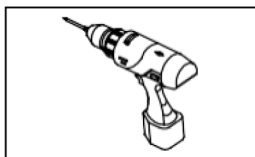
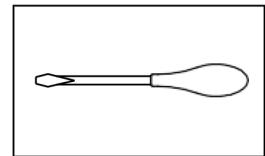
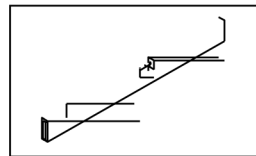
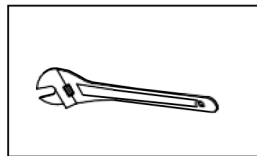
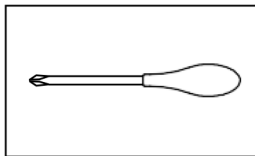
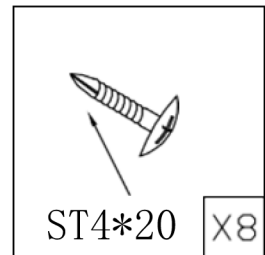
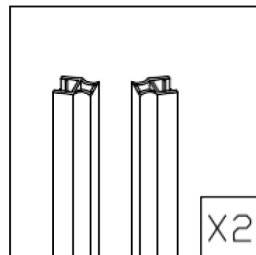
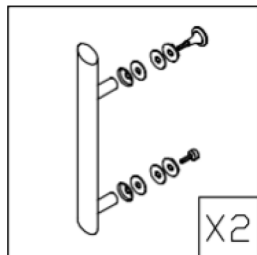
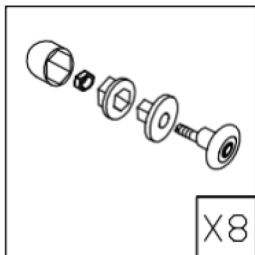
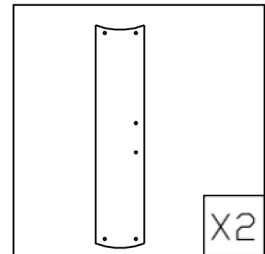
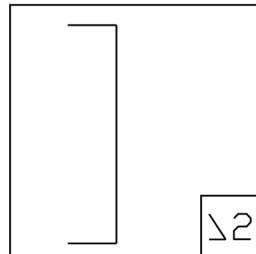
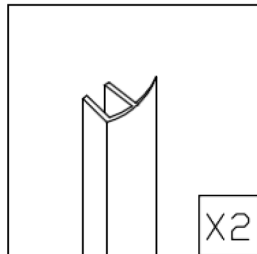
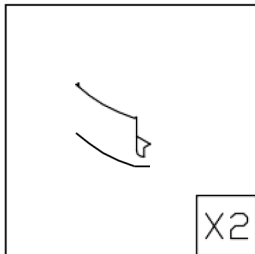
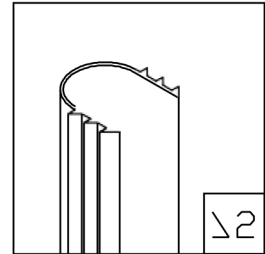
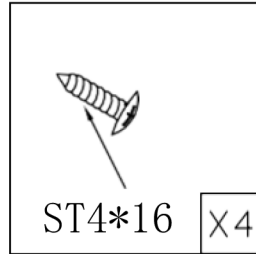
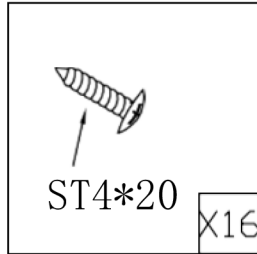
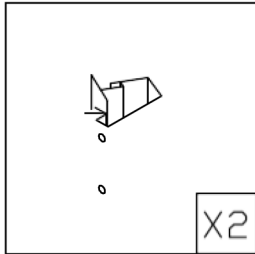
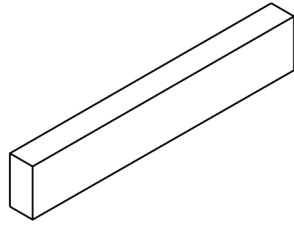

2/4

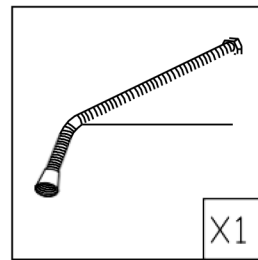
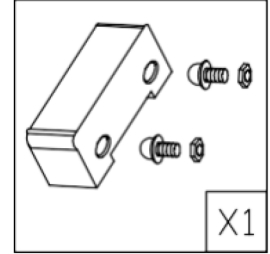
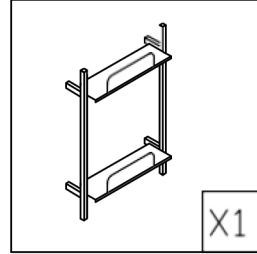
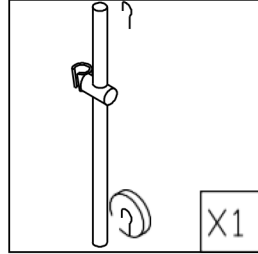
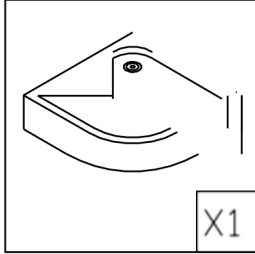
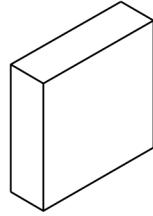

3/4

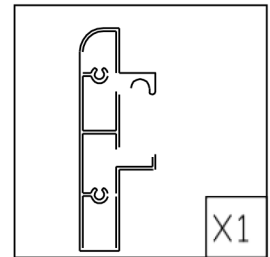
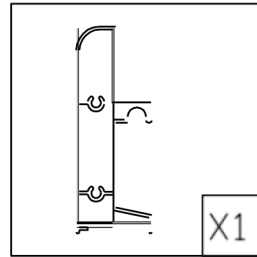
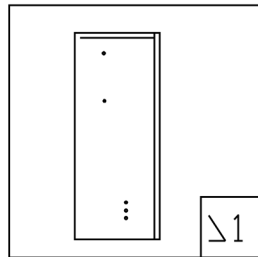
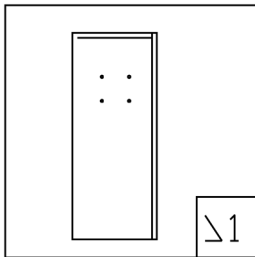
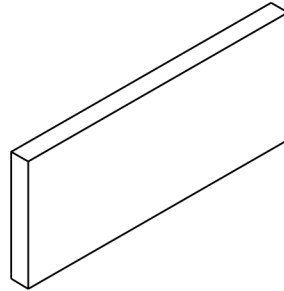

4/4

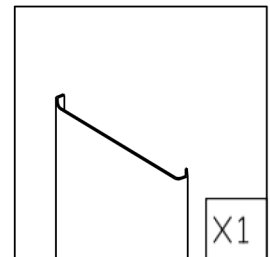
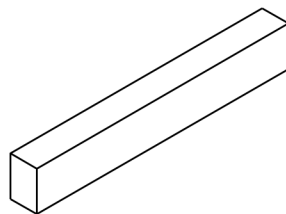

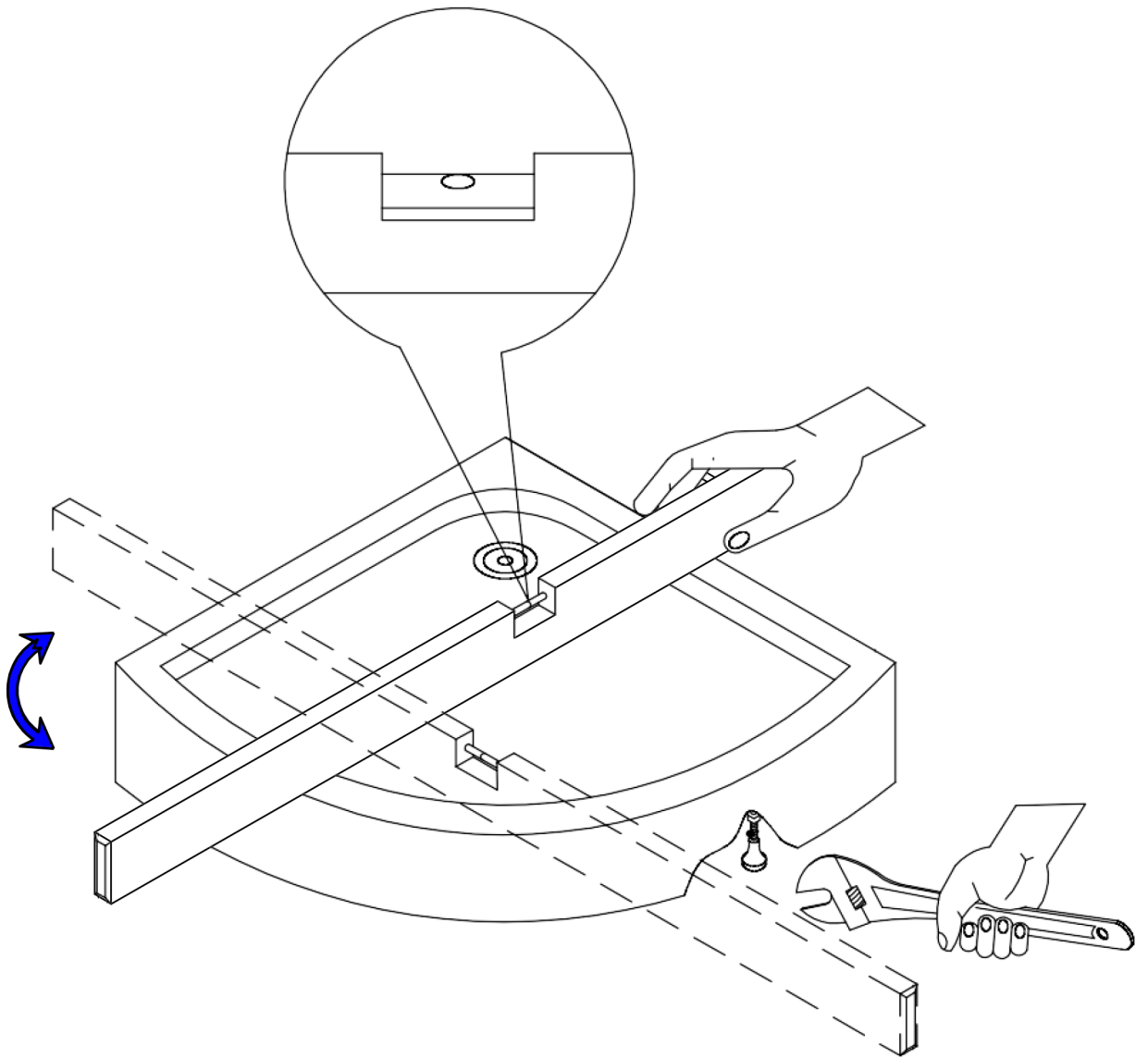
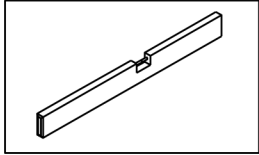
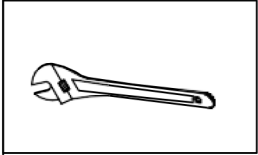

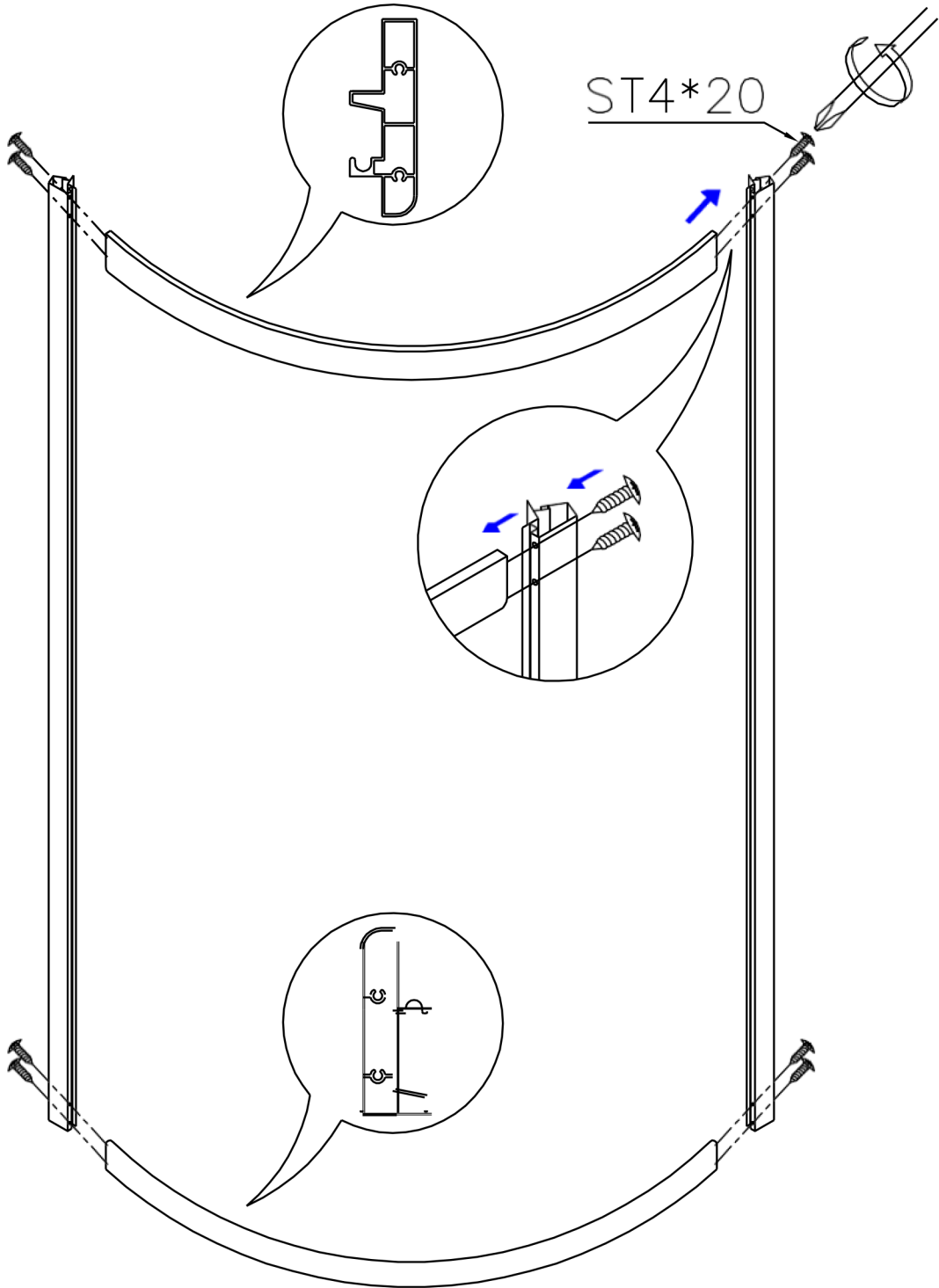
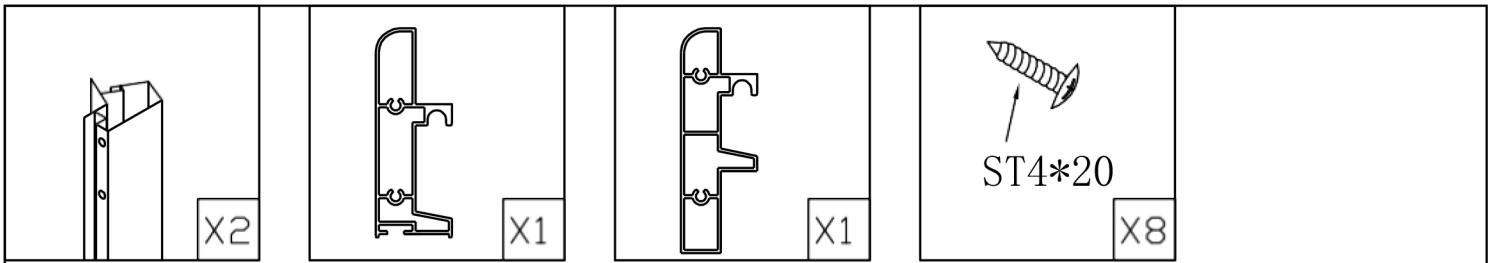

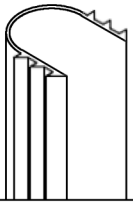

X2



X2



X2



ST4\*16

X4

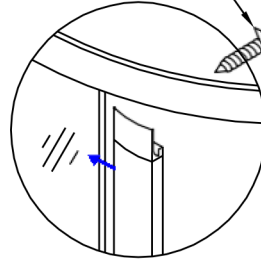
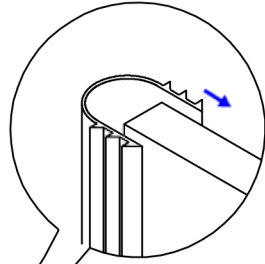

ST4\*16

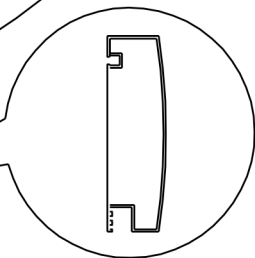
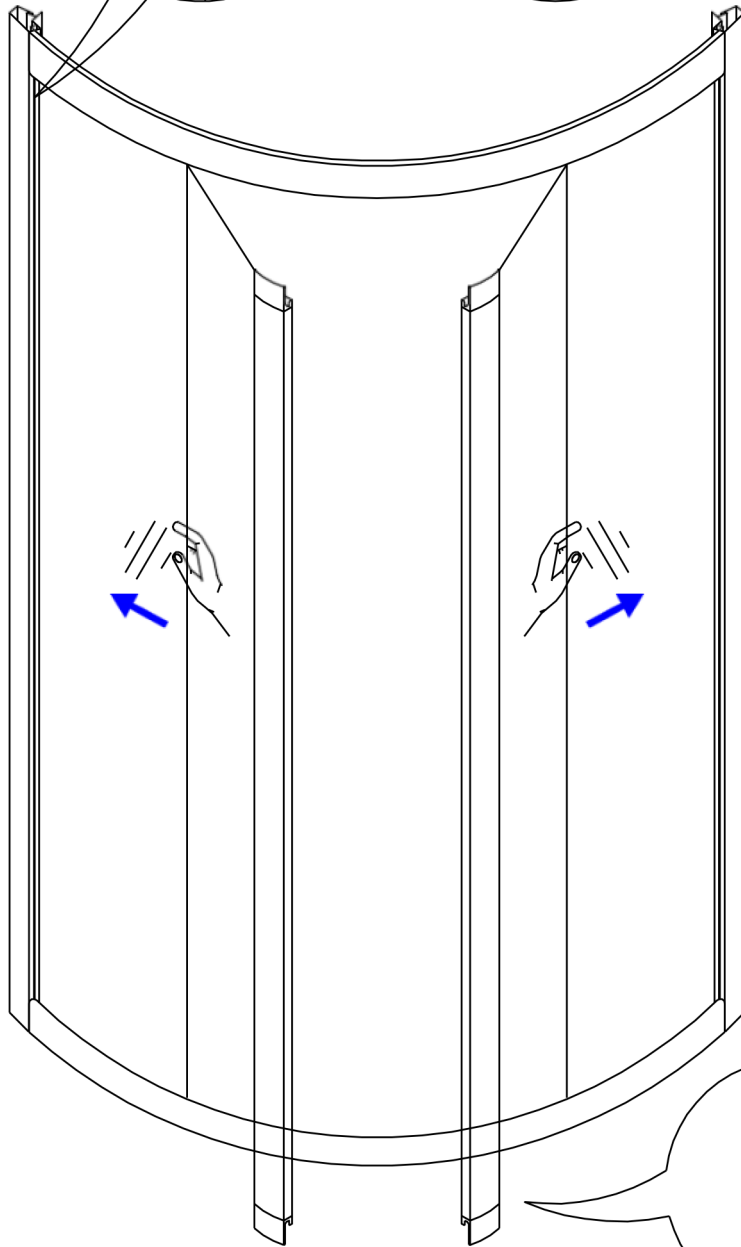

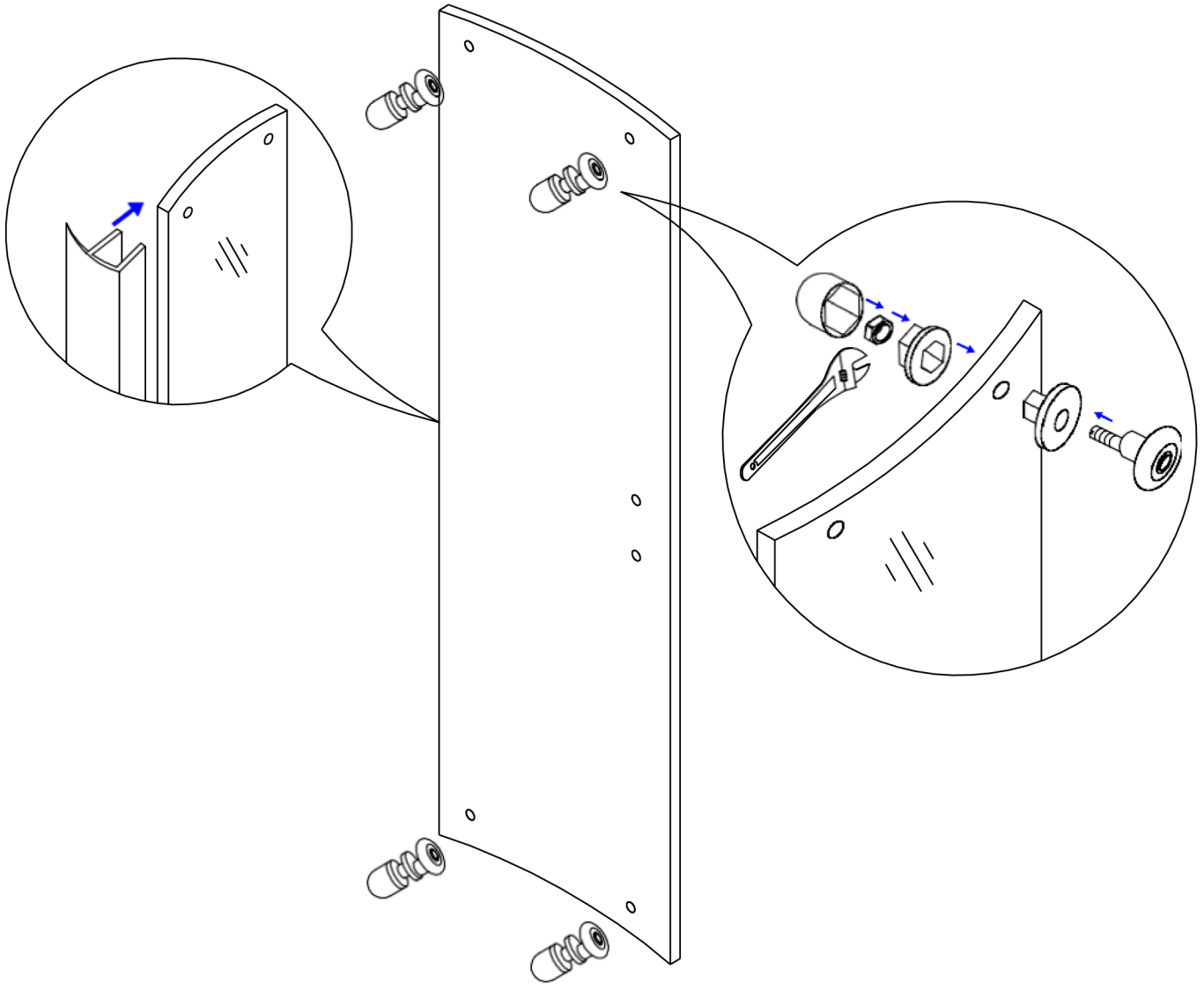
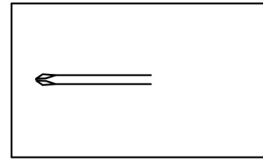
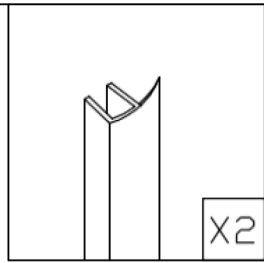
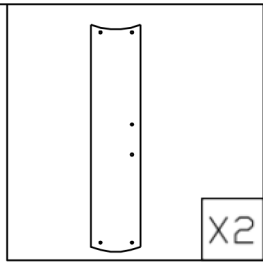
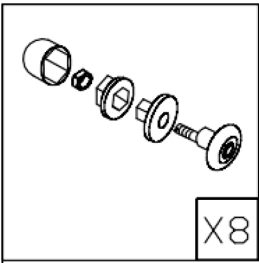



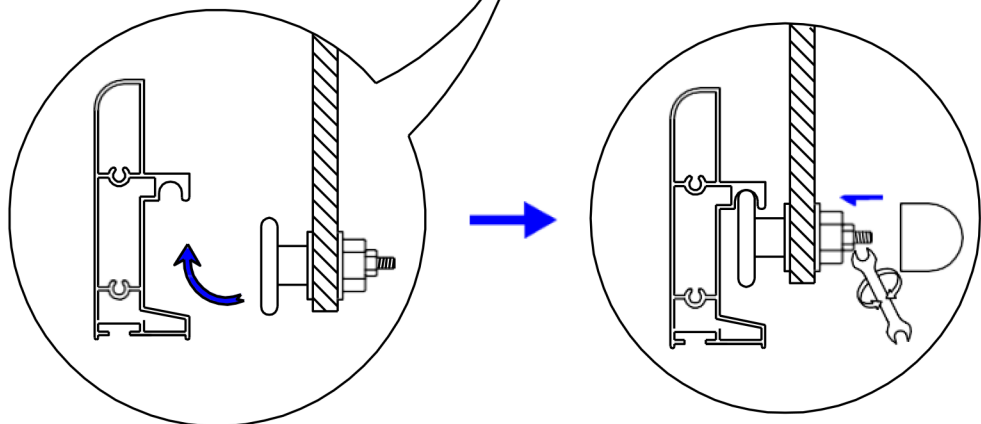
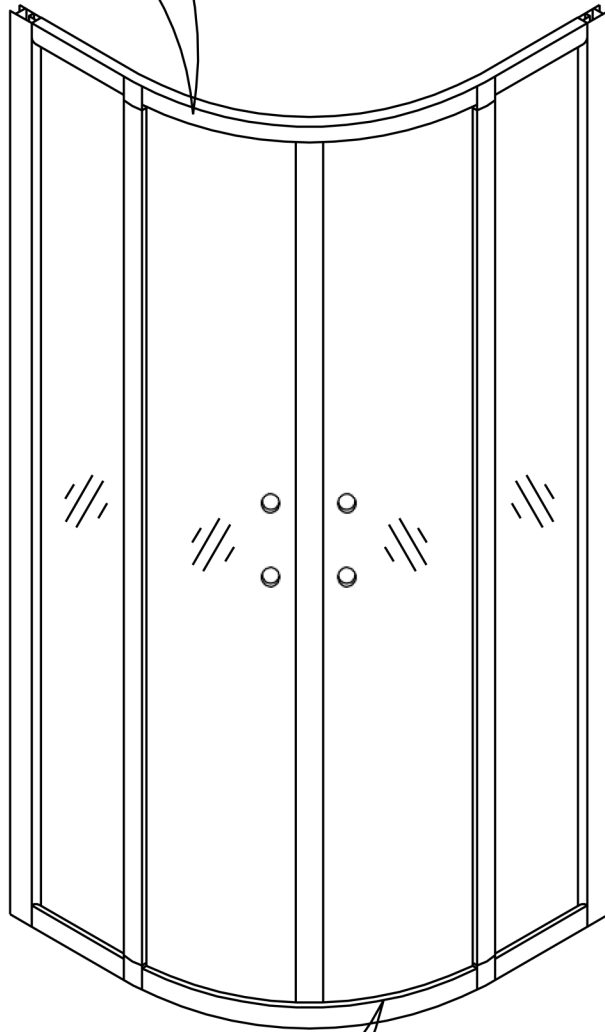
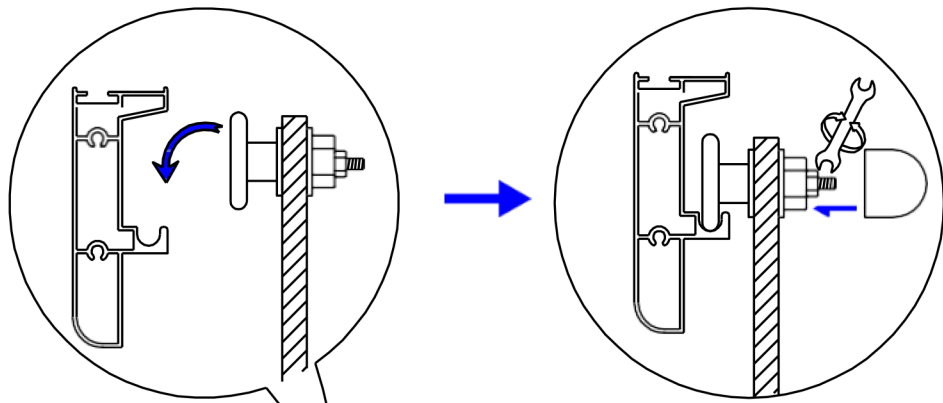

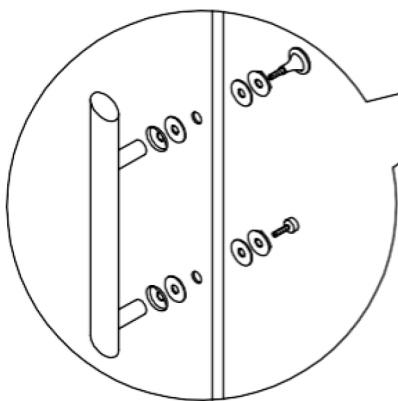
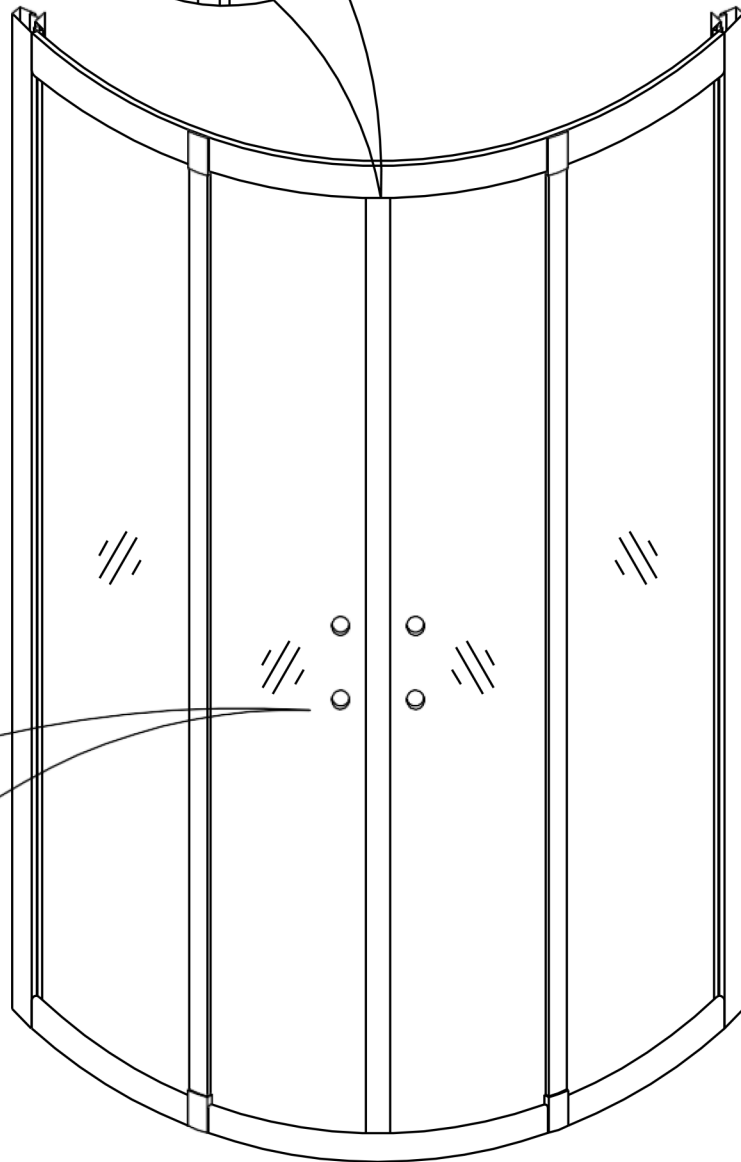
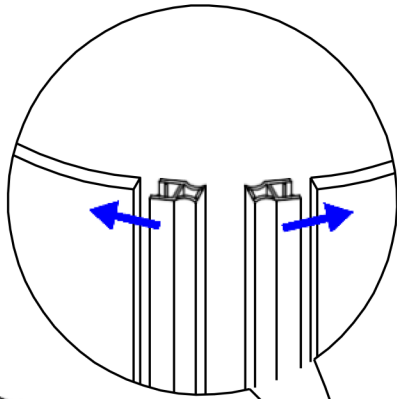
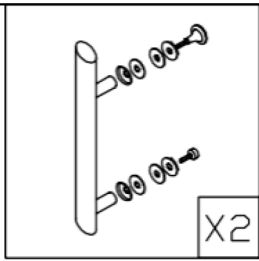
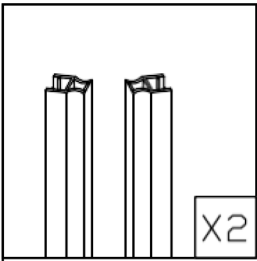

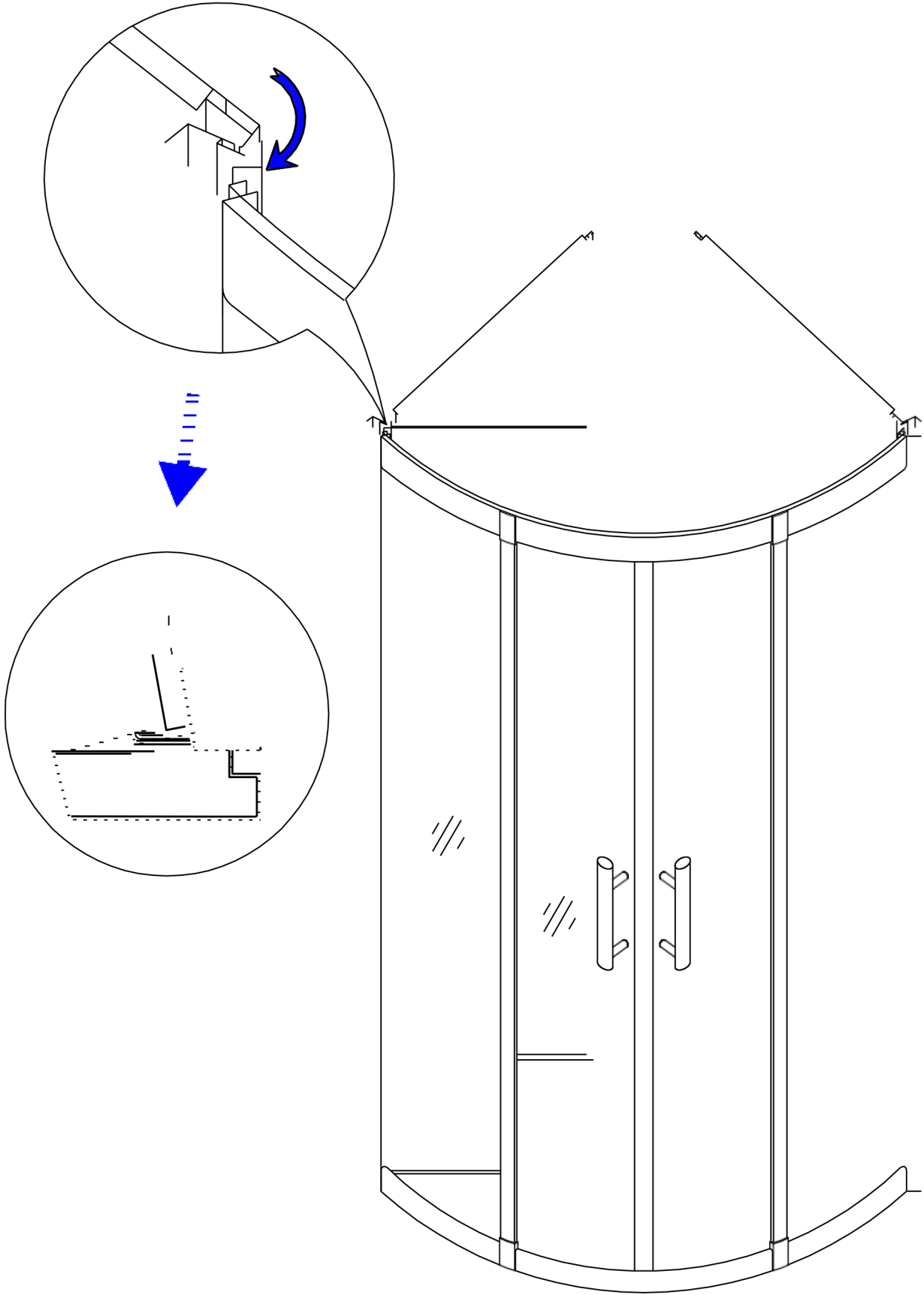

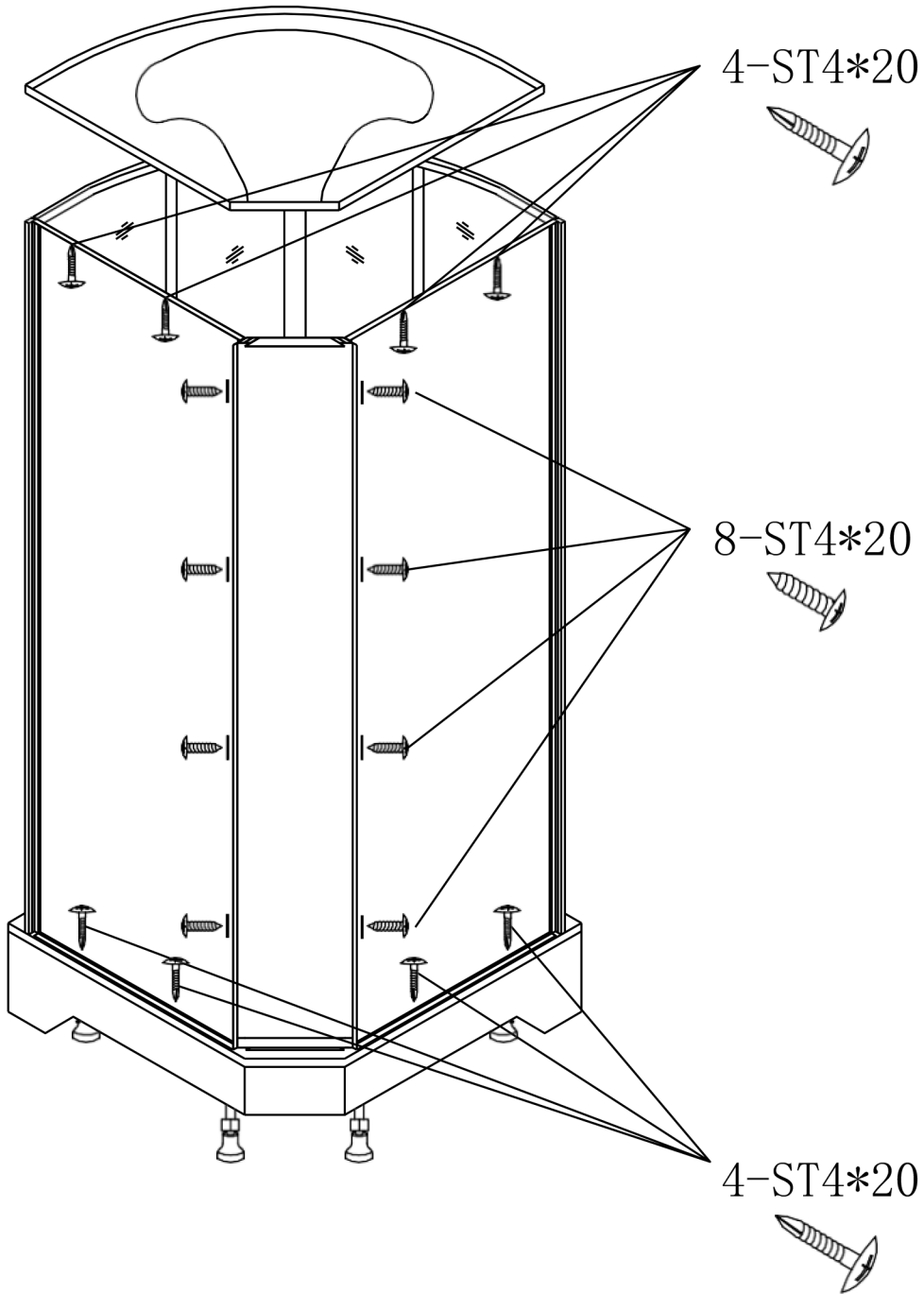
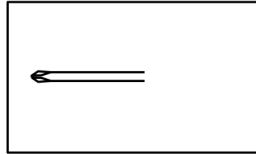
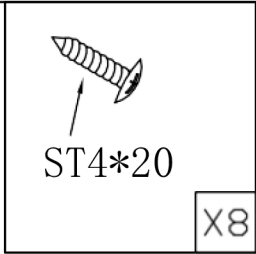
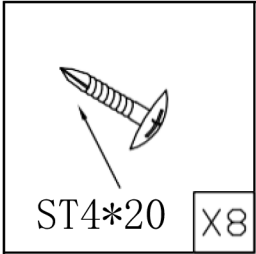

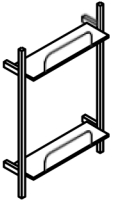

X1

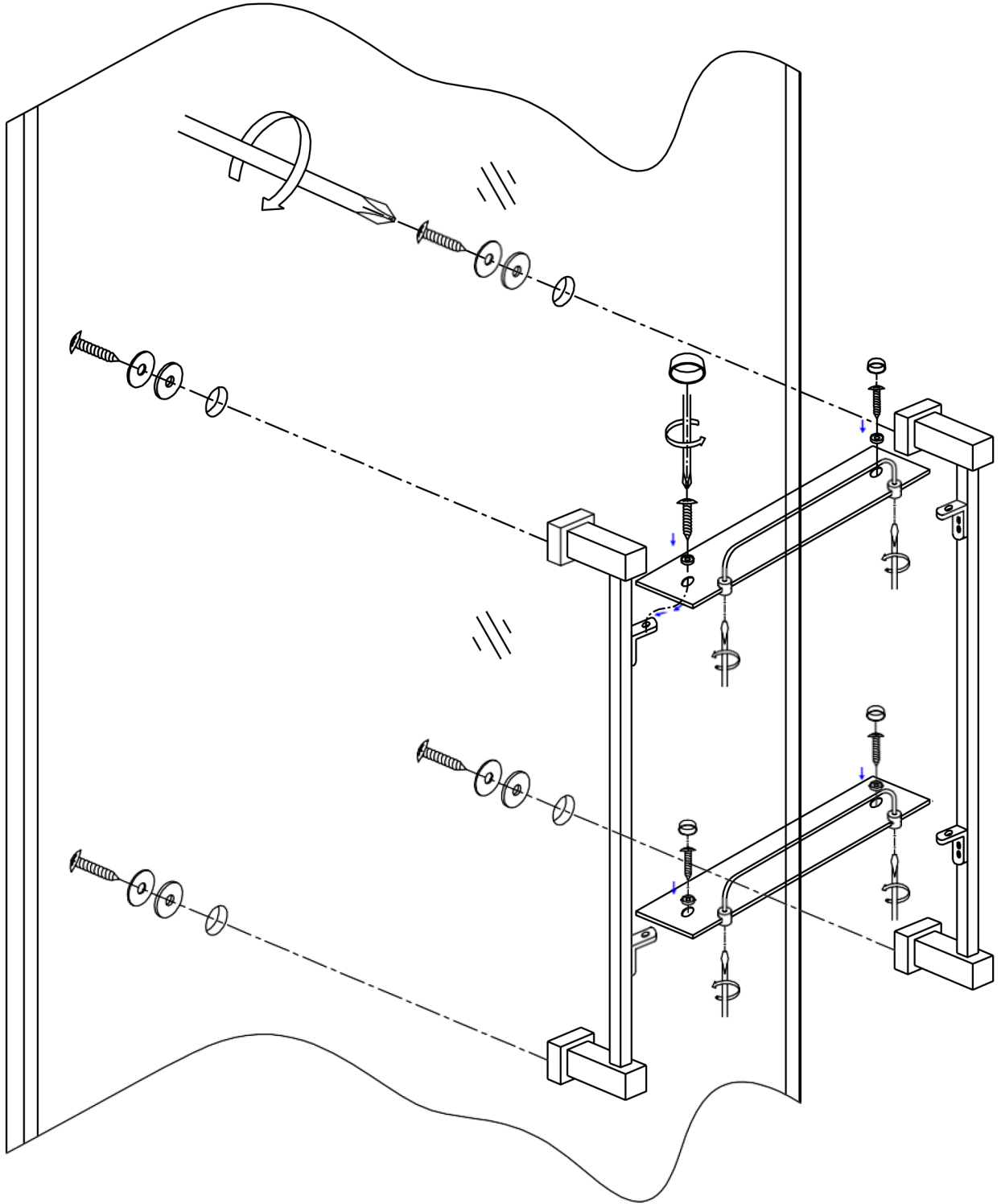
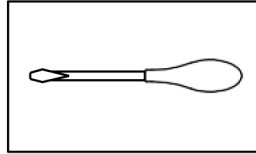
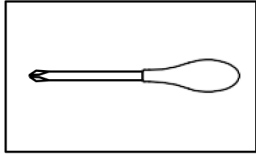



X1

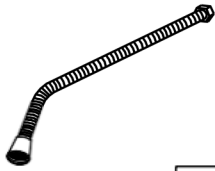

X1

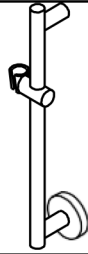

X1

