

COLLEZIONI
D' A U T O R E

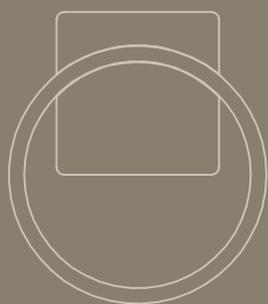

CYGNUS Q
EQB DESIGN

 **BELLOSTA**[®]
rubinetterie
rubinetti d'autore made in Italy

index

progetto su misura	2
finiture d'autore	3
fotografico	4
listino prezzi	12

COLLEZIONI D'AUTORE



manifattura completamente italiana

progetto su misura - customizing project

prodotto

Ad architetti e progettisti si vuole offrire l'opportunità di un servizio esclusivo, PROGETTO SU MISURA, personalizzando gli elementi in funzione di specifiche richieste estetiche o problematiche legate a vincoli progettuali. Oltre trenta linee, sviluppate su scala industriale si prestano ad essere modificate nelle dimensioni, nei componenti e nelle finiture per diventare la soluzione ideale in tutte le situazioni in cui è necessario uscire dagli standard.

Per informazioni e richieste PROGETTI SU MISURA: ufficiotecnico3@bellostarubinetterie.com

product

To any architects or designers we would offer an exclusive service, the PROGETTO SU MISURA, by customizing the elements in relationship at specific aesthetic request or about projection duty. The size, components and finishings of over thirty industrial scale lines can be modified to perfectly fit all those situations that demand non-standard solutions.

For informations and PROJECTS "SU MISURA" requests: ufficiotecnico3@bellostarubinetterie.com

colore

Il servizio PROGETTO SU MISURA non si limita alla personalizzazione a 360° delle componenti dimensionali del prodotto. La scelta della finitura a volte ricade sul cromato perchè è difficile trovare nei complementi di arredo la stessa tonalità. Grazie a SU MISURA COLORS è possibile ottenere lo stesso colore sia sugli articoli presenti a listino sia sui componenti non prodotti da Bellosta Rubinetterie: maniglie, cerniere wc, piedini vasca, applique, profili doccia sono solo alcuni degli elementi realizzabili nella finitura scelta.

E' possibile inviare all'ufficio tecnico i complementi che si desidera ritrattare, per poterne valutare la fattibilità.

color

The PROGETTO SU MISURA service is not limited to the 360° customization of the dimensional components of the product. The choice of finish sometimes point on the chrome because it is difficult to find the same tonality in the furnishing complements. Thanks to SU MISURA COLORS, it is possible to obtain the same color on both the faucet collection and the components not produced by Bellosta Rubinetterie: handles, hinges, bathtub legs, applique, shower profiles are just some of the elements that the company can turn into the finishing choice. It is possible to send to the technical office the complements that you would like to retract, in order to evaluate the feasibility.

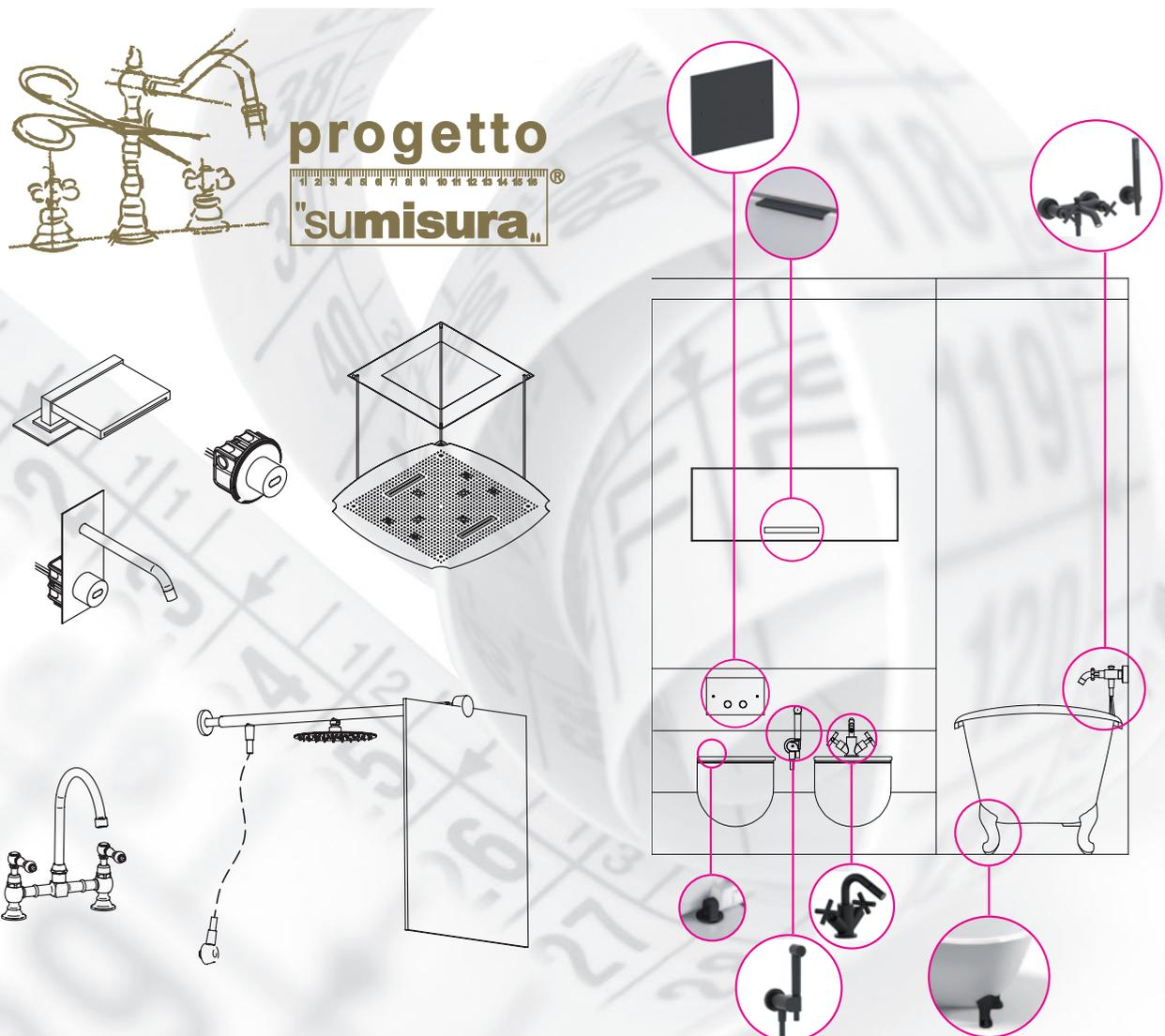

finiture d'autore - artist finishing

Anteporre il codice finitura al codice articolo. Es: **01-codice articolo** per finitura cromato.

Before the code article insert the reference finish. Ex: **01-code** for the chrome color.

 01 cromato chrome	 14 bianco white	 61 rosso red	 93 arenaria opaco matt sandstone
 02 cromo/oro chrome/gold	 19 nero black	 66 bianco opaco matt white	 94 tuscany spazzolato brushing tuscany
 03 oro/argento gold/silver	 28 nickel satinato satin nickel	 67 nero opaco matt black	 95 rame acidato etched copper
 04 dorato gold	 30 nickel lucido polished nickel	 68 rame opaco matt copper	 96 cemento opaco matt cement
 05 bronzo satinato satin bronze	 33 cromo satinato satin chrome	 69 argento opaco matt silver	 A1 brina opaco matt frost
 06 rame vecchio old copper	 34 cromo spazzolato brushing chrome	 71 oro opaco matt gold	 A2 tuscany cerato oilskin tuscany
 07 vecchio argento old silver	 35 nickel spazzolato brushing nickel	 72 bronzo opaco matt bronze	 A3 ottone acidato etched brass
 08 canna di fucile gun barrel	 56 avorio ivory	 75 dorato spazzolato brushing gold	 A4 basalto opaco matt basalt
 10 verderame verdigris	 57 azzurro light blue	 87 oro rosa pink gold	 B2 black gun metal PVD
 11 nero antracite anthracite black	 58 verdino light green	 88 ottone sisal sisal brass	 B3 nickel PVD
 12 ottone lucido polished brass	 59 marrone brown	 89 industrial industrial	 B4 matt gold PVD
 13 ottone naturale natural brass	 60 arancio orange	 92 pomice opaco matt pumice	

garanzia

Si ricorda che la Garanzia sulle finiture DECADE nel momento in cui manutenzione e pulizia NON vengano effettuate in modo adeguato e continuativo.

warranty

Please note that the Warranty on finishes DECAY when maintenance and cleaning NOT be made adequately and continuously.

Le finiture d'autore Bellosta sono il risultato dell'artigianalità della produzione italiana della nostra azienda: eventuali differenze di tonalità non sono da considerarsi difetto, ma caratteristica di unicità del prodotto. Bellosta color finishes are the resulted of an handcrafted italian production of our firm: any eventual difference of shade, are not to consider like a defect, but like a unique featuring of the product.

manutenzione e pulizia

Asciugare sempre con un panno morbido immediatamente dopo l'uso. Non utilizzare mai detersivi, agenti chimici, spugne abrasive, pagliette metalliche, alcool, che danneggerebbero irrimediabilmente le superfici del prodotto. Pulire esclusivamente con sapone neutro, abbondante acqua asciugare con panno morbido.

maintenance and cleaning

Always dry with a soft cloth immediately after use.

Never use detergents, chemicals, abrasive sponges, scouring pads, alcohol, which could cause irreparable damage to the product surfaces. Clean only with natural/fresh soap, plenty of water and dry with a soft cloth.

CYGNUS Q

DESIGN EQB



08-5105/S + 04-514010 canna di fucile / dorato
gun barrel / gold

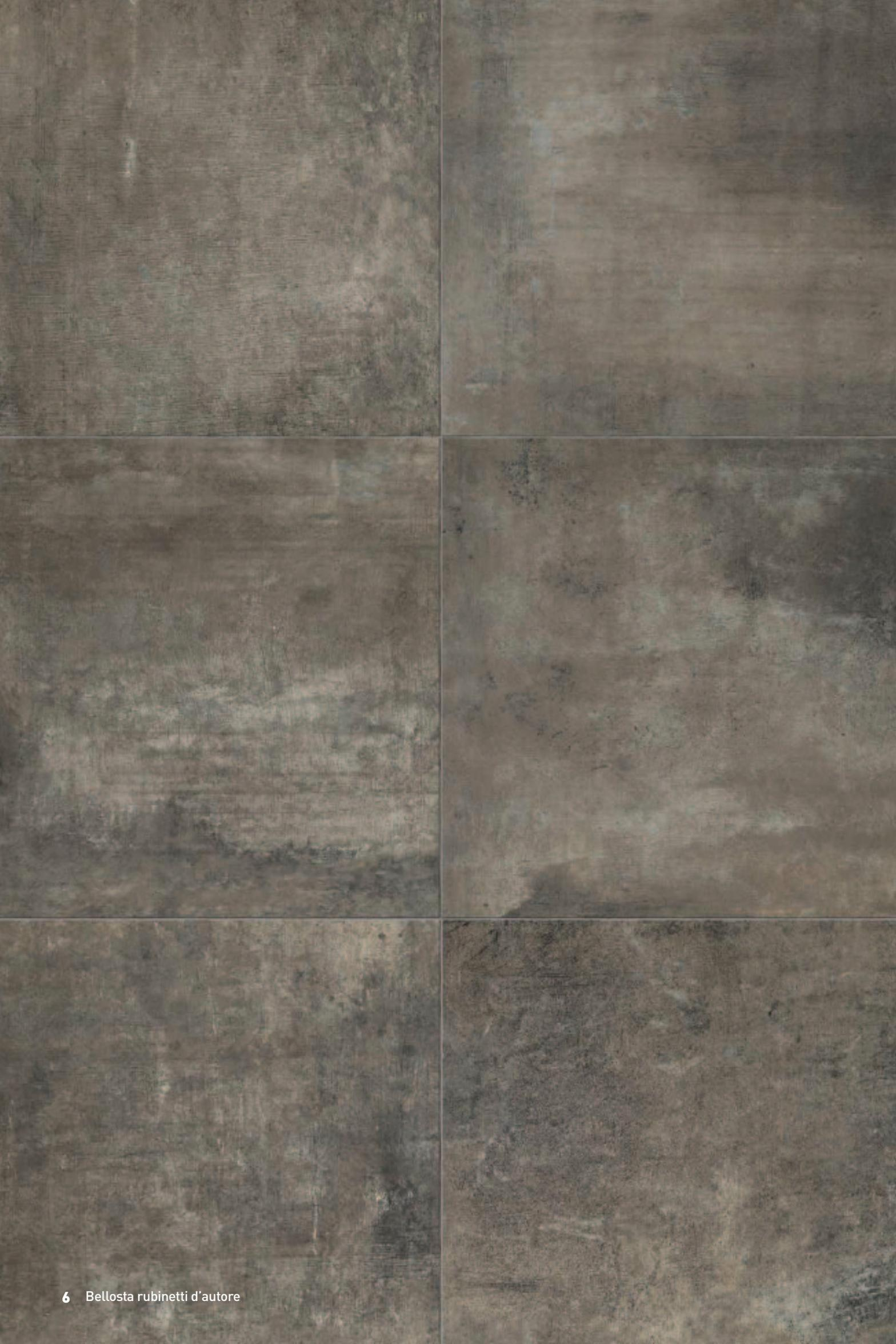



34-5105/1 + 67-514010



94-5105/3/A/E+ 94-514010 + 01-894001



01-5105/R/A + 01-514010 + 01-104033



87-5105/R/A + 87-514010



72-5107/S + 72-514010

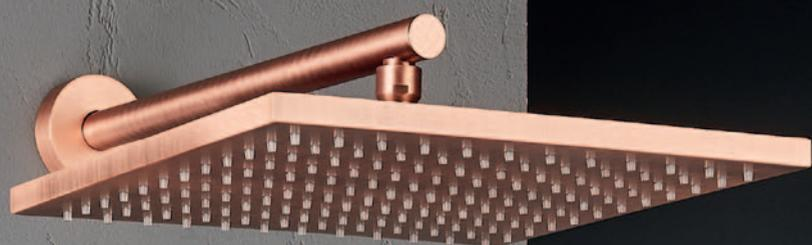

06-2212/2/P/E + 06-514016
+ 484021

06-044056
ref. REVIVRE BRACCI
06-655177
ref. REVIVRE SOFFIONI
STANDARD
06-4403/1/A
ref. REVIVRE DOCCIA
COMPLEMENTI



67-5100/E + 67-514010 + 01-104002, 67-4403/1/A, 67-8903



01-5101/A + 67-514010



92-5105/1 + 92-514010, 93-5105/S + 75-514010, A4-5105/S + 01-514010



INDICE | INDEX

INFO TECNICHE pag. 13

TABELLA PREZZI FINITURE pag. 14



CONSULTA LISTINO ON LINE
CHECK ON LINE PRICE LIST

www.bellostarubinetterie.com/online/cygnusQ.pdf

LAVABO	pag. 15/17
BIDET	pag. 17
DOCCIA INCASSO	pag. 17/18
DEVIATORI INCASSO	pag. 19
DOCCIA INCASSO TERMOSTATICO	pag. 19/20
DOCCIA ESTERNO	pag. 21
DOCCIA COMPLEMENTI	pag. 21
SOFFIONI/BRACCI	pag. 21
COMPONI SET DOCCIA	pag. 21
VASCA	pag. 22
BAGNO COMPLEMENTI	pag. 22/23

FORATURA DEI PIANI SANITARI

I miscelatori lavabo/bidet monoforo prevedono un foro di diametro 35 mm nel piano sanitario.

MONOFORO >>

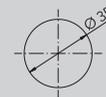

DRILLING PLANS HEALTH

The sink / hole bidet mixers provide a hole diameter of 35 mm in the health plan.

INSTALLAZIONE LAVABI A MURO

Distanza verticale consigliata tra l'uscita dell'acqua ed il bordo superiore del lavabo 8÷10 cm.

WALL-MOUNTED WASHBASIN INSTALLATION

Recommended vertical distance between the water outlet and the upper edge of the sink 8÷10 cm.

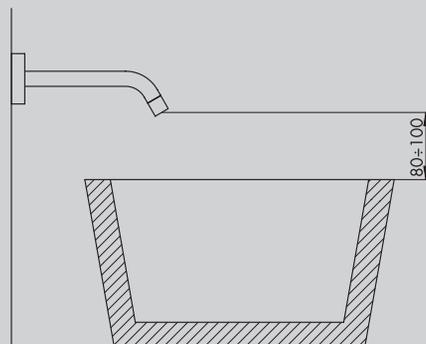

SCHEMA FUNZIONAMENTO DEVIATORI INCASSO 2/3/4 USCITE

Questi deviatori non hanno funzione di chiusura. Ruotando verso destra o sinistra si attivano le uscite. Tra 2 uscite adiacenti durante la rotazione diminuisce la portata dell'uscita iniziale ed incrementa quella della successiva. In posizione intermedia sono entrambe attive a pari portata.

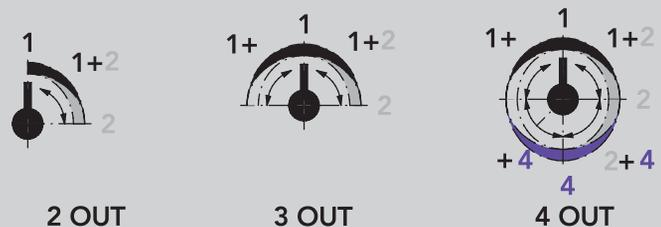

SCHEME OPERATION SWITCHES FLUSH OUTPUT 2/3/4

These diverters have not closing function. By turning to the right or left activates the outputs. Between two adjacent outputs during the rotation decreases the initial output flow and increases that of the next. In position intermediate are both active at the same flow rate.

SCHEMA FUNZIONAMENTO MISCELATORI TERMOSTATICI 2/3/4 USCITE

Leva in posizione ore 12 = deviatore chiuso. Ruotando verso destra o sinistra si attivano le diverse uscite. Partendo dalla posizione di STOP, durante la rotazione la portata dell'acqua si incrementa verso la posizione successiva. Tra 2 uscite adiacenti durante la rotazione diminuisce la portata dell'uscita iniziale ed incrementa quella della successiva. In posizione intermedia sono entrambe attive a pari portata.



SCHEME OPERATING THERMOSTATIC MIXER 2/3/4 OUT

Lever to the 12 o'clock position = switch closed. Turning left or right. They activate different outputs. Starting from the STOP position, while rotation of the water flow rate between two adjacent outputs is increased towards the next position. Between two adjacent outputs during the rotation decreases the initial output flow and increases that of the next. In position intermediate are both active at the same flow rate.

CONSIGLIO TECNICO

Tutti i miscelatori della collezione CYGNUS Q vengono collaudati nel loro funzionamento al momento dell'assemblaggio. Per garantire la durata delle cartucce nel tempo, si consiglia di spurgare bene l'impianto idraulico prima del montaggio (per rimuovere eventuali detriti) e di installare rubinetti sottolavabo con filtro (art. 020).

N.B.: Qualora il piano lavabo avesse uno spessore superiore a 4 cm specificare la misura al momento dell'ordine.

TECHNICAL ADVICE

All mixers of the CYGNUS Q collection are perfectly tested. To guarantee the perfect functionality of the cartridge for a long time, we advise to clean the sanitary plant before installing the mixer. Moreover we advise to install angle valve with filter (art. 020).

Attention: If the lavatory top is more than cm 4 thick, please point it out when placing the order.

PROGETTO SU MISURA: RICHIESTE SPECIALI

I tecnici di Bellosta Rubinetterie sono, inoltre, a disposizione di architetti e designers, per offrire un servizio esclusivo: personalizzazioni di elementi in funzione di specifiche richieste estetiche o problematiche legate a vincoli progettuali, verifica della fattibilità attraverso opportuni studi CAD e sviluppo del disegno tecnico del prodotto speciale richiesto.

Per informazioni e richieste PROGETTI SU MISURA:

ufficiotecnico@bellostarubinetterie.com

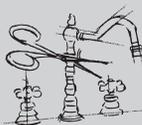

progetto
"sumisura"

PROGETTO SU MISURA: SPECIAL REQUESTS

Engineers Bellosta Rubinetterie are also available to architects and designers, to offer an exclusive service: customizations of items according to specific aesthetic requirements or issues related to design constraints, verification of the feasibility studies and development through appropriate CAD technical design the required special product. For information and requests "SU MISURA" PROJECTS:

ufficiotecnico@bellostarubinetterie.com

PREZZO FINITURE

Calcola il prezzo di listino (IVA esclusa) delle finiture diverse dal cromato, consultando la seguente tabella.

Moltiplicare il **PREZZO LISTINO** per il **COEFFICIENTE MOLTIPLICATORE** della finitura scelta, arrotondando per difetto il prezzo ottenuto (eliminare i centesimi). **ESEMPIO** per ordinare art. 5105/S in finitura dorato con anello maniglia nero opaco: codice 04-5105/S + 67-514010

COMPOSIZIONE CODICE PER ORDINARE ARTICOLO IN FINITURA

XX - **5105/S**

CODICE FINITURA FINISH CODE CODICE ARTICOLO ITEM NUMBER +

XX - **514010**

CODICE FINITURA FINISH CODE CODICE ANELLO MANIGLIA HANDLE RING NUMBER

PRICE FINISHES

Include the list price (excluding VAT) of different finishes from chrome, consulting the following table. **Multiply the PRICE LIST MULTIPLIER COEFFICIENT** of the chosen finish, reducing the price obtained by deleting the centesim. **EXAMPLE** to order art. 5105/S gold finish with matt black handle ring: code 04-5105/S + 67-514010

**MOLTIPLICATORI FINITURE DI SERIE
STANDARD FINISHES MULTIPLIERS**

COD. CODE	DESCRIZIONE FINITURA FINISH DESCRIPTION	CYGNUS Q	RICAMBI	ACCES-SORI	DOCCIA COMPL.
01-	cromato/chrome	PREZZO LISTINO°			

**MOLTIPLICATORI FINITURE A RICHIESTA
ON REQUEST FINISHES MULTIPLIERS**

COD. CODE	DESCRIZIONE FINITURA FINISH DESCRIPTION	CYGNUS Q	RICAMBI	ACCES-SORI	DOCCIA COMPL.
02-	cromo/oro/chrome/gold				
03-	oro/argento/gold/silver				
04-	dorato/gold				
05-	bronzo satinato/satin bronze				
06-	rame vecchio/old copper				
07-	vecchio argento/old silver				
08-	canna di fucile/gun barrel				
10-	verderame/verdigris				
11-	nero antracite/anthracite black				
12-	ottone lucido/polished brass				
13-	ottone naturale/natural brass				
14-	bianco lucido/glossy white				
19-	nero lucido/glossy black				
28-	nickel satinato/satin nickel				
30-	nickel lucido/polished nickel				
33-	cromo satinato/satin chrome				
34-	cromo spazzolato/brushing chrome				
35-	nickel spazzolato/brushing nickel				
56-	avorio/ivory				
57-	azzurro/light blue				
58-	verdino/light green				

**MOLTIPLICATORI FINITURE A RICHIESTA
ON REQUEST FINISHES MULTIPLIERS**

COD. CODE	DESCRIZIONE FINITURA FINISH DESCRIPTION	CYGNUS Q	RICAMBI	ACCES-SORI	DOCCIA COMPL.
59-	marrone/brown				
60-	arancio/orange				
61-	rosso/red				
66-	bianco opaco/mat white				
67-	nero opaco/matt black				
68-	rame opaco/matt copper				
69-	argento opaco/matt silver				
71-	oro opaco/matt gold				
72-	bronzo opaco/matt bronze				
75-	dorato spazzolato/brushing gold				
87-	oro rosa/pink gold				
88-	ottone sisal/sisal brass				
89-	industrial				
92-	pomice opaco/matt pumice				
93-	arenaria opaco/matt sandstone				
94-	tuscany spazzolato/brushing tuscany				
95-	rame acidato/etched copper				
96-	cemento opaco/matt cement				
A1-	brina opaco/matt frost				
A2-	tuscany cerato/oilskin tuscany				
A3-	ottone acidato/etched brass				
A4-	basalto opaco/matt basalt				
B2-	black gun metal PVD				
B3-	nickel PVD				
B4-	matt gold PVD				

NOTE:

art. 915003 realizzabile nelle seguenti finiture: 01,03,04,05,06,07,12,13,19,28,30,33,34,35,66,67,68,69,71,72,75,B2,B3,B4. Per altre finiture ordinare art. 655016 (prezzo di listino cromato € 40,00) Per art. 8816/E utilizzare moltiplicatori DOCCIA COMPLEMENTI.

NOTE:

The art. 915003 si available in the following finishes: 01,03,04,05,06,07,12,13,19,28,30,33,34,35,66,67,68,69,71,72,75,B2,B3,B4. For other colors order the art. 655016 (chrome price-list € 40,00) For art. 8816/E use multipliers of DOCCIA COMPLEMENTI collection.

ATTENZIONE! 13-OTTONE NATURALE e 88-OTTONE SISAL: finiture non protette che antichizzano naturalmente ossidando a contatto con l'umidità atmosferica. **WARNING! 13-NATURAL BRASS and 88-SISAL BRASS:** unprotected finishes that naturally oxidise in contact with atmospheric humidity.

RICHI. = PREZZO A RICHIESTA ON REQUEST PRICE DOCCIA COMPLEMENTI SHOWER COMPLEMENTS

* N.R. = NON REALIZZABILE NOT MADE ACCESSORI ACCESSORIES

°PREZZO DI LISTINO PRICE LIST RICAMBI SPARE PARTS

5105/S + 514010

[mix] [anello]

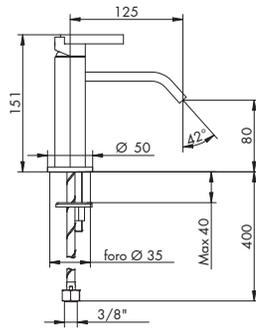
MISCELATORE LAVABO MONOFORO
BASIN MIXER

- > cartuccia tradizionale
- > interasse bocca 125
- > flessibili di alimentazione
- > senza scarico



CROMATO / MAN. CROMATO

01-5105/S	€
01-514010	€

PREZZO TOTALE €

CROMATO / MANIGLIA IN ALTRA FINITURA

01-5105/S	€
XX-514010	€ x M*

ALTRE FINITURE

XX-5105/S	€	x M*
XX-514010	€	x M*



5105/P/S + 514010

[mix] [anello]

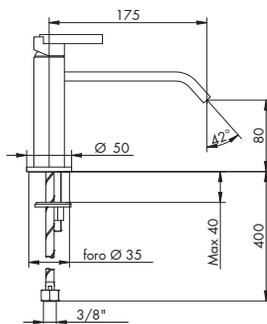
MISCELATORE LAVABO MONOFORO BOCCA PROLUNGATA
BASIN MIXER EXTENDED SPOUT

- > cartuccia tradizionale
- > interasse bocca 175
- > flessibili di alimentazione
- > senza scarico



CROMATO / MAN. CROMATO

01-5105/P/S	€
01-514010	€

PREZZO TOTALE €

CROMATO / MANIGLIA IN ALTRA FINITURA

01-5105/P/S	€
XX-514010	€ x M*

ALTRE FINITURE

XX-5105/P/S	€	x M*
XX-514010	€	x M*

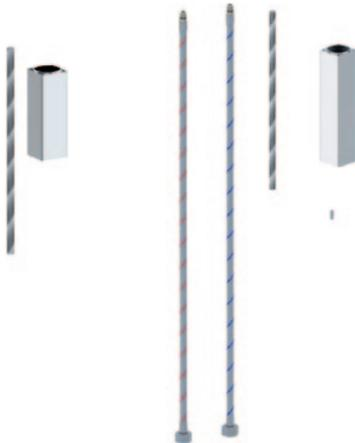

514014 | 514015

PROLUNGHE MISCELATORE LAVABO
EXTENSIONS FOR BASIN

- > altezza 100 mm, 150 mm

CROMATO

01-514014	100 mm	€
01-514015	150 mm	€

PREZZO TOTALE €

ALTRE FINITURE

XX-514014	100 mm	€	x M*
XX-514015	150 mm	€	x M*

5105/1 + 514010

[mix] [anello]

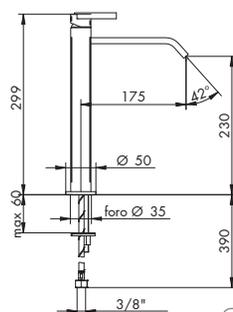
MISCELATORE LAVABO MONOFORO ALTO BOCCA PROLUNGATA
HIGHER BASIN MIXER EXTENDED SPOUT

- > cartuccia tradizionale
- > interasse bocca 175
- > flessibili di alimentazione
- > senza scarico



CROMATO / MAN. CROMATO

01-5105/1	€
01-514010	€

PREZZO TOTALE €

CROMATO / MANIGLIA IN ALTRA FINITURA

01-5105/1	€
XX-514010	€ x M*

ALTRE FINITURE

XX-5105/1	€	x M*
XX-514010	€	x M*



5105/3/A/E + 514010 + 894001

[parte esterna] [anello] [parte incasso]

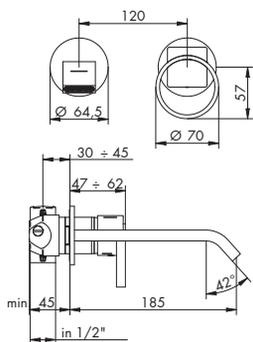

MISCELATORE LAVABO DA PARETE BOCCA PROLUNGATA
WALL BASIN EXTENDED SPOUT MIXER

- > cartuccia tradizionale
- > interasse bocca 185
- > ingressi da 1/2"
- > senza scarico
- > rosoni separati

SCARICO LAVABO
BASIN WASTE
0136/U
cromato € 63,00

SIFONE
SIPHON
0133/L
cromato € 164,00

P. EST. - CROMATO / MAN. CROMATO

01-5105/3/A/E	€
01-514010	€

PARTE INCASSO

01-894001	€
-----------	---

PREZZO TOTALE €

P. EST. - CROMATO / MAN. IN ALTRA FINITURA

01-5105/3/A/E	€	
XX-514010	€	x M*

PARTI ESTERNE - ALTRE FINITURE

XX-5105/3/A/E	€	x M*
XX-514010	€	x M*

CORPO MANIGLIA
HANDLE BODY
514012

ROSONE BOCCA
SPOUT ROSE
WINDOW
724039

ROSONE MIX
MIXER ROSE
WINDOW
894013

AERATORE C/CHIAVE
AERATOR W/KEY
795004

CARTUCCIA
CARTRIDGE
025002

5105/3/B/E + 514010 + 894001

[parte esterna] [anello] [parte incasso]

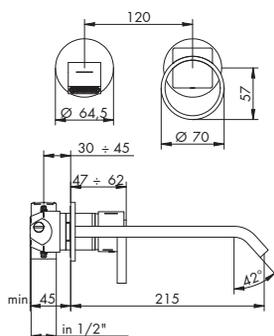

MISCELATORE LAVABO DA PARETE BOCCA EXTRA PROLUNGATA
WALL BASIN EXTRA EXTENDED SPOUT MIXER

- > cartuccia tradizionale
- > interasse bocca 215
- > ingressi da 1/2"
- > senza scarico
- > rosoni separati

SCARICO LAVABO
BASIN WASTE
0136/U
cromato € 63,00

SIFONE
SIPHON
0133/L
cromato € 164,00

P. EST. - CROMATO / MAN. CROMATO

01-5105/3/B/E	€
01-514010	€

PARTE INCASSO

01-894001	€
-----------	---

PREZZO TOTALE €

P. EST. - CROMATO / MAN. IN ALTRA FINITURA

01-5105/3/B/E	€	
XX-514010	€	x M*

PARTI ESTERNE - ALTRE FINITURE

XX-5105/3/B/E	€	x M*
XX-514010	€	x M*

CORPO MANIGLIA
HANDLE BODY
514012

ROSONE BOCCA
SPOUT ROSE
WINDOW
724039

ROSONE MIX
MIXER ROSE
WINDOW
894013

AERATORE C/CHIAVE
AERATOR W/KEY
795004

CARTUCCIA
CARTRIDGE
025002

5105/R/A + 514010

[mix] [anello]

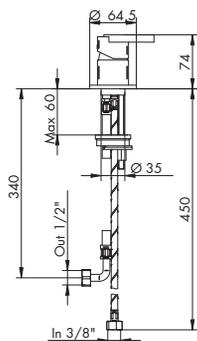

MISCELATORE REMOTO
REMOTE MIXER

- > cartuccia tradizionale
- > flessibili di alimentazione
- > senza scarico

SCARICO LAVABO
BASIN WASTE
0136/U
cromato € 63,00

SIFONE
SIPHON
0133/L
cromato € 164,00

CROMATO / MAN. CROMATO

01-5105/R/A	€
01-514010	€

PREZZO TOTALE €

CROMATO / MANIGLIA IN ALTRA FINITURA

01-5105/R/A	€	
XX-514010	€	x M*

ALTRE FINITURE

XX-5105/R/A	€	x M*
XX-514010	€	x M*

CORPO MANIGLIA
HANDLE BODY
514011

SET FLESSIBILI
SET HOSES
444013

BASETTA
BASE
514019

CARTUCCIA
CARTRIDGE
025002

5105/R/B/E + 514010 + 104033

[parte esterna] [anello] [parte incasso]

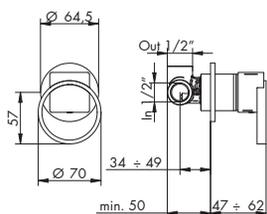

MISCELATORE INCASSO REMOTO
BUILT-IN REMOTE MIXER

- > cartuccia tradizionale
- > ingressi da 1/2"
- > uscita superiore
- > senza scarico
- > utilizzabile anche come incasso doccia

SCARICO LAVABO
BASIN WASTE
0136/U
cromato € 63,00

SIFONE
SIPHON
0133/L
cromato € 164,00

P. EST. - CROMATO / MAN. CROMATO

01-5105/R/B/E	€
01-514010	€

PARTE INCASSO

01-104033	€
-----------	---

PREZZO TOTALE €

P. EST. - CROMATO / MAN. IN ALTRA FINITURA

01-5105/R/B/E	€	
XX-514010	€	x M*

PARTI ESTERNE - ALTRE FINITURE

XX-5105/R/B/E	€	x M*
XX-514010	€	x M*

CORPO MANIGLIA
HANDLE BODY
514012

ROSONE MIX
MIXER ROSE
WINDOW
894013

CARTUCCIA
CARTRIDGE
025002

104009 | 104010 | 104011

KIT PROLUNGA MIX INCASSO
BUILT-IN MIXER EXTENSION KIT

- > lunghezza 2 cm, 3 cm, 4 cm
- > kit fondello prolunga cartuccia miscelatore + bicchiere esterno sostitutivo in finitura
- > per art. 5105/3/A/E, 5105/3/B/E, 5105/R/B/E



CROMATO		
01-104009	2 cm	€
01-104010	3 cm	€
01-104011	4 cm	€

ALTRE FINITURE			
XX-104009	2 cm	€	x M*
XX-104010	3 cm	€	x M*
XX-104011	4 cm	€	x M*

514017 | 514018

BOCCA LAVABO DA PARETE
WALL BASIN SPOUT

- > interasse bocca 185 / 215 mm
- > attacco da 1/2"

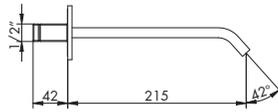
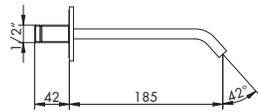
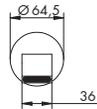

CROMATO		
01-514017	185 mm	€
01-514018	215 mm	€

ALTRE FINITURE			
XX-514017	185 mm	€	x M*
XX-514018	215 mm	€	x M*



5107/S + 514010

[mix] [anello]

MISCELATORE BIDET MONOFORO
BIDET MIXER

- > cartuccia tradizionale
- > interasse bocca 110
- > aeratore snodato
- > flessibili di alimentazione
- > senza scarico

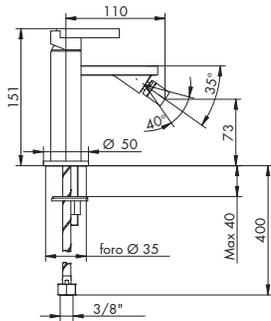

CROMATO / MAN. CROMATO	
01-5107/S	€
01-514010	€

CROMATO / MANIGLIA IN ALTRA FINITURA	
01-5107/S	€
XX-514010	€ x M*

PREZZO TOTALE €

ALTRE FINITURE	
XX-5107/S	€ x M*
XX-514010	€ x M*



5121/E + 514010 + 104018

[parte esterna] [anello] [parte incasso]

MISCELATORE INCASSO
BUILT-IN MIXER

- > cartuccia tradizionale
- > ingressi da 1/2"
- > uscita superiore
- > incasso con B-BOX

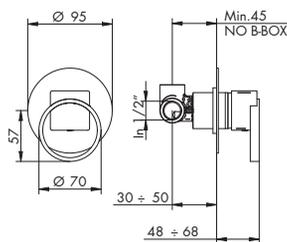

P. EST. - CROMATO / MAN. CROMATO	
01-5121/E	€
01-514010	€

P. EST. - CROMATO / MAN. IN ALTRA FINITURA	
01-5121/E	€
XX-514010	€ x M*

PARTE INCASSO

01-104018 €

PREZZO TOTALE €

PARTI ESTERNE - ALTRE FINITURE

XX-5121/E € x M*

XX-514010 € x M*



104009 | 104010 | 104011



KIT PROLUNGA MIX INCASSO
BUILT-IN MIXER EXTENSION KIT

- > lunghezza 2 cm, 3 cm, 4 cm
- > kit fondello prolunga cartuccia miscelatore + bicchiere esterno sostitutivo in finitura
- > per art.: 5121/E

CROMATO			ALTRE FINITURE		
01-104009	2 cm	€	XX-104009	2 cm	€ x M*
01-104010	3 cm	€	XX-104010	3 cm	€ x M*
01-104011	4 cm	€	XX-104011	4 cm	€ x M*

5100/E + 514010 + 104002

[parte esterna] [anello] [parte incasso]

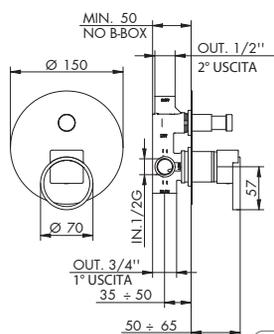

MISCELATORE INCASSO C/DEVIATORE AUTOMATICO 2 USCITE
BUILT-IN MIXER WITH AUTOMATIC DIVERTER 2 OUT

- > cartuccia tradizionale
- > deviatore a pressione 2 uscite c/ritorno automatico e blocco meccanico basse pressioni
- > attacchi da 1/2"
- > uscita principale inferiore da 3/4"
- > incasso con B-BOX



8816/E + 775025
cromato € 20,00 + 23,00

P. EST. - CROMATO / MAN. CROMATO		P. EST. - CROMATO / MAN. IN ALTRA FINITURA	
01-5100/E	€	01-5100/E	€
01-514010	€	XX-514010	€ x M*

PARTE INCASSO		PARTI ESTERNE - ALTRE FINITURE	
01-104002	€	XX-5100/E	€ x M*
PREZZO TOTALE	€	XX-514010	€ x M*



5100/1/P/E + 514010 + 724027

[parte esterna] [anello] [parte incasso]

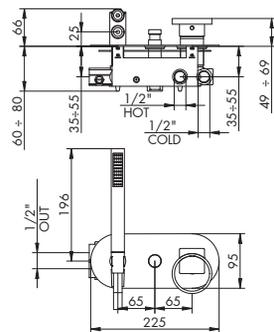

MISCELATORE INCASSO C/DEVIATORE AUTOMATICO E DOCCETTA
BUILT-IN MIXER WITH AUTOMATIC DIVERTER AND HAND SHOWER

- > cartuccia tradizionale
- > deviatore a pressione 2 uscite c/ritorno automatico e blocco meccanico basse pressioni
- > ingressi da 1/2" > uscita principale fianco sinistro
- > flessibile PVC
- > doccetta monogetto cilindrica in ABS c/anticalcare, per finiture diverse da cromo doccetta in metallo



8816/E + 775025
cromato € 20,00 + 23,00

P. EST. - CROMATO / MAN. CROMATO		P. EST. - CROMATO / MAN. IN ALTRA FINITURA	
01-5100/1/P/E	€	01-5100/1/P/E	€
01-514010	€	XX-514010	€ x M*

PARTE INCASSO		PARTI ESTERNE - ALTRE FINITURE	
01-724027	info pag. 36 €	XX-5100/1/P/E	€ x M*
PREZZO TOTALE	€	XX-514010	€ x M*

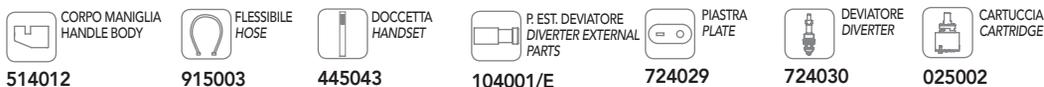

104006 | 104007 | 104008



KIT PROLUNGA MIX INCASSO CON DEVIAZIONE
BUILT-IN MIXER EXTENSION KIT WITH DIVERTER

- > lunghezza 2 cm, 3 cm, 4 cm
- > kit fondello prolunga cartuccia miscelatore e albero deviatore + bicchieri esterni sostitutivi in finitura
- > per art.: 5100/E, 5100/1/P/E

CROMATO			ALTRE FINITURE		
01-104006	2 cm	€	XX-104006	2 cm	€ x M*
01-104007	3 cm	€	XX-104007	3 cm	€ x M*
01-104008	4 cm	€	XX-104008	4 cm	€ x M*

5103/2/1E + 514010 + 914016

[parte esterna] [anello] [parte incasso]

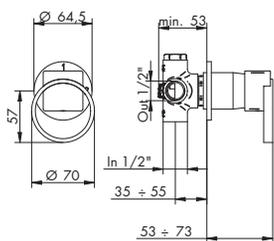

DEVIATORE INCASSO 2 USCITE
BUILT-IN DIVERTER 2 OUT

> deviatore a dischi ceramici 2 uscite senza chiusura
> attacchi da 1/2"
> abbinare a miscelatore o rubinetti d'arresto

P. EST. - CROMATO / MAN. CROMATO	
01-5103/2/1E	€
01-514010	€
PARTE INCASSO	
914016	€
PREZZO TOTALE	€

P. EST. - CROMATO / MAN. IN ALTRA FINITURA	
01-5103/2/1E	€
XX-514010	€ x M*
PARTI ESTERNE - ALTRE FINITURE	
XX-5103/2/1E	€ x M*
XX-514010	€ x M*



5103/3/1E + 514010 + 034127

[parte esterna] [anello] [parte incasso]

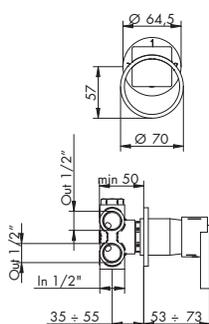

DEVIATORE INCASSO 3 USCITE
BUILT-IN DIVERTER 3 OUT

> deviatore a dischi ceramici 3 uscite senza chiusura
> attacchi da 1/2"
> abbinare a miscelatore o rubinetti d'arresto

P. EST. - CROMATO / MAN. CROMATO	
01-5103/3/1E	€
01-514010	€
PARTE INCASSO	
034127	€
PREZZO TOTALE	€

P. EST. - CROMATO / MAN. IN ALTRA FINITURA	
01-5103/3/1E	€
XX-514010	€ x M*
PARTI ESTERNE - ALTRE FINITURE	
XX-5103/3/1E	€ x M*
XX-514010	€ x M*



5103/4/1E + 514010 + 034128

[parte esterna] [anello] [parte incasso]

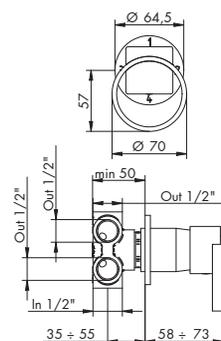

DEVIATORE INCASSO 4 USCITE
BUILT-IN DIVERTER 4 OUT

> deviatore a dischi ceramici 4 uscite senza chiusura
> attacchi da 1/2"
> abbinare a miscelatore o rubinetti d'arresto

P. EST. - CROMATO / MAN. CROMATO	
01-5103/4/1E	€
01-514010	€
PARTE INCASSO	
034128	€
PREZZO TOTALE	€

P. EST. - CROMATO / MAN. IN ALTRA FINITURA	
01-5103/4/1E	€
XX-514010	€ x M*
PARTI ESTERNE - ALTRE FINITURE	
XX-5103/4/1E	€ x M*
XX-514010	€ x M*



2212/PE + 514016 + 484020

[parte esterna] [kit maniglie] [parte incasso]

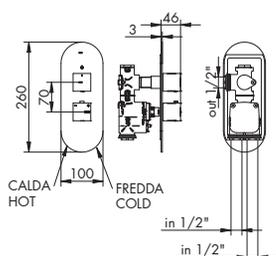

MISCELATORE TERMOSTATICO INCASSO 1 USCITA
BUILT-IN THERMOSTATIC MIXER 1 OUT

> cartuccia termostatica
> vitone ceramico 90°
> apertura con rotazione antioraria > interasse 70 mm
> ingressi inferiori da 1/2" > uscita laterale destra da 1/2"
> incasso con B-BOX > incasso regolabile min 76
> posizionabile orizzontalmente



8816/E + 775025
cromato € 20,00 + 23,00

P. EST. - CROMATO / MAN. CROMATO	
01-2212/PE	€
01-514016	€
PARTE INCASSO	
484020	€
PREZZO TOTALE	€

P. EST. - CROMATO / MAN. IN ALTRA FINITURA	
01-2212/PE	€
XX-514016	€ x M*
PARTI ESTERNE - ALTRE FINITURE	
XX-2212/PE	€ x M*
XX-514016	€ x M*



2212/2/PE + 514016 + 484021

[parte esterna] [kit maniglie] [parte incasso]

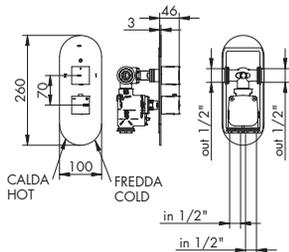

MISCELATORE TERMOSTATICO INCASSO C/DEVIATORE 2 USCITE
BUILT-IN THERMOSTATIC MIXER WITH DIVERTER 2 OUT

- > cartuccia termostatica
- > deviatore a dischi ceramici 2 uscite c/chiusura
- > interasse 70 mm
- > ingressi inferiori da 1/2"
- > incasso con B-BOX
- > uscite laterali da 1/2"
- > incasso regolabile min 76



PILETTA DOCCIA SHOWER WASTE
8816/E + 775025
cromato € 20,00 + 23,00

P. EST. - CROMATO / MAN. CROMATO

01-2212/2/PE	€
01-514016	€

P. EST. - CROMATO / MAN. IN ALTRA FINITURA

01-2212/2/PE	€
XX-514016	€ x M*

PARTE INCASSO

484021	€
--------	---

PARTI ESTERNE - ALTRE FINITURE

XX-2212/2/PE	€	x M*
XX-514016	€	x M*

PREZZO TOTALE €



MANIGLIA TEMPERATURA TEMPERATURE HANDLE

774037



MANIGLIA DEVIATORE DIVERTER HANDLE

774043



PIASTRA PLATE

484028



CARTUCCIA DEVIATRICE DIVERTER CARTRIDGE

035346



CART. TERMOSTATICA THERMOSTATIC CARTRIDGE

775007

2212/3/PE + 514016 + 484022

[parte esterna] [kit maniglie] [parte incasso]

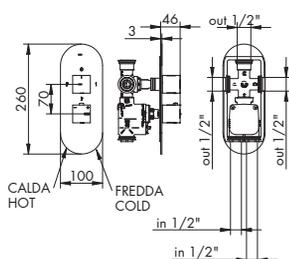

MISCELATORE TERMOSTATICO INCASSO C/DEVIATORE 3 USCITE
BUILT-IN THERMOSTATIC MIXER WITH DIVERTER 3 OUT

- > cartuccia termostatica
- > deviatore a dischi ceramici 3 uscite c/chiusura
- > interasse 70 mm
- > uscite laterali e superiore da 1/2"
- > incasso con B-BOX
- > ingressi inferiori da 1/2"
- > incasso regolabile min 76



PILETTA DOCCIA SHOWER WASTE
8816/E + 775025
cromato € 20,00 + 23,00

P. EST. - CROMATO / MAN. CROMATO

01-2212/3/PE	€
01-514016	€

P. EST. - CROMATO / MAN. IN ALTRA FINITURA

01-2212/3/PE	€
XX-514016	€ x M*

PARTE INCASSO

484022	€
--------	---

PARTI ESTERNE - ALTRE FINITURE

XX-2212/3/PE	€	x M*
XX-514016	€	x M*

PREZZO TOTALE €



MANIGLIA TEMPERATURA TEMPERATURE HANDLE

774037



MANIGLIA DEVIATORE DIVERTER HANDLE

774043



PIASTRA PLATE

484028



CARTUCCIA DEVIATRICE DIVERTER CARTRIDGE

035345



CART. TERMOSTATICA THERMOSTATIC CARTRIDGE

775007

2212/4/PE + 514016 + 484023

[parte esterna] [kit maniglie] [parte incasso]

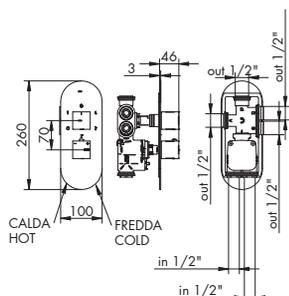

MISCELATORE TERMOSTATICO INCASSO C/DEVIATORE 4 USCITE
BUILT-IN THERMOSTATIC MIXER WITH DIVERTER 4 OUT

- > cartuccia termostatica
- > deviatore a dischi ceramici 4 uscite c/doppia chiusura
- > interasse 70 mm
- > uscite laterali e superiore da 1/2"
- > incasso con B-BOX
- > ingressi inferiori da 1/2"
- > incasso regolabile min 76



PILETTA DOCCIA SHOWER WASTE
8816/E + 775025
cromato € 20,00 + 23,00

P. EST. - CROMATO / MAN. CROMATO

01-2212/4/PE	€
01-514016	€

P. EST. - CROMATO / MAN. IN ALTRA FINITURA

01-2212/4/PE	€
XX-514016	€ x M*

PARTE INCASSO

484023	€
--------	---

PARTI ESTERNE - ALTRE FINITURE

XX-2212/4/PE	€	x M*
XX-514016	€	x M*

PREZZO TOTALE €



MANIGLIA TEMPERATURA TEMPERATURE HANDLE

774037



MANIGLIA DEVIATORE DIVERTER HANDLE

774043



PIASTRA PLATE

484028



CARTUCCIA DEVIATRICE DIVERTER CARTRIDGE

035344



CART. TERMOSTATICA THERMOSTATIC CARTRIDGE

775007

PER COMANDI TERMOSTATICI ALTA PORTATA, CONSULTARE SEZIONE REVIVRE.

FOR HIGH FLOW RATE THERMOSTATIC MIXER, LOOK AT THE "REVIVRE" COLLECTION.



8812/H/P/E + 774035

1 OUT ALTA PORTATA HIGH FLOW RATE



8812/2H/P/E + 774036

2 OUT ALTA PORTATA HIGH FLOW RATE



8812/3H/P/E + 774033

3 OUT ALTA PORTATA HIGH FLOW RATE



8812/4H/P/E + 774034

4 OUT ALTA PORTATA HIGH FLOW RATE



8812/H/E + 884036

1 OUT ALTA PORTATA HIGH FLOW RATE



8812/2H/E + 884037

2 OUT ALTA PORTATA HIGH FLOW RATE



8812/3H/E + 884038

3 OUT ALTA PORTATA HIGH FLOW RATE



8812/4H/E + 884039

4 OUT ALTA PORTATA HIGH FLOW RATE

5109/1 + 514010

[mix] [anello]

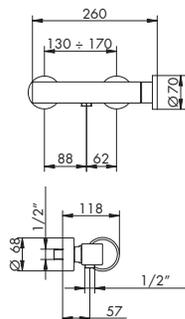
MISCELATORE DOCCIA ESTERNO
EXTERNAL SHOWER MIXER

- > cartuccia tradizionale
- > senza set doccia
- > attacchi da 1/2"

PILETTA DOCCIA
SHOWER WASTE8816/E + 775025
cromato € 20,00 + 23,00

CROMATO / MAN. CROMATO

01-5109/1	€
01-514010	€

PREZZO TOTALE €

CROMATO / MANIGLIA IN ALTRA FINITURA

01-5109/1	€	
XX-514010	€	x M*

ALTRE FINITURE

XX-5109/1	€	x M*
XX-514010	€	x M*

CORPO MANIGLIA
HANDLE BODY

514013

ECCENTRICO (1 PZ)
ROSETTE (1 PC)

014017

CARTUCCIA
CARTRIDGE

025002

DOCCIA COMPLEMENTI CONSIGLIATI:

PER SOLUZIONI ALTERNATIVE E LISTINO PREZZI, CONSULTARE LA SEZIONE COMPLETA.

SUGGESTED "DOCCIA COMPLEMENTI":

FOR ALTERNATIVE SOLUTIONS AND PRICE LIST, SEE THE COMPLETE COLLECTION.

4403/1/A, 4403/1
SUPPORTO DOCCIA COMPLETO
FULL SHOWER SUPPORT4630
SALISCENDI COMPLETO C/PRESA D'ACQUA
COMPLETE WALL PIPE WITH WATER CONNECTION0413/4/SP
STELO DOCCIA
ROD SHOWER0413/5/1/SP
CURVA PRESA ACQUA C/STELO COMPLETO
CURVE WATER CONNECTOR WITH COMPLETE ROD

SOFFIONI E BRACCI CONSIGLIATI:

PER SOLUZIONI ALTERNATIVE E LISTINO PREZZI, CONSULTARE LA SEZIONE COMPLETA.
PER COMPOSIZIONI DOCCIA CONSULTARE SEZIONE REVIVRE.

SUGGESTED "BRACCI E SOFFIONI":

FOR ALTERNATIVE SOLUTIONS AND PRICE LIST, SEE THE COMPLETE COLLECTION.
FOR SHOWER TYPESSETTING LOOK AT "REVIVRE" COLLECTION.045230
SOFFIONE Ø 200 OTTONE
BRASS CEILING DIAMETER 200045174
SOFFIONE Ø 300 OTTONE
BRASS CEILING DIAMETER 300884055
BRACCIO DA PARETE MM 350
WALL ARM MM 350044054
BRACCIO A SOFFITTO MM 250
CEILING ARM MM 250

COMPONI IL TUO SET DOCCIA:

PER SOLUZIONI ALTERNATIVE E LISTINO PREZZI, CONSULTARE LA SEZIONE COMPLETA.

DESIGN YOUR SHOWER SET:

FOR ALTERNATIVE SOLUTIONS AND PRICE LIST, SEE THE COMPLETE COLLECTION.

014083
GANCIO INCASSO FISSO
BUILT-IN FIXED HOOK014084
SUPPORTO ESTERNO FISSO
EXTERNAL FIXED SUPPORT445043 OTTONE
DOCCETTA MONOGETTO
MONO JET HAND SHOWER915001 ABS
DOCCETTA MONOGETTO
MONO JET HAND SHOWER915003
FLESSIBILE TUBO PVC L150 CM
PVC TUBE FLEXIBLE L150 CM655016
FLESSIBILE TRECCIA OTTONE L150 CM
BRASS FLEXIBLE L150 CM4630/1
ASTA SALISCENDI
WALL PIPE

5101/A + 514010

[mix] [anello]

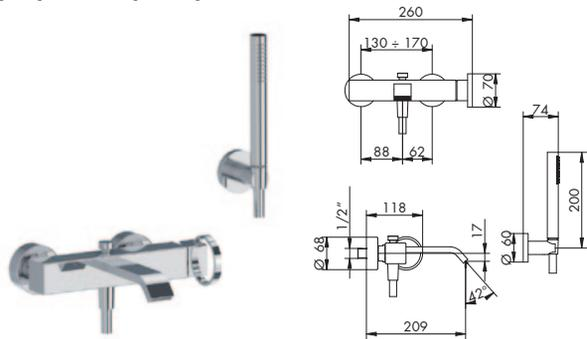

MISCELATORE VASCA ESTERNO
EXTERNAL BATH MIXER

- > cartuccia tradizionale
- > interasse bocca 207
- > deviatore a trazione c/ritorno automatico e blocco meccanico basse pressioni
- > flessibile in PVC 150 cm
- > doccetta monogetto cilindrica in ABS c/anticalcare, per finiture diverse da cromo doccetta in metallo
- > attacchi da 1/2"
- > supporto a parete fisso



CROMATO / MAN. CROMATO

01-5101/A	€
01-514010	€

PREZZO TOTALE €

CROMATO / MANIGLIA IN ALTRA FINITURA

01-5101/A	€
XX-514010	€ x M*

ALTRE FINITURE

XX-5101/A	€	x M*
XX-514010	€	x M*



5103

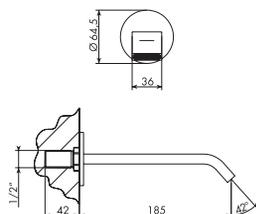

BOCCA VASCA DA PARETE
WALL BATH SPOUT

- > interasse bocca 185
- > Attacchi da 1/2"



CROMATO

01-5103	€
---------	---

ALTRE FINITURE

XX-5103	€	x M*
---------	---	------



044071

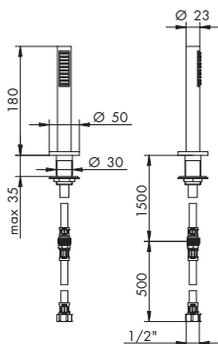

SUPPORTO DOCCIA BV TONDO COMPLETO
COMPLETE ROUND HAND SHOWER SET FOR BATH RIM

- > flessibile in PVC 150 cm
- > attacco da 1/2"
- > doccetta monogetto cilindrica in ABS c/anticalcare, per finiture diverse da cromo doccetta in metallo

CROMATO

01-044071	€
-----------	---

ALTRE FINITURE

XX-044071	€	x M*
-----------	---	------

^ MOLTIPLICATORE DOCCIA
COMPLEMENTI - GRUPPO D, PAG. 120
LISTINO REVIVRE
^ MULTIPLIER DOCCIA COMPLEMENTI -
"D" GROUP, PAGE 120 REVIVRE PRICE LIST



5108/E + 514010 + 054025

[parte esterna] [anello] [parte incasso]

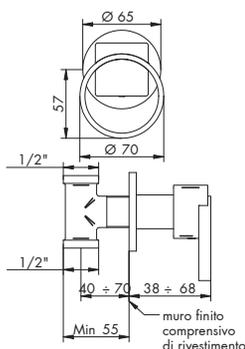

RUBINETTO D'ARRESTO 1/2"
BUILT-IN STOP COCK 1/2"

- > vitone ceramico 90°
- > ingressi da 1/2"

P. EST. - CROMATO / MAN. CROMATO

01-5108/E	€
01-514010	€

PARTE INCASSO

054025	€
--------	---

PREZZO TOTALE €

P. EST. - CROMATO / MAN. IN ALTRA FINITURA

01-5108/E	€
XX-514010	€ x M*

PARTI ESTERNE - ALTRE FINITURE

XX-5108/E	€	x M*
XX-514010	€	x M*



5108/E + 514010 + 054027

[parte esterna] [anello] [parte incasso]

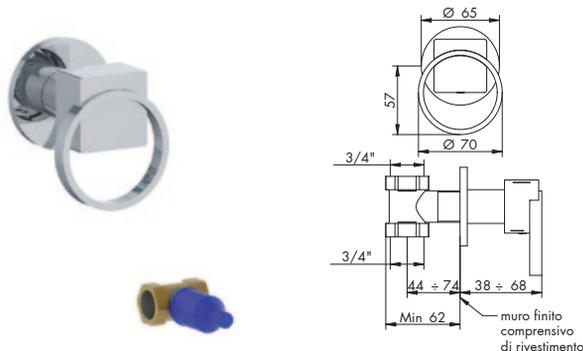

RUBINETTO D'ARRESTO 3/4"

BUILT-IN STOP COCK 3/4"

> vitone ceramico 90°
> ingressi da 3/4"

P. EST. - CROMATO / MAN. CROMATO	
01-5108/E	€
01-514010	€
PARTE INCASSO	
054027	€
PREZZO TOTALE	€

P. EST. - CROMATO / MAN. IN ALTRA FINITURA	
01-5108/E	€
XX-514010	€ x M*
PARTI ESTERNE - ALTRE FINITURE	
XX-5108/E	€ x M*
XX-514010	€ x M*



5140/E + 514010 + 654099

[parte esterna] [anello] [parte incasso]

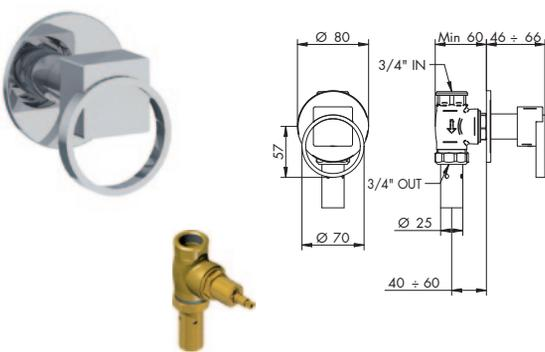

PASSO RAPIDO 3/4"

BUILT-IN RAPID FLOW COCK 3/4"

> vitone tradizionale
> abbinare a saracinesca
> ingressi da 3/4"

P. EST. - CROMATO / MAN. CROMATO	
01-5140/E	€
01-514010	€
PARTE INCASSO	
654099	€
PREZZO TOTALE	€

P. EST. - CROMATO / MAN. IN ALTRA FINITURA	
01-5140/E	€
XX-514010	€ x M*
PARTI ESTERNE - ALTRE FINITURE	
XX-5140/E	€ x M*
XX-514010	€ x M*



5140/E + 514010 + 654100

[parte esterna] [anello] [parte incasso]

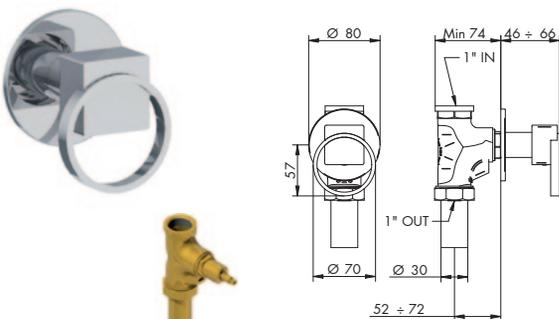

PASSO RAPIDO 1"

BUILT-IN RAPID FLOW COCK 1"

> vitone tradizionale
> abbinare a saracinesca
> ingressi da 1"

P. EST. - CROMATO / MAN. CROMATO	
01-5140/E	€
01-514010	€
PARTE INCASSO	
654100	€
PREZZO TOTALE	€

P. EST. - CROMATO / MAN. IN ALTRA FINITURA	
01-5140/E	€
XX-514010	€ x M*
PARTI ESTERNE - ALTRE FINITURE	
XX-5140/E	€ x M*
XX-514010	€ x M*



5132/2/E + 514010 + 035212

[parte esterna] [anello] [parte incasso]

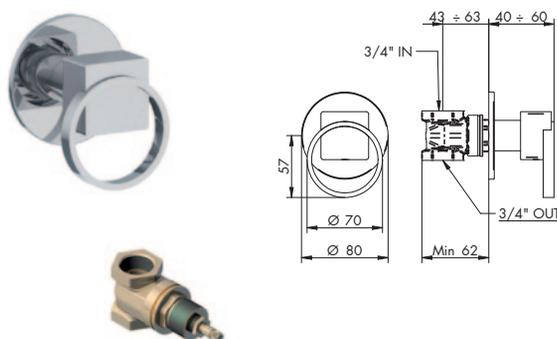

SARACINESCA

GATE VALVE

> attacchi da 3/4"

P. EST. - CROMATO / MAN. CROMATO	
01-5132/2/E	€
01-514010	€
PARTE INCASSO	
035212	€
PREZZO TOTALE	€

P. EST. - CROMATO / MAN. IN ALTRA FINITURA	
01-5132/2/E	€
XX-514010	€ x M*
PARTI ESTERNE - ALTRE FINITURE	
XX-5132/2/E	€ x M*
XX-514010	€ x M*



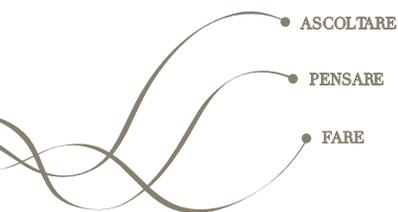

• ASCOLTARE

• PENSARE

• FARE

ASCOLTARE, PENSARE, FARE è la formula che abbiamo scelto per descrivere l'attenzione con cui interpretiamo i desideri del cliente, elaboriamo soluzioni ed esprimiamo proposte che ne soddisfino i gusti e le esigenze. Con lo stesso spirito, con lo stesso entusiasmo, oggi come sessant'anni fa.

LISTEN, THINK, ACT is the philosophy that we use to describe the attention by which we interpret the wishing of the client, we find solution and make proposal for meet the taste and exigent. With the same mind and passion, today like sixty years ago.

© 2021 Bellosta Rubinetterie. Tutti i diritti riservati.

GRAPHIC:
Roberta Teruggi

CONCEPT:
aCB

BELLOSTA CARLO & C. RUBINETTERIE Srl
Via S. Botticelli, 12/14 | 28024 Briga Novarese (No) Italia
Ingresso showroom: Largo Carlo Bellosta | Briga Novarese (No) Italia
Atelier Milano: Via Montenapoleone, 22
Atelier Roma: Piazza di Spagna, ingresso Via Gregoriana 23

T +39 0322 956 425 | 0322 912 330 | 0322 946 84
F +39 0322 955 368 | info@bellostarubinetterie.com
Export department: estero@bellostarubinetterie.com

Follow us on facebook, youTube, linked in, twitter, pinterest, instagram, houzz

Visit our website on bellostarubinetterie.com

SPECIAL THANKS TO:
Florim | www.florim.com