



## GOLD collection

INFO TECNICHE pag. 399

TABELLA PREZZI FINITURE pag. 400



CONSULTA LISTINO ON LINE  
CHECK ON LINE PRICE LIST

[www.bellostarubinetterie.com/online/22\\_b-uno\\_b-due.pdf](http://www.bellostarubinetterie.com/online/22_b-uno_b-due.pdf)

## INDICE | INDEX

LAVABO	pag. 401/408
BIDET	pag. 408/409
DOCCIA INCASSO	pag. 409/411
DEVIATORI INCASSO	pag. 411/413
DOCCIA INCASSO TERMOSTATICO	pag. 413/414
DOCCIA ESTERNO	pag. 414/415
DOCCIA COMPLEMENTI	pag. 415
SOFFIONI/BRACCI	pag. 415
COMPONI SET DOCCIA	pag. 415
VASCA	pag. 416/419
BAGNO COMPLEMENTI	pag. 419/421
RICAMBI	pag. 422

## FORATURA DEI PIANI SANITARI

I miscelatori lavabo/bidet monoforo prevedono un foro di diametro 35 mm nel piano sanitario.

MONOFORO >>

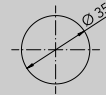

## DRILLING PLANS HEALTH

The sink / hole bidet mixers provide a hole diameter of 35 mm in the health plan.

## INSTALLAZIONE LAVABI A MURO

Distanza verticale consigliata tra l'uscita dell'acqua ed il bordo superiore del lavabo 8±10 cm.

## WALL-MOUNTED WASHBASIN INSTALLATION

Recommended vertical distance between the water outlet and the upper edge of the sink 8±10 cm.

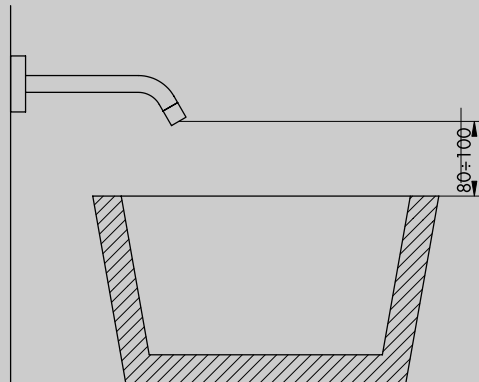

## SCHEMA FUNZIONAMENTO DEVIATORI INCASSO 2/3/4 USCITE

Questi deviatori non hanno funzione di chiusura. Ruotando verso destra o sinistra si attivano le uscite. Tra 2 uscite adiacenti durante la rotazione diminuisce la portata dell'uscita iniziale ed incrementa quella della successiva. In posizione intermedia sono entrambe attive a pari portata.

## SCHEME OPERATION SWITCHES FLUSH OUTPUT 2/3/4

These diverters have not closing function. By turning to the right or left activates the outputs. Between two adjacent outputs during the rotation decreases the initial output flow and increases that of the next. In position intermediate are both active at the same flow rate.

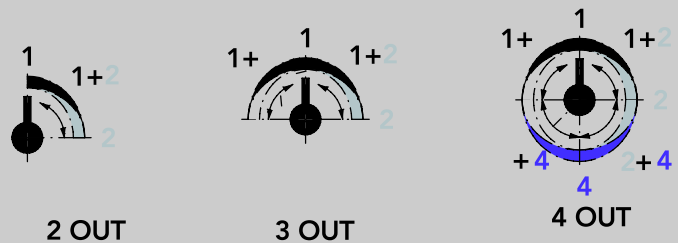

## SCHEMA FUNZIONAMENTO MISCELATORI TERMOSTATICI 2/3/4 USCITE

Leva in posizione ore 12 = deviatore chiuso. Ruotando verso destra o sinistra si attivano le diverse uscite. Partendo dalla posizione di STOP, durante la rotazione la portata dell'acqua si incrementa verso la posizione successiva. Tra 2 uscite adiacenti durante la rotazione diminuisce la portata dell'uscita iniziale ed incrementa quella della successiva. In posizione intermedia sono entrambe attive a pari portata.

## SCHEME OPERATING THERMOSTATIC MIXER 2/3/4 OUT

Lever to the 12 o'clock position = switch closed. Turning left or right. They activate different outputs. Starting from the STOP position, while rotation of the water flow rate between two adjacent outputs is increased towards the next position. Between two adjacent outputs during the rotation decreases the initial output flow and increases that of the next. In position intermediate are both active at the same flow rate.

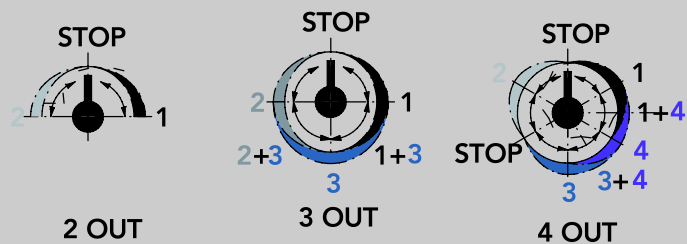

## CONSIGLIO TECNICO

Tutti i miscelatori delle collezioni B-UNO e B-DUE vengono collaudati nel loro funzionamento al momento dell'assemblaggio. Per garantire la durata delle cartucce nel tempo, si consiglia di spurgare bene l'impianto idraulico prima del montaggio (per rimuovere eventuali detriti) e di installare rubinetti sottolavabo con filtro (art. 0920).

N.B.: Qualora il piano lavabo avesse uno spessore superiore a 5 cm specificare la misura al momento dell'ordine.

## TECHNICAL ADVICE

All mixers of the B-UNO and B-DUE collections are perfectly tested. To guarantee the perfect functionality of the cartridge for a long time, we advise to clean the sanitary plant before installing the mixer. Moreover we advise to install angle valve with filter (art. 0920).

Attention: If the lavatory top is more than cm 5 thick, please point it out when placing the order.

## EROGAZIONE D'ACQUA

Le collezioni B-UNO e B-DUE utilizzano di serie erogazione con getto aerato; la manutenzione avviene come da schema.

## WATER SUPPLY

The collection B-UNO and B-DUE are supplied by aerated water jet, the maintenance is made like scheme.



## PROGETTO SU MISURA: RICHIESTE SPECIALI

I tecnici di Bellosta Rubinetterie sono, inoltre, a disposizione di architetti e designers, per offrire un servizio esclusivo: personalizzazioni di elementi in funzione di specifiche richieste estetiche o problematiche legate a vincoli progettuali, verifica della fattibilità attraverso opportuni studi CAD e sviluppo del disegno tecnico del prodotto speciale richiesto.

Per informazioni e richieste PROGETTI SU MISURA:

ufficiotecnico@bellostarubinetterie.com

## PROGETTO SU MISURA: SPECIAL REQUESTS

Engineers Bellosta Rubinetterie are also available to architects and designers, to offer an exclusive service: customizations of items according to specific aesthetic requirements or issues related to design constraints, verification of the feasibility studies and development through appropriate CAD technical design the required special product. For information and requests "SU MISURA" PROJECTS:

ufficiotecnico@bellostarubinetterie.com

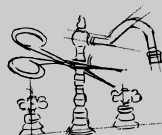

progetto  
"sumisura"

**PREZZO FINITURE**

Calcola il prezzo di listino (IVA esclusa) delle finiture diverse dal cromato, consultando la seguente tabella.

Moltiplicare il **PREZZO LISTINO** per il **COEFFICIENTE MOLTIPLICATORE** della finitura scelta, arrotondando per difetto il prezzo ottenuto (eliminare i centesimi).  
**ESEMPIO** per ordinare art. 7905 in finitura dorato: codice 04-7905

**PRICE FINISHES**

Include the list price (excluding VAT) of different finishes from chrome, consulting the following table. **Multiply the PRICE LIST MULTIPLIER COEFFICIENT** of the chosen finish, **reducing the price obtained by deleting the centesim.**

**EXAMPLE** to order art. 7905 gold finish: code 04-7905

**COMPOSIZIONE CODICE PER ORDINARE ARTICOLO IN FINITURA**

**XX** - **7905**

**CODICE FINITURA**  
FINISH CODE

**CODICE ARTICOLO**  
ITEM NUMBER

**MOLTIPLICATORI FINITURE DI SERIE**  
**STANDARD FINISHES MULTIPLIERS**

COD. CODE	DESCRIZIONE FINITURA FINISH DESCRIPTION	B-UNO B-DUE	RICAMBI	COMANDI QUADRO	DOCCIA COMPL.
01-	cromato/chrome	<b>PREZZO LISTINO°</b>			
33-	cromo satinato/satin chrome				
34-	cromo spazzolato/brushing chrome				
35-	nickel spazzolato/brushing nickel				
66-	bianco opaco/mat white				

**MOLTIPLICATORI FINITURE A RICHIESTA**  
**ON REQUEST FINISHES MULTIPLIERS**

COD. CODE	DESCRIZIONE FINITURA FINISH DESCRIPTION	B-UNO B-DUE	RICAMBI	COMANDI QUADRO	DOCCIA COMPL.
58-	verdino/light green				
59-	marrone/brown				
60-	arancio/orange				
61-	rosso/red				
67-	nero opaco/matt black				
68-	rame opaco/matt copper				
69-	argento opaco/matt silver				
71-	oro opaco/matt gold				
72-	bronzo opaco/matt bronze				
75-	dorato spazzolato/brushing gold				
87-	oro rosa/pink gold				
88-	ottone sisal/sisal brass				
89-	industrial				
92-	pomice opaco/matt pumice				
93-	arenaria opaco/matt sandstone				
94-	tuscany spazzolato/brushing tuscany				
95-	rame acidato/etched copper				
96-	cemento opaco/matt cement				
A1-	brina opaco/matt frost				
A2-	tuscany cerato/oilskin tuscany				
A3-	ottone acidato/etched brass				
A4-	basalto opaco/matt basalt				
B2-	black gun metal PVD				
B3-	nickel PVD				
B4-	matt gold PVD				

**MOLTIPLICATORI FINITURE A RICHIESTA**  
**ON REQUEST FINISHES MULTIPLIERS**

COD. CODE	DESCRIZIONE FINITURA FINISH DESCRIPTION	B-UNO B-DUE	RICAMBI	COMANDI QUADRO	DOCCIA COMPL.
02-	cromo/oro/chrome/gold				
03-	oro/argento/gold/silver				
04-	dorato/gold				
05-	bronzo satinato/satin bronze				
06-	rame vecchio/old copper				
07-	vecchio argento/old silver				
08-	canna di fucile/gun barrel				
10-	verderame/verdigris				
11-	nero antracite/anthracite black				
12-	ottone lucido/polished brass				
13-	ottone naturale/natural brass				
14-	bianco lucido/glossy white				
19-	nero lucido/glossy black				
28-	nickel satinato/satin nickel				
30-	nickel lucido/polished nickel				
56-	cavorio/ivory				
57-	azzurro/light blue				

°PREZZO DI LISTINO PRICE LIST  
RICAMBI SPARE PARTS

\* N.R. = NON REALIZZABILE NOT MADE  
COMANDI QUADRO SQUARE DRIVER

RICH. = PREZZO A RICHIESTA ON REQUEST PRICE  
DOCCIA COMPLEMENTI SHOWER COMPLEMENTS

**NOTE:**

Flex art. 915003 realizzabile nelle seguenti finiture:  
 01,03,04,05,06,07,12,13,19,28,30,33,34,35,66,67,68,69,71,72,75,B2,B3,B4.  
 Per altre finiture ordinare art. 655016.

**NOTE:**

Flex art. 915003 is available in the following finishes:  
 01,03,04,05,06,07,12,13,19,28,30,33,34,35,66,67,68,69,71,72,75,B2,B3,B4.  
 For other colors order the art. 655016.

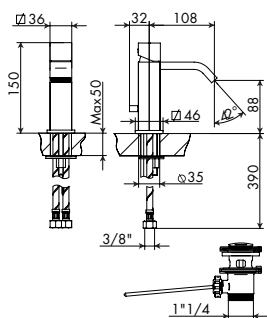

## 7905 | B-UNO

MISCELATORE LAVABO MONOFORO  
BASIN MIXER

- > cartuccia tradizionale
- > interasse bocca 108
- > flessibili di alimentazione
- > con scarico
- > abbinare a rubinetto sottolavabo con filtro (art. 0920)

SIFONE  
SIPHON

6533 p. 879

## CROMATO

01-7905

## ALTRE FINITURE

XX-7905

x M\*

AERATORE C/CHIAVE  
AERATOR W/KEY

795004

CARTUCCIA  
CARTRIDGE

735005

## 7905/L | B-DUE

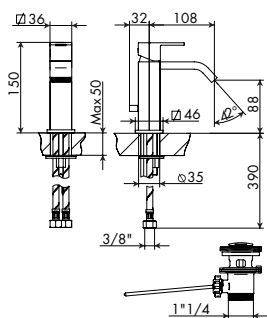
MISCELATORE LAVABO MONOFORO  
BASIN MIXER

- > cartuccia tradizionale
- > interasse bocca 108
- > flessibili di alimentazione
- > con scarico
- > abbinare a rubinetto sottolavabo con filtro (art. 0920)

SIFONE  
SIPHON

6533 p. 879

## CROMATO

01-7905/L

## ALTRE FINITURE

XX-7905/L

x M\*

AERATORE C/CHIAVE  
AERATOR W/KEY

795004

CARTUCCIA  
CARTRIDGE

735005

## 7905/S | B-UNO

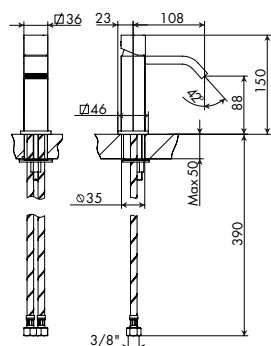
MISCELATORE LAVABO MONOFORO  
BASIN MIXER

- > cartuccia tradizionale
- > interasse bocca 108
- > flessibili di alimentazione
- > senza scarico
- > abbinare a rubinetto sottolavabo con filtro (art. 0920)

SCARICO LAVABO  
BASIN VASTE

6536/U p. 884

SIFONE  
SIPHON

6533 p. 879

## CROMATO

01-7905/S

## ALTRE FINITURE

XX-7905/S

x M\*

AERATORE C/CHIAVE  
AERATOR W/KEY

795004

CARTUCCIA  
CARTRIDGE

735005

## 7905/SL | B-DUE

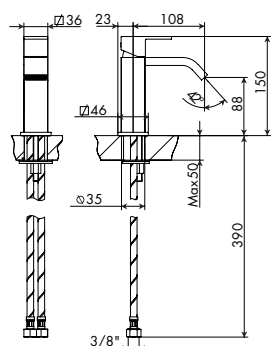
MISCELATORE LAVABO MONOFORO  
BASIN MIXER

- > cartuccia tradizionale
- > interasse bocca 108
- > flessibili di alimentazione
- > senza scarico
- > abbinare a rubinetto sottolavabo con filtro (art. 0920)

SCARICO LAVABO  
BASIN VASTE

6536/U p. 884

SIFONE  
SIPHON

6533 p. 879

## CROMATO

01-7905/SL

## ALTRE FINITURE

XX-7905/SL

x M\*

AERATORE C/CHIAVE  
AERATOR W/KEY

795004

CARTUCCIA  
CARTRIDGE

735005

## 7905/P | B-UNO

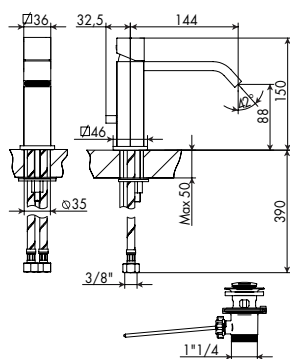

## MISCELATORE LAVABO MONOFORO BOCCA PROLUNGATA

## BASIN MIXER EXTENDED SPOUT

- > cartuccia tradizionale
- > interasse bocca 144
- > flessibili di alimentazione
- > con scarico
- > abbinare a rubinetto sottolavabo con filtro (art. 0920)

SIFONE  
SIPHON

6533 p. 879

## CROMATO

01-7905/P

## ALTRE FINITURE

XX-7905/P

x M\*

AERATORE C/CHIAVE  
AERATOR W/KEY

795004

CARTUCCIA  
CARTRIDGE

735005

## 7905/PL | B-DUE

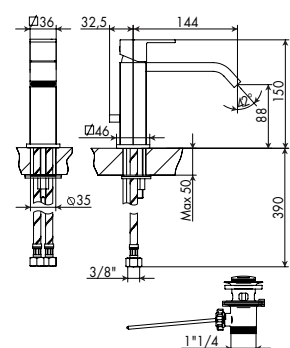

## MISCELATORE LAVABO MONOFORO BOCCA PROLUNGATA

## BASIN MIXER EXTENDED SPOUT

- > cartuccia tradizionale
- > interasse bocca 144
- > flessibili di alimentazione
- > con scarico
- > abbinare a rubinetto sottolavabo con filtro (art. 0920)

SIFONE  
SIPHON

6533 p. 879

## CROMATO

01-7905/PL

## ALTRE FINITURE

XX-7905/PL

x M\*

AERATORE C/CHIAVE  
AERATOR W/KEY

795004

CARTUCCIA  
CARTRIDGE

735005

## 7905/P/S | B-UNO

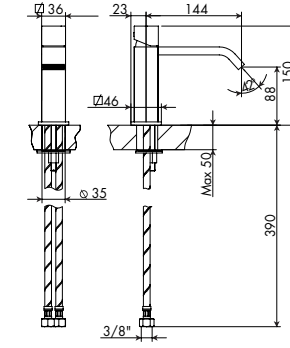

## MISCELATORE LAVABO MONOFORO BOCCA PROLUNGATA

## BASIN MIXER EXTENDED SPOUT

- > cartuccia tradizionale
- > interasse bocca 144
- > flessibili di alimentazione
- > senza scarico
- > abbinare a rubinetto sottolavabo con filtro (art. 0920)

SCARICO LAVABO  
BASIN WASTE

6536/U p. 884

SIFONE  
SIPHON

6533 p. 879

## CROMATO

01-7905/P/S

## ALTRE FINITURE

XX-7905/P/S

x M\*

AERATORE C/CHIAVE  
AERATOR W/KEY

795004

CARTUCCIA  
CARTRIDGE

735005

## 7905/P/SL | B-DUE

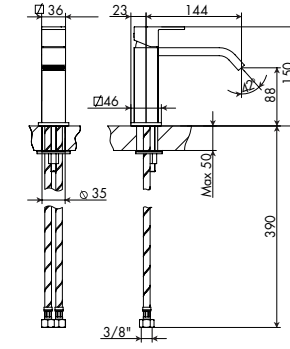

## MISCELATORE LAVABO MONOFORO BOCCA PROLUNGATA

## BASIN MIXER EXTENDED SPOUT

- > cartuccia tradizionale
- > interasse bocca 144
- > flessibili di alimentazione
- > senza scarico
- > abbinare a rubinetto sottolavabo con filtro (art. 0920)

SCARICO LAVABO  
BASIN WASTE

6536/U p. 884

SIFONE  
SIPHON

6533 p. 879

## CROMATO

01-7905/P/SL

## ALTRE FINITURE

XX-7905/P/SL

x M\*

AERATORE C/CHIAVE  
AERATOR W/KEY

795004

CARTUCCIA  
CARTRIDGE

735005

## 7905/P/A | B-UNO

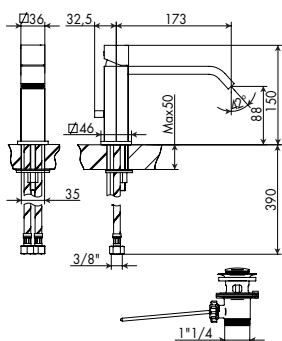
MISCELATORE LAVABO MONOFORO BOCCA EXTRAPROLUNGATA  
BASIN MIXER EXTRA EXTENDED SPOUT

- > cartuccia tradizionale
- > interasse bocca 173
- > flessibili di alimentazione
- > con scarico
- > abbinare a rubinetto sottolavabo con filtro (art. 0920)

SIFONE  
SIPHON

6533 p. 879

## CROMATO

01-7905/P/A

## ALTRE FINITURE

XX-7905/P/A

x M\*

AERATORE C/CHIAVE  
AERATOR W/KEY

795004

CARTUCCIA  
CARTRIDGE

735005

## 7905/P/AL | B-DUE

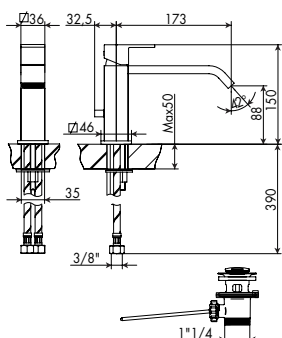
MISCELATORE LAVABO MONOFORO BOCCA EXTRAPROLUNGATA  
BASIN MIXER EXTRA EXTENDED SPOUT

- > cartuccia tradizionale
- > interasse bocca 173
- > flessibili di alimentazione
- > con scarico
- > abbinare a rubinetto sottolavabo con filtro (art. 0920)

SIFONE  
SIPHON

6533 p. 879

## CROMATO

01-7905/P/AL

## ALTRE FINITURE

XX-7905/P/AL

x M\*

AERATORE C/CHIAVE  
AERATOR W/KEY

795004

CARTUCCIA  
CARTRIDGE

735005

## 7905/P/A/S | B-UNO

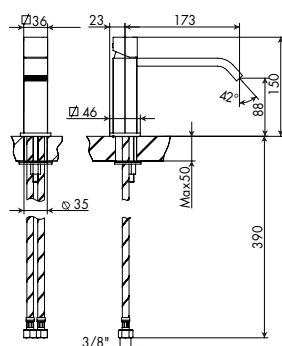
MISCELATORE LAVABO MONOFORO BOCCA EXTRAPROLUNGATA  
BASIN MIXER EXTRA EXTENDED SPOUT

- > cartuccia tradizionale
- > interasse bocca 173
- > flessibili di alimentazione
- > senza scarico
- > abbinare a rubinetto sottolavabo con filtro (art. 0920)

SCARICO LAVABO  
BASIN VASTE

6536/U p. 884

SIFONE  
SIPHON

6533 p. 879

## CROMATO

01-7905/P/A/S

## ALTRE FINITURE

XX-7905/P/A/S

x M\*

AERATORE C/CHIAVE  
AERATOR W/KEY

795004

CARTUCCIA  
CARTRIDGE

735005

## 7905/P/A/SL | B-DUE

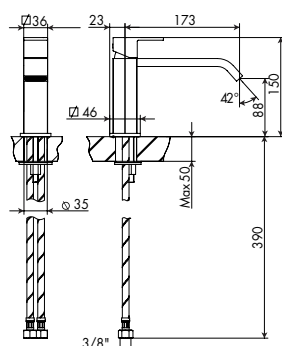
MISCELATORE LAVABO MONOFORO BOCCA EXTRAPROLUNGATA  
BASIN MIXER EXTRA EXTENDED SPOUT

- > cartuccia tradizionale
- > interasse bocca 173
- > flessibili di alimentazione
- > senza scarico
- > abbinare a rubinetto sottolavabo con filtro (art. 0920)

SCARICO LAVABO  
BASIN VASTE

6536/U p. 884

SIFONE  
SIPHON

6533 p. 879

## CROMATO

01-7905/P/A/SL

## ALTRE FINITURE

XX-7905/P/A/SL

x M\*

AERATORE C/CHIAVE  
AERATOR W/KEY

795004

CARTUCCIA  
CARTRIDGE

735005

794001 | 794002 | 794003



PROLUNGHE MISCELATORE LAVABO

EXTENSIONS FOR BASIN

- > Ø 36 mm
- > altezza 100 mm, 150 mm, 180 mm

CROMATO

01-794001	100 mm
01-794002	150 mm
01-794003	180 mm

ALTRE FINITURE

XX-794001	100 mm	x M*
XX-794002	150 mm	x M*
XX-794003	180 mm	x M*

7905/1 | B-UNO

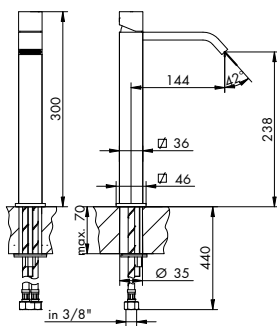

MIX LAVABO MONOFORO ALTO BOCCA PROLUNGATA

HIGHER BASIN MIXER EXTENDED SPOUT

- > cartuccia tradizionale
- > interasse bocca 144
- > flessibili di alimentazione
- > senza scarico
- > abbinare a rubinetto sottolavabo con filtro (art. 0920)



SCARICO LAVABO  
BASIN WASTE



SIFONE  
SIPHON

6536/U p. 884

6533 p. 879

CROMATO

01-7905/1
-----------

ALTRE FINITURE

XX-7905/1	x M*
-----------	------



AERATORE C/CHIAVE  
AERATOR W/KEY



CARTUCCIA  
CARTRIDGE

795004

735005

7905/1/L | B-DUE

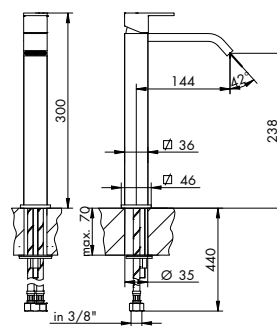

MIX LAVABO MONOFORO ALTO BOCCA PROLUNGATA

HIGHER BASIN MIXER EXTENDED SPOUT

- > cartuccia tradizionale
- > interasse bocca 144
- > flessibili di alimentazione
- > senza scarico
- > abbinare a rubinetto sottolavabo con filtro (art. 0920)



SCARICO LAVABO  
BASIN WASTE



SIFONE  
SIPHON

6536/U p. 884

6533 p. 879

CROMATO

01-7905/1/L
-------------

ALTRE FINITURE

XX-7905/1/L	x M*
-------------	------



AERATORE C/CHIAVE  
AERATOR W/KEY



CARTUCCIA  
CARTRIDGE

795004

735005

7905/1/P | B-UNO

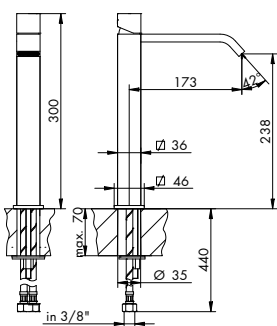

MIX LAVABO MONOFORO ALTO BOCCA EXTRA PROLUNGATA

HIGHER BASIN MIXER EXTRA EXTENDED SPOUT

- > cartuccia tradizionale
- > interasse bocca 173
- > flessibili di alimentazione
- > senza scarico
- > abbinare a rubinetto sottolavabo con filtro (art. 0920)



SCARICO LAVABO  
BASIN WASTE



SIFONE  
SIPHON

6536/U p. 884

6533 p. 879

CROMATO

01-7905/1/P
-------------

ALTRE FINITURE

XX-7905/1/P	x M*
-------------	------



AERATORE C/CHIAVE  
AERATOR W/KEY



CARTUCCIA  
CARTRIDGE

795004

735005

## 7905/1/PL | B-DUE

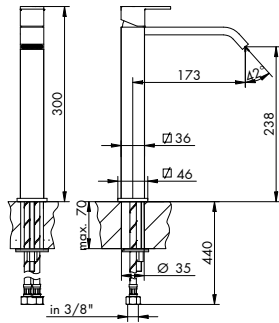
MIX LAVABO MONOFORO ALTO BOCCA EXTRA PROLUNGATA  
HIGHER BASIN MIXER EXTRA EXTENDED SPOUT

- > cartuccia tradizionale
- > interasse bocca 173
- > flessibili di alimentazione
- > senza scarico
- > abbinare a rubinetto sottolavabo con filtro (art. 0920)



6536/U p. 884



6533 p. 879

CROMATO  
01-7905/1/PLALTRE FINITURE  
XX-7905/1/PL

x M\*



795004



735005

## 7905/3/A/E + 894001 | B-UNO

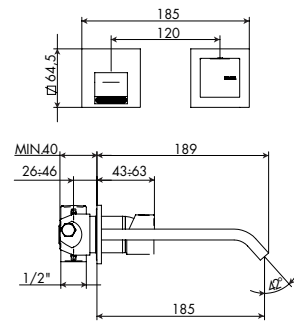
MISCELATORE LAVABO DA PARETE  
WALL BASIN MIXER

- > cartuccia tradizionale
- > interasse bocca 185
- > ingressi da 1/2"
- > senza scarico
- > rosoni separati



6536/U p. 884



6533 p. 879

PARTI ESTERNE - CROMATO  
01-7905/3/A/EPARTI ESTERNE - ALTRE FINITURE  
XX-7905/3/A/E

x M\*

PARTE INCASSO

01-894001 info pag. 30

PREZZO TOTALE



PER INSTALLAZIONI SU PARETI IN CARTONGESSO VERIFICARE LE DIMENSIONI DEL PANNELLO E ORDINARE LA NECESSARIA PROLUNGA  
FOR INSTALLATIONS ON DRYWALL, CHECK THE DIMENSIONS OF THE PANEL AND ORDER THE NECESSARY EXTENSION



795004



025002

## 7905/3/AL/E + 894001 | B-DUE

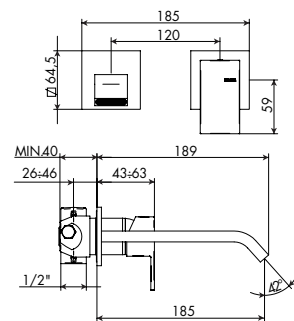
MISCELATORE LAVABO DA PARETE  
WALL BASIN MIXER

- > cartuccia tradizionale
- > interasse bocca 185
- > ingressi da 1/2"
- > senza scarico
- > rosoni separati



6536/U p. 884



6533 p. 879

PARTI ESTERNE - CROMATO  
01-7905/3/AL/EPARTI ESTERNE - ALTRE FINITURE  
XX-7905/3/AL/E

x M\*

PARTE INCASSO

01-894001 info pag. 30

PREZZO TOTALE



PER INSTALLAZIONI SU PARETI IN CARTONGESSO VERIFICARE LE DIMENSIONI DEL PANNELLO E ORDINARE LA NECESSARIA PROLUNGA  
FOR INSTALLATIONS ON DRYWALL, CHECK THE DIMENSIONS OF THE PANEL AND ORDER THE NECESSARY EXTENSION



795004



025002

## 7905/3/B/E + 894001 | B-UNO

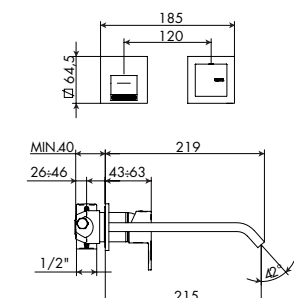
MISCELATORE LAVABO DA PARETE BOCCA PROLUNGATA  
WALL BASIN EXTENDED SPOUT MIXER

- > cartuccia tradizionale
- > interasse bocca 215
- > ingressi da 1/2"
- > senza scarico
- > rosoni separati



6536/U p. 884



6533 p. 879

PARTI ESTERNE - CROMATO  
01-7905/3/B/EPARTI ESTERNE - ALTRE FINITURE  
XX-7905/3/B/E

x M\*

PARTE INCASSO

01-894001 info pag. 30

PREZZO TOTALE



PER INSTALLAZIONI SU PARETI IN CARTONGESSO VERIFICARE LE DIMENSIONI DEL PANNELLO E ORDINARE LA NECESSARIA PROLUNGA  
FOR INSTALLATIONS ON DRYWALL, CHECK THE DIMENSIONS OF THE PANEL AND ORDER THE NECESSARY EXTENSION



795004



025002

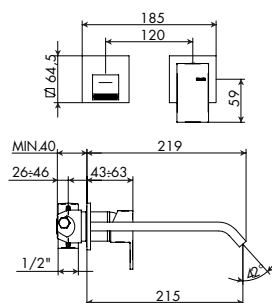
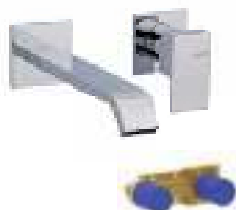

## 7905/3/BL/E + 894001 | B-DUE

MISCELATORE LAVABO DA PARETE BOCCA PROLUNGATA  
WALL BASIN EXTENDED SPOUT MIXER

- > cartuccia tradizionale
- > interasse bocca 215
- > ingressi da 1/2"
- > senza scarico
- > rosoni separati



## PARTI ESTERNE - CROMATO

01-7905/3/BL/E

## PARTE INCASSO

01-894001 info pag. 30

## PREZZO TOTALE

## PARTI ESTERNE - ALTRE FINITURE

XX-7905/3/BL/E x M\*



PER INSTALLAZIONI SU PARETI IN CARTONGESSO VERIFICARE LE DIMENSIONI DEL PANNELLO E ORDINARE LA NECESSARIA PROLUNGA  
FOR INSTALLATIONS ON DRYWALL, CHECK THE DIMENSIONS OF THE PANEL AND ORDER THE NECESSARY EXTENSION

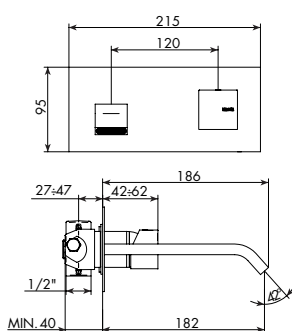

## 7905/3/E + 894001 | B-UNO

MISCELATORE LAVABO DA PARETE SU PIASTRA  
WALL BASIN MIXER ON PLATE

- > cartuccia tradizionale
- > interasse bocca 182
- > ingressi da 1/2"
- > senza scarico
- > piastra unica



## PARTI ESTERNE - CROMATO

01-7905/3/E

## PARTE INCASSO

01-894001 info pag. 30

## PREZZO TOTALE

## PARTI ESTERNE - ALTRE FINITURE

XX-7905/3/E x M\*



PER INSTALLAZIONI SU PARETI IN CARTONGESSO VERIFICARE LE DIMENSIONI DEL PANNELLO E ORDINARE LA NECESSARIA PROLUNGA  
FOR INSTALLATIONS ON DRYWALL, CHECK THE DIMENSIONS OF THE PANEL AND ORDER THE NECESSARY EXTENSION

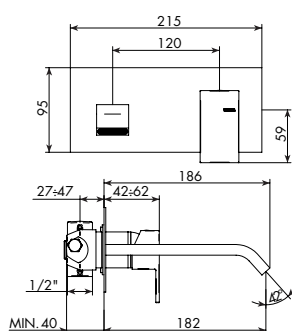

## 7905/3L/E + 894001 | B-DUE

MISCELATORE LAVABO DA PARETE SU PIASTRA  
WALL BASIN MIXER ON PLATE

- > cartuccia tradizionale
- > interasse bocca 182
- > ingressi da 1/2"
- > senza scarico
- > piastra unica



## PARTI ESTERNE - CROMATO

01-7905/3L/E

## PARTE INCASSO

01-894001 info pag. 30

## PREZZO TOTALE

## PARTI ESTERNE - ALTRE FINITURE

XX-7905/3L/E x M\*



PER INSTALLAZIONI SU PARETI IN CARTONGESSO VERIFICARE LE DIMENSIONI DEL PANNELLO E ORDINARE LA NECESSARIA PROLUNGA  
FOR INSTALLATIONS ON DRYWALL, CHECK THE DIMENSIONS OF THE PANEL AND ORDER THE NECESSARY EXTENSION

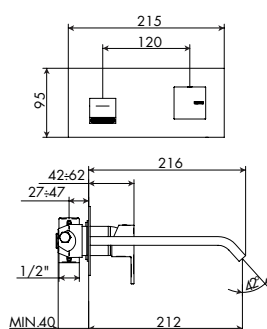

## 7905/3/1/E + 894001 | B-UNO

MISCELATORE LAVABO DA PARETE BOCCA PROLUNGATA SU PIASTRA  
WALL BASIN MIXER EXTENDED SPOUT ON PLATE

- > cartuccia tradizionale
- > interasse bocca 212
- > ingressi da 1/2"
- > senza scarico
- > piastra unica



## PARTI ESTERNE - CROMATO

01-7905/3/1/E

## PARTE INCASSO

01-894001 info pag. 30

## PREZZO TOTALE

## PARTI ESTERNE - ALTRE FINITURE

XX-7905/3/1/E x M\*



PER INSTALLAZIONI SU PARETI IN CARTONGESSO VERIFICARE LE DIMENSIONI DEL PANNELLO E ORDINARE LA NECESSARIA PROLUNGA  
FOR INSTALLATIONS ON DRYWALL, CHECK THE DIMENSIONS OF THE PANEL AND ORDER THE NECESSARY EXTENSION

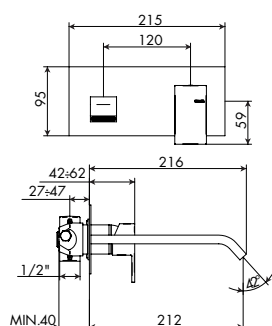

## 7905/3/1L/E + 894001 | B-DUE

MISCELATORE LAVABO DA PARETE BOCCA PROLUNGATA SU PIASTRA  
WALL BASIN MIXER EXTENDED SPOUT ON PLATE

- > cartuccia tradizionale
- > interasse bocca 212
- > ingressi da 1/2"
- > senza scarico
- > piastra unica



6536/U p. 884



6533 p. 879

## PARTI ESTERNE - CROMATO

01-7905/3/1L/E

## PARTE INCASSO

01-894001 info pag. 30

## PREZZO TOTALE

## PARTI ESTERNE - ALTRE FINITURE

XX-7905/3/1L/E

x M\*



PER INSTALLAZIONI SU PARETI IN CARTONGESSO VERIFICARE LE DIMENSIONI DEL PANNELLO E ORDINARE LA NECESSARIA PROLUNGA  
FOR INSTALLATIONS ON DRYWALL, CHECK THE DIMENSIONS OF THE PANEL AND ORDER THE NECESSARY EXTENSION



795004



025002

## 7705/R/A | B-UNO

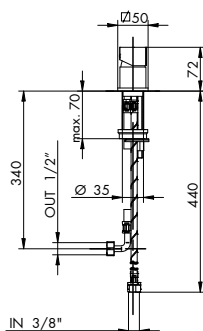
MISCELATORE REMOTO  
REMOTE MIXER

- > cartuccia tradizionale
- > flessibili di alimentazione
- > senza scarico



6536/U p. 884



6533 p. 879

## CROMATO

01-7705/R/A

## ALTRE FINITURE

XX-7705/R/A

x M\*



025002

## 7905/R/AL | B-DUE

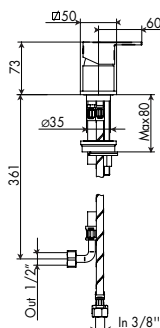
MISCELATORE REMOTO  
REMOTE MIXER

- > cartuccia tradizionale
- > flessibili di alimentazione
- > senza scarico



6536/U p. 884



6533 p. 879

## CROMATO

01-7905/R/AL

## ALTRE FINITURE

XX-7905/R/AL

x M\*



025002

## 7705/R/B/E + 104033 | B-UNO

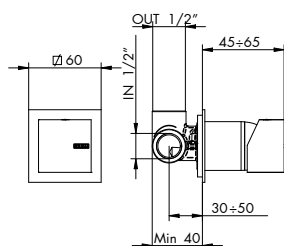
MISCELATORE INCASSO REMOTO  
BUILT-IN REMOTE MIXER

- > cartuccia tradizionale
- > ingressi da 1/2"
- > uscita superiore
- > senza scarico
- > utilizzabile anche come incasso doccia



6536/U p. 884



6533 p. 879

## PARTI ESTERNE - CROMATO

01-7705/R/B/E

## PARTE INCASSO

104033 info pag. 27

## PREZZO TOTALE

## PARTI ESTERNE - ALTRE FINITURE

XX-7705/R/B/E

x M\*



PER INSTALLAZIONI SU PARETI IN CARTONGESSO VERIFICARE LE DIMENSIONI DEL PANNELLO E ORDINARE LA NECESSARIA PROLUNGA  
FOR INSTALLATIONS ON DRYWALL, CHECK THE DIMENSIONS OF THE PANEL AND ORDER THE NECESSARY EXTENSION



025002

## 7905/R/BL/E + 104033 | B-DUE

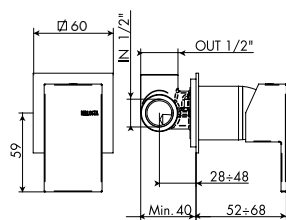
MISCELATORE INCASSO REMOTO  
BUILT-IN REMOTE MIXER

- > cartuccia tradizionale
- > ingressi da 1/2"
- > uscita superiore
- > senza scarico
- > utilizzabile anche come incasso doccia



6536/U p. 884



6533 p. 879

## PARTI ESTERNE - CROMATO

01-7905/R/BL/E

## PARTE INCASSO

01-104033 info pag. 27

## PREZZO TOTALE

## PARTI ESTERNE - ALTRE FINITURE

XX-7905/R/BL/E x M\*



PER INSTALLAZIONI SU PARETI IN CARTONGESSO VERIFICARE LE DIMENSIONI DEL PANNELLO E ORDINARE LA NECESSARIA PROLUNGA  
FOR INSTALLATIONS ON DRYWALL, CHECK THE DIMENSIONS OF THE PANEL AND ORDER THE NECESSARY EXTENSION



025002

## 104009 | 104010 | 104011

KIT PROLUNGA MIX INCASSO  
BUILT-IN MIXER EXTENSION KIT

- > lunghezza 2 cm, 3 cm, 4 cm
- > kit fondello prolunga cartuccia miscelatore + bicchiere esterno sostitutivo in finitura
- > per art. 7905/R/B/E, 7905/R/BL/E, 7905/3/A/E, 7905/3/AL/E, 7905/3/B/E, 7905/3/BL/E, 7905/3/E, 7905/3/L/E, 7905/3/1/E, 7905/3/1L/E

## CROMATO

01-104009

2 cm

01-104010

3 cm

01-104011

4 cm

## ALTRE FINITURE

XX-104009 2 cm

x M\*

XX-104010 3 cm

x M\*

XX-104011 4 cm

x M\*

- \* MOLTIPLICATORE RICAMBI
- \* MULTIPLIER "RICAMBI"

## 794004 | 794005

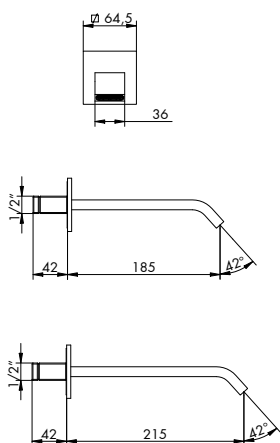
BOCCA LAVABO DA PARETE  
WALL BASIN SPOUT

- > interasse bocca 180 / 210
- > attacco da 1/2"
- > rosone quadro



6536/U p. 884



6533 p. 879

## CROMATO

01-794004

180 mm

01-794005

210 mm

## ALTRE FINITURE

XX-794004 180 mm

x M\*

XX-794005 210 mm

x M\*

- \* MOLTIPLICATORE RICAMBI
- \* MULTIPLIER "RICAMBI"

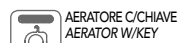

795004

## 7907 | B-UNO

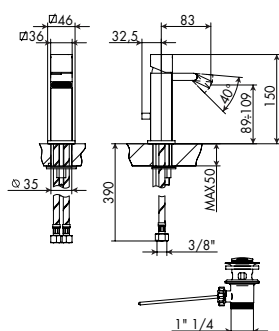
MISCELATORE BIDET MONOFORO  
BIDET MIXER

- > cartuccia tradizionale
- > interasse bocca 83
- > aeratore snodato
- > flessibili di alimentazione
- > con scarico



011/B p. 887

## CROMATO

01-7907

## ALTRE FINITURE

XX-7907

x M\*



795004



735005

**7907/L | B-DUE**

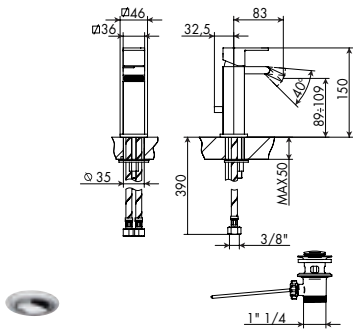

**MISCELATORE BIDET MONOFORO**

**BIDET MIXER**

- > cartuccia tradizionale
- > interasse bocca 83
- > aeratore snodato
- > flessibili di alimentazione
- > con scarico



011/B p. 887

**CROMATO**

01-7907/L

**ALTRE FINITURE**

XX-7907/L

x M\*



AERATORE C/CHIAVE  
AERATOR W/KEY

795004



CARTUCCIA  
CARTRIDGE

735005

**7907/S | B-UNO**

NEW

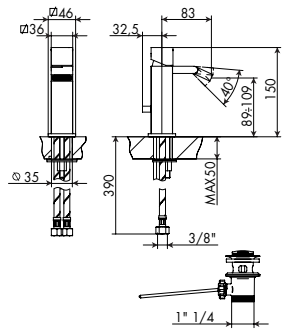

**MISCELATORE BIDET MONOFORO**

**BIDET MIXER**

- > cartuccia tradizionale
- > interasse bocca 83
- > aeratore snodato
- > flessibili di alimentazione
- > con scarico



SCARICO BIDET  
BIDET VASTE

6536/U p. 884



SIFONE  
SIPHON

011/B p. 887

**CROMATO**

01-7907/S

**ALTRE FINITURE**

XX-7907/S

x M\*



AERATORE C/CHIAVE  
AERATOR W/KEY

795004



CARTUCCIA  
CARTRIDGE

735005

**7907/SL | B-DUE**

NEW

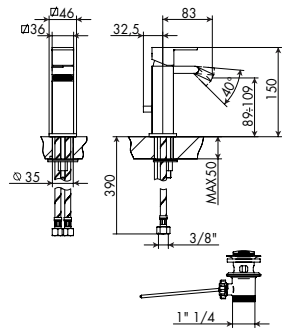

**MISCELATORE BIDET MONOFORO**

**BIDET MIXER**

- > cartuccia tradizionale
- > interasse bocca 83
- > aeratore snodato
- > flessibili di alimentazione
- > con scarico



SCARICO BIDET  
BIDET VASTE

6536/U p. 884



SIFONE  
SIPHON

011/B p. 887

**CROMATO**

01-7907/SL

**ALTRE FINITURE**

XX-7907/SL

x M\*



AERATORE C/CHIAVE  
AERATOR W/KEY

795004



CARTUCCIA  
CARTRIDGE

735005

**7721/E + 104018 | B-UNO**



INCASSO  
UNIVERSALE  
CON B-BOX

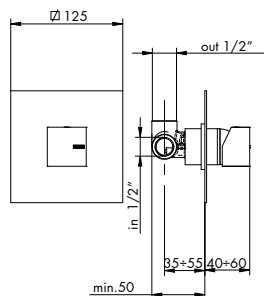

**MISCELATORE INCASSO**

**BUILT-IN MIXER**

- > cartuccia tradizionale
- > attacchi da 1/2"
- > uscita superiore
- > incasso con B-BOX



PILETTA DOCCIA  
SHOWER WASTE

8816/E + 775025  
p. 888

**PARTI ESTERNE - CROMATO**

01-7721/E

**PARTI ESTERNE - ALTRE FINITURE**

XX-7721/E

x M\*

**PARTE INCASSO**

01-104018 info pag. 32

**PREZZO TOTALE**



PER INSTALLAZIONI SU PARETI IN CARTONGESSO VERIFICARE LE DIMENSIONI DEL PANNELLO E ORDINARE LA NECESSARIA PROLUNGA  
FOR INSTALLATIONS ON DRYWALL, CHECK THE DIMENSIONS OF THE PANEL AND ORDER THE NECESSARY EXTENSION



CARTUCCIA  
CARTRIDGE

025002

## 7921/L/E + 104018 | B-DUE



INCASSO  
UNIVERSALE  
CON B-BOX

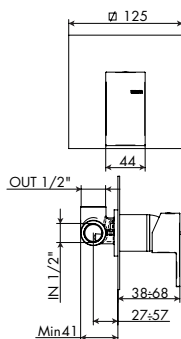

## MISCELATORE INCASSO

## BUILT-IN MIXER

- > cartuccia tradizionale
- > attacchi da 1/2"
- > uscita superiore
- > incasso con B-BOX



PILETTA DOCCIA  
SHOWER WASTE

8816/E + 775025  
p. 888

## PARTI ESTERNE - CROMATO

01-7921/L/E

## PARTE INCASSO

01-104018 info pag. 32

## PREZZO TOTALE

## PARTI ESTERNE - ALTRE FINITURE

XX-7921/L/E

x M\*



PER INSTALLAZIONI SU PARETI IN CARTONGESSO VERIFICARE LE DIMENSIONI DEL PANNELLO E ORDINARE LA NECESSARIA PROLUNGA  
FOR INSTALLATIONS ON DRYWALL, CHECK THE DIMENSIONS OF THE PANEL AND ORDER THE NECESSARY EXTENSION



CARTUCCIA  
CARTRIDGE

025002

## 104009 | 104010 | 104011



## KIT PROLUNGA MIX INCASSO

## BUILT-IN MIXER EXTENSION KIT

- > lunghezza 2 cm, 3 cm, 4 cm
- > kit fondello prolunga cartuccia miscelatore + bicchiere esterno sostitutivo in finitura
- > per art.: 7721/E, 7921/L/E

## CROMATO

01-104009 2 cm  
01-104010 3 cm  
01-104011 4 cm

## ALTRE FINITURE

XX-104009 2 cm x M\*  
XX-104010 3 cm x M\*  
XX-104011 4 cm x M\*

\* MOLTIPLICATORE RICAMBI  
\* MULTIPLIER "RICAMBI"

## 7700/E + 104002 | B-UNO



INCASSO  
UNIVERSALE  
CON B-BOX

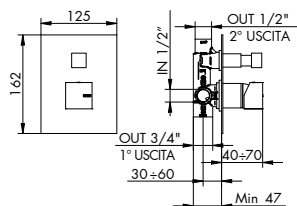

## MISCELATORE INCASSO C/DEVIATORE AUTOMATICO 2 USCITE

## BUILT-IN MIXER WITH AUTOMATIC DIVERTER 2 OUT

- > cartuccia tradizionale
- > deviatore a pressione 2 uscite c/ritorno automatico e blocco meccanico basse pressioni
- > attacchi da 1/2"
- > uscita principale inferiore da 3/4"
- > incasso con B-BOX



PILETTA DOCCIA  
SHOWER WASTE

8816/E + 775025  
p. 888

## PARTI ESTERNE - CROMATO

01-7700/E

## PARTE INCASSO

01-104002 info pag. 33

## PREZZO TOTALE

## PARTI ESTERNE - ALTRE FINITURE

XX-7700/E

x M\*



PER INSTALLAZIONI SU PARETI IN CARTONGESSO VERIFICARE LE DIMENSIONI DEL PANNELLO E ORDINARE LA NECESSARIA PROLUNGA  
FOR INSTALLATIONS ON DRYWALL, CHECK THE DIMENSIONS OF THE PANEL AND ORDER THE NECESSARY EXTENSION



DEVIATORE  
DIVERTER

105029



CARTUCCIA  
CARTRIDGE

025002

## 7900/L/E + 104002 | B-DUE



INCASSO  
UNIVERSALE  
CON B-BOX

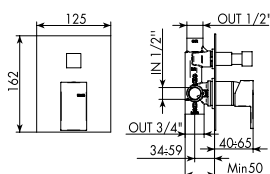

## MISCELATORE INCASSO C/DEVIATORE AUTOMATICO 2 USCITE

## BUILT-IN MIXER WITH AUTOMATIC DIVERTER 2 OUT

- > cartuccia tradizionale
- > deviatore a pressione 2 uscite c/ritorno automatico e blocco meccanico basse pressioni
- > attacchi da 1/2"
- > uscita principale inferiore da 3/4"
- > incasso con B-BOX



PILETTA DOCCIA  
SHOWER WASTE

8816/E + 775025  
p. 888

## PARTI ESTERNE - CROMATO

01-7900/L/E

## PARTE INCASSO

01-104002 info pag. 33

## PREZZO TOTALE

## PARTI ESTERNE - ALTRE FINITURE

XX-7900/L/E

x M\*



PER INSTALLAZIONI SU PARETI IN CARTONGESSO VERIFICARE LE DIMENSIONI DEL PANNELLO E ORDINARE LA NECESSARIA PROLUNGA  
FOR INSTALLATIONS ON DRYWALL, CHECK THE DIMENSIONS OF THE PANEL AND ORDER THE NECESSARY EXTENSION



DEVIATORE  
DIVERTER

105029



CARTUCCIA  
CARTRIDGE

025002

## 7900/1/P/E + 724027 | B-UNO

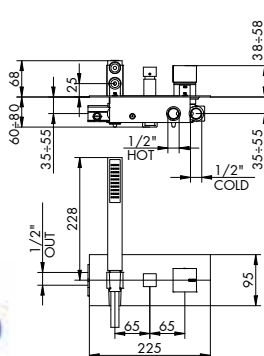

INCASSO  
UNIVERSALE

**MISCELATORE INCASSO C/DEVIATORE AUTOMATICO E DOCCETTA**  
**BUILT-IN MIXER WITH AUTOMATIC DIVERTER AND HAND SHOWER**

- > cartuccia tradizionale
- > deviatore a pressione 2 uscite c/ritorno automatico e blocco meccanico basse pressioni
- > attacchi da 1/2"
- > flessibile in PVC 150 cm
- > doccia monogetto quadra in ABS c/anticalcare
- > per finiture diverse da cromo doccia in metallo



PILETTA DOCCIA  
SHOWER WASTE

8816/E + 775025  
p. 888

## PARTI ESTERNE - CROMATO

01-7900/1/P/E

## PARTI ESTERNE - ALTRE FINITURE

XX-7900/1/P/E

x M\*

## PARTE INCASSO

01-724027 info pag. 35

## PREZZO TOTALE

PER INSTALLAZIONI SU PARETI IN CARTONGESSO VERIFICARE LE DIMENSIONI DEL PANNELLO E ORDINARE LA NECESSARIA PROLUNGA  
FOR INSTALLATIONS ON DRYWALL, CHECK THE DIMENSIONS OF THE PANEL AND ORDER THE NECESSARY EXTENSION

DEVIATORE  
DIVERTER

724030

CARTUCCIA  
CARTRIDGE

025002

## 7900/1/PL/E + 724027 | B-DUE

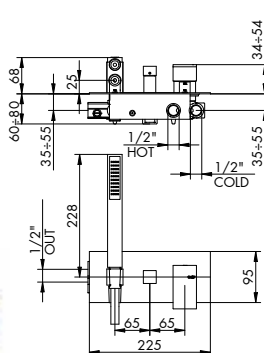

INCASSO  
UNIVERSALE

**MISCELATORE INCASSO C/DEVIATORE AUTOMATICO E DOCCETTA**  
**BUILT-IN MIXER WITH AUTOMATIC DIVERTER AND HAND SHOWER**

- > cartuccia tradizionale
- > deviatore a pressione 2 uscite c/ritorno automatico e blocco meccanico basse pressioni
- > attacchi da 1/2"
- > flessibile in PVC 150 cm
- > uscita principale fianco sinistro
- > doccia monogetto quadra in ABS c/anticalcare
- > per finiture diverse da cromo doccia in metallo

PILETTA DOCCIA  
SHOWER WASTE

8816/E + 775025  
p. 888

## PARTI ESTERNE - CROMATO

01-7900/1/PL/E

## PARTI ESTERNE - ALTRE FINITURE

XX-7900/1/PL/E

x M\*

## PARTE INCASSO

01-724027 info pag. 35

## PREZZO TOTALE

PER INSTALLAZIONI SU PARETI IN CARTONGESSO VERIFICARE LE DIMENSIONI DEL PANNELLO E ORDINARE LA NECESSARIA PROLUNGA  
FOR INSTALLATIONS ON DRYWALL, CHECK THE DIMENSIONS OF THE PANEL AND ORDER THE NECESSARY EXTENSION

DEVIATORE  
DIVERTER

724030

CARTUCCIA  
CARTRIDGE

025002

## 104006 | 104007 | 104008

**KIT PROLUNGA MIX INCASSO CON DEVIAZIONE**  
**BUILT-IN MIXER EXTENSION KIT WITH DIVERTER**

- > lunghezza 2 cm, 3 cm, 4 cm
- > kit fondello prolunga cartuccia miscelatore e albero deviatore + bicchieri esterni sostitutivi in finitura
- > per art.: 7700/E, 7900/L/E, 7900/1/P/E, 7900/1/PL/E

## CROMATO

01-104006 2 cm  
01-104007 3 cm  
01-104008 4 cm

## ALTRE FINITURE

XX-104006 2 cm x M\*  
XX-104007 3 cm x M\*  
XX-104008 4 cm x M\*

\* MOLTIPLICATORE RICAMBI  
\* MULTIPLIER "RICAMBI"

## 7703/2/1/E + 914016 | B-UNO

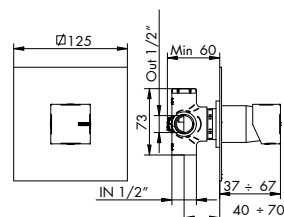
**DEVIATORE INCASSO 2 USCITE**  
**BUILT-IN DIVERTER 2 OUT**

- > deviatore a dischi ceramici 2 uscite senza chiusura
- > attacchi da 1/2"
- > abbinare a miscelatore o rubinetti d'arresto

## PARTI ESTERNE - CROMATO

01-7703/2/1/E

## PARTI ESTERNE - ALTRE FINITURE

XX-7703/2/1/E

x M\*

## PARTE INCASSO

914016 info pag. 36

## PREZZO TOTALE

CARTUCCIA  
DEVIATRICE  
DIVERTER CARTRIDGE

035346 ante 9.2017

CARTUCCIA  
DEVIATRICE  
DIVERTER CARTRIDGE

635010

**7903/2/1L/E + 914016 | B-DUE**

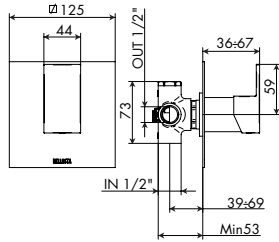

**DEVIATORE INCASSO 2 USCITE**  
**BUILT-IN DIVERTER 2 OUT**

- > deviatore a dischi ceramici 2 uscite senza chiusura
- > attacchi da 1/2"
- > abbinare a miscelatore o rubinetti d'arresto

**PARTI ESTERNE - CROMATO**

01-7903/2/1L/E

**PARTE INCASSO**

914016 info pag. 36

**PREZZO TOTALE**

**PARTI ESTERNE - ALTRE FINITURE**

**XX-7903/2/1L/E** x M\*



CARTUCCIA  
DEVIATRICE  
DIVERTER CARTRIDGE



CARTUCCIA  
DEVIATRICE  
DIVERTER CARTRIDGE

035346 ante 9.2017 635010

**7703/3/1/E + 034127 | B-UNO**

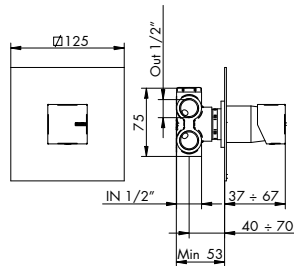

**DEVIATORE INCASSO 3 USCITE**  
**BUILT-IN DIVERTER 3 OUT**

- > deviatore a dischi ceramici 3 uscite senza chiusura
- > attacchi da 1/2"
- > abbinare a miscelatore o rubinetti d'arresto

**PARTI ESTERNE - CROMATO**

01-7703/3/1/E

**PARTE INCASSO**

034127 info pag. 36

**PREZZO TOTALE**

**PARTI ESTERNE - ALTRE FINITURE**

**XX-7703/3/1/E** x M\*



CARTUCCIA  
DEVIATRICE  
DIVERTER CARTRIDGE



CARTUCCIA  
DEVIATRICE  
DIVERTER CARTRIDGE

035345 ante 9.2017 635011

**7903/3/1L/E + 034127 | B-DUE**

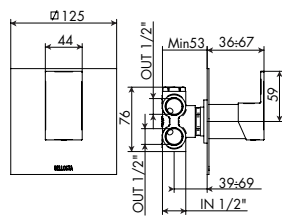

**DEVIATORE INCASSO 3 USCITE**  
**BUILT-IN DIVERTER 3 OUT**

- > deviatore a dischi ceramici 3 uscite senza chiusura
- > attacchi da 1/2"
- > abbinare a miscelatore o rubinetti d'arresto

**PARTI ESTERNE - CROMATO**

01-7903/3/1L/E

**PARTE INCASSO**

034127 info pag. 36

**PREZZO TOTALE**

**PARTI ESTERNE - ALTRE FINITURE**

**XX-7903/3/1L/E** x M\*



CARTUCCIA  
DEVIATRICE  
DIVERTER CARTRIDGE



CARTUCCIA  
DEVIATRICE  
DIVERTER CARTRIDGE

035345 ante 9.2017 635011

**7703/4/1/E + 034128 | B-UNO**

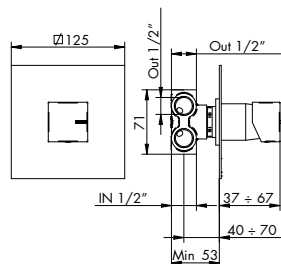

**DEVIATORE INCASSO 4 USCITE**  
**BUILT-IN DIVERTER 4 OUT**

- > deviatore a dischi ceramici 4 uscite senza chiusura
- > attacchi da 1/2"
- > abbinare a miscelatore o rubinetti d'arresto

**PARTI ESTERNE - CROMATO**

01-7703/4/1/E

**PARTE INCASSO**

034128 info pag. 36

**PREZZO TOTALE**

**PARTI ESTERNE - ALTRE FINITURE**

**XX-7703/4/1/E** x M\*



CARTUCCIA  
DEVIATRICE  
DIVERTER CARTRIDGE



CARTUCCIA  
DEVIATRICE  
DIVERTER CARTRIDGE

035344 ante 9.2017 635012

7903/4/1L/E + 034128 | B-DUE

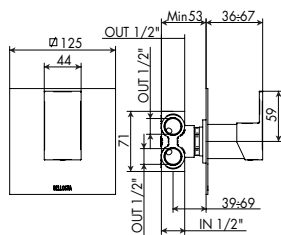

DEVIATORE INCASSO 4 USCITE

BUILT-IN DIVERTER 4 OUT

- > deviatore a dischi ceramici 4 uscite senza chiusura
- > attacchi da 1/2"
- > abbinare a miscelatore o rubinetti d'arresto

PARTI ESTERNE - CROMATO

01-7903/4/1L/E

PARTE INCASSO

034128 info pag. 36

PREZZO TOTALE

PARTI ESTERNE - ALTRE FINITURE

XX-7903/4/1L/E

x M\*



CARTUCCIA DEVIATRICE  
DIVERTER CARTRIDGE

035344 ante 9.2017



CARTUCCIA DEVIATRICE  
DIVERTER CARTRIDGE

635012

0912/H/P/E + 484020



INCASSO UNIVERSALE CON B-BOX

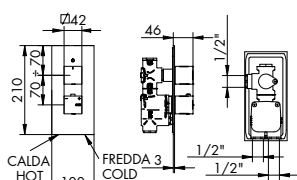

MISCELATORE TERMOSTATICO INCASSO 1 USCITA

BUILT-IN THERMOSTATIC MIXER 1 OUT

- > cartuccia termostatica
- > vitone ceramico 90°
- > apertura con rotazione antioraria
- > ingressi inferiori da 1/2"
- > incasso con B-BOX
- > posizionabile orizzontalmente
- > interasse 70 mm
- > uscite laterali destra da 1/2"
- > incasso regolabile min 76



PILETTA DOCCIA  
SHOWER WASTE

8816/E + 775025  
p. 888

PARTI ESTERNE - CROMATO

01-0912/H/P/E

PARTE INCASSO

484020 info pag. 37

PREZZO TOTALE

PER INSTALLAZIONI SU PARETI IN CARTONGESSO VERIFICARE LE DIMENSIONI DEL PANNELLO E ORDINARE LA NECESSARIA PROLUNGA  
FOR INSTALLATIONS ON DRYWALL, CHECK THE DIMENSIONS OF THE PANEL AND ORDER THE NECESSARY EXTENSION

PARTI ESTERNE - ALTRE FINITURE

XX-0912/H/P/E

x M\*

\* MOLTIPLICATORE COMANDI QUADRO  
\* MULTIPLIER "COMANDI QUADRO"



VITONE CERAMICO  
CERAMIC VALVE

055134



CART. TERMOSTATICA  
THERMOSTATIC CARTRIDGE

775007

0912/2/P/E + 484021



INCASSO UNIVERSALE CON B-BOX

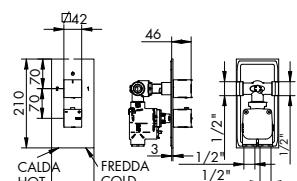

MISCELATORE TERMOSTATICO INCASSO C/DEVIATORE 2 USCITE

BUILT-IN THERMOSTATIC MIXER WITH DIVERTER 2 OUT

- > cartuccia termostatica
- > deviatore a dischi ceramici 2 uscite c/chiusura
- > interasse 70 mm
- > ingressi inferiori da 1/2"
- > incasso con B-BOX
- > uscite laterali da 1/2"
- > incasso regolabile min 76



PILETTA DOCCIA  
SHOWER WASTE

8816/E + 775025  
p. 888

PARTI ESTERNE - CROMATO

01-0912/2/P/E

PARTE INCASSO

484021 info pag. 37

PREZZO TOTALE

PER INSTALLAZIONI SU PARETI IN CARTONGESSO VERIFICARE LE DIMENSIONI DEL PANNELLO E ORDINARE LA NECESSARIA PROLUNGA  
FOR INSTALLATIONS ON DRYWALL, CHECK THE DIMENSIONS OF THE PANEL AND ORDER THE NECESSARY EXTENSION

PARTI ESTERNE - ALTRE FINITURE

XX-0912/2/P/E

x M\*

\* MOLTIPLICATORE COMANDI QUADRO  
\* MULTIPLIER "COMANDI QUADRO"



CARTUCCIA DEVIATRICE  
DIVERTER CARTRIDGE

035346



CART. TERMOSTATICA  
THERMOSTATIC CARTRIDGE

775007

0912/3/P/E + 484022



INCASSO UNIVERSALE CON B-BOX

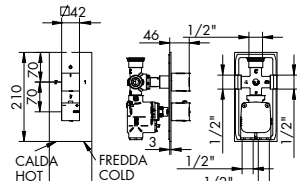

MISCELATORE TERMOSTATICO INCASSO C/DEVIATORE 3 USCITE

BUILT-IN THERMOSTATIC MIXER WITH DIVERTER 3 OUT

- > cartuccia termostatica
- > deviatore a dischi ceramici 3 uscite c/chiusura
- > interasse 70 mm
- > ingressi inferiori da 1/2"
- > incasso con B-BOX
- > uscite laterali e superiore da 1/2"
- > incasso regolabile min 76



PILETTA DOCCIA  
SHOWER WASTE

8816/E + 775025  
p. 888

PARTI ESTERNE - CROMATO

01-0912/3/P/E

PARTE INCASSO

484022 info pag. 37

PREZZO TOTALE

PER INSTALLAZIONI SU PARETI IN CARTONGESSO VERIFICARE LE DIMENSIONI DEL PANNELLO E ORDINARE LA NECESSARIA PROLUNGA  
FOR INSTALLATIONS ON DRYWALL, CHECK THE DIMENSIONS OF THE PANEL AND ORDER THE NECESSARY EXTENSION

PARTI ESTERNE - ALTRE FINITURE

XX-0912/3/P/E

x M\*

\* MOLTIPLICATORE COMANDI QUADRO  
\* MULTIPLIER "COMANDI QUADRO"



CARTUCCIA DEVIATRICE  
DIVERTER CARTRIDGE

035345



CART. TERMOSTATICA  
THERMOSTATIC CARTRIDGE

775007



0912/4/P/E + 484023



INCASSO UNIVERSALE CON B-BOX

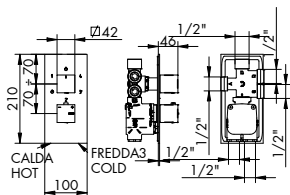

MISCELATORE TERMOSTATICO INCASSO C/DEVIATORE 4 USCITE  
BUILT-IN THERMOSTATIC MIXER WITH DIVERTER 4 OUT

- > cartuccia termostatica
- > deviatore a dischi ceramici 4 uscite c/doppia chiusura
- > interasse 70 mm
- > ingressi inferiori da 1/2"
- > incasso con B-Box
- > uscite laterali e superiore da 1/2"
- > incasso regolabile min 76

PILETTA DOCCIA SHOWER WASTE  
8816/E + 775025  
p. 888

PARTI ESTERNE - CROMATO

01-0912/4/P/E

PARTE INCASSO

484023 info pag. 38

PREZZO TOTALE

PARTI ESTERNE - ALTRE FINITURE

XX-0912/4/P/E x M\*

- \* MOLTIPLICATORE COMANDI QUADRO
- \* MULTIPLIER "COMANDI QUADRO"



PER INSTALLAZIONI SU PARETI IN CARTONGESSO VERIFICARE LE DIMENSIONI DEL PANNELLO E ORDINARE LA NECESSARIA PROLUNGA  
FOR INSTALLATIONS ON DRYWALL, CHECK THE DIMENSIONS OF THE PANEL AND ORDER THE NECESSARY EXTENSION

CARTUCCIA DEVIATRICE DIVERTER CARTRIDGE  
035344

CART. TERMOSTATICA THERMOSTATIC CARTRIDGE  
775007

094021 | 094025



KIT PROLUNGA MIX INCASSO TERMOSTATICO  
BUILT-IN THERMOSTATIC MIXER EXTENSION KIT

- > lunghezza 3 cm
- > 094021 per art. 0912/2/P/E, 0912/3/P/E, 0912/4/P/E
- > 094025 per art. 0912/H/P/E

GREZZO

094021 2/3/4 out

094025 1 out

PER COMANDI TERMOSTATICI ALTA PORTATA, CONSULTARE SEZIONE REVIVRE DA PAG. 346.

FOR HIGH FLOW RATE THERMOSTATIC MIXER, LOOK AT THE "REVIVRE" COLLECTION FROM PAGE 346.

0912/H/P/E + 774035	0912/2H/P/E + 774036	0912/3H/P/E + 774033	0912/4H/P/E + 774034	0912/H/E + 884036	0912/2H/E + 884037	0912/3H/E + 884038	0912/4H/E + 884039
1 OUT ALTA PORTATA HIGH FLOW RATE	2 OUT ALTA PORTATA HIGH FLOW RATE	3 OUT ALTA PORTATA HIGH FLOW RATE	4 OUT ALTA PORTATA HIGH FLOW RATE	1 OUT ALTA PORTATA HIGH FLOW RATE	2 OUT ALTA PORTATA HIGH FLOW RATE	3 OUT ALTA PORTATA HIGH FLOW RATE	4 OUT ALTA PORTATA HIGH FLOW RATE

7709/1 | B-UNO

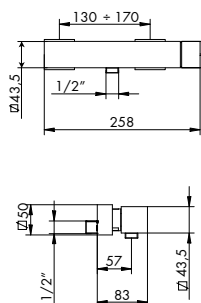

MISCELATORE DOCCIA ESTERNO  
EXTERNAL SHOWER MIXER

- > cartuccia tradizionale
- > senza set doccia
- > attacchi da 1/2"

PILETTA DOCCIA SHOWER WASTE  
8816/E + 775025  
p. 888

CROMATO

01-7709/1

ALTRE FINITURE

XX-7709/1 x M\*

CARTUCCIA CARTRIDGE  
025002

## 7909/1L | B-DUE

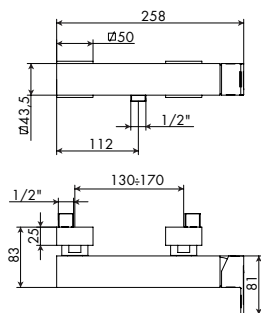
MISCELATORE DOCCIA ESTERNO  
EXTERNAL SHOWER MIXER

- > cartuccia tradizionale
- > senza set doccia
- > attacchi da 1/2"



8816/E + 775025  
p. 888

## CROMATO

01-7909/1L

## ALTRE FINITURE

XX-7909/1L

x M\*



025002

## DOCCIA COMPLEMENTI CONSIGLIATI:

PER SOLUZIONI ALTERNATIVE E LISTINO PREZZI, CONSULTARE LA SEZIONE COMPLETA, DA PAG. 118.

## SUGGESTED "DOCCIA COMPLEMENTI":

FOR ALTERNATIVE SOLUTIONS AND PRICE LIST, SEE THE COMPLETE COLLECTION FROM PAGE 118.



6503/1/A, 6503/1  
SUPPORTO DOCCIA COMPLETO  
FULL SHOWER SUPPORT



6530  
SALISCENDI COMPLETO C/PRESA D'ACQUA  
COMPLETE WALL PIPE WITH WATER CONNECTION



6513/4  
STELO DOCCIA  
ROD SHOWER



6513/5/1  
CURVA PRESA ACQUA C/STELO COMPLETO  
CURVE WATER CONNECTOR WITH COMPLETE ROD

## SOFFIONI E BRACCI CONSIGLIATI:

PER SOLUZIONI ALTERNATIVE E LISTINO PREZZI, CONSULTARE LA SEZIONE COMPLETA, DA PAG. 38.  
PER COMPOSIZIONI DOCCIA CONSULTARE SEZIONE REVIVRE.

## SUGGESTED "BRACCI E SOFFIONI":

FOR ALTERNATIVE SOLUTIONS AND PRICE LIST, SEE THE COMPLETE COLLECTION FROM PAGE 38.  
FOR SHOWER TYPESETTING LOOK AT "REVIVRE" COLLECTION.



125017  
SOFFIONE Ø 200 OTTONE  
BRASS CEILING DIAMETER 200



655177  
SOFFIONE Ø 300 OTTONE  
BRASS CEILING DIAMETER 300



754088  
BRACCIO DA PARETE MM 350  
WALL ARM MM 350



754086  
BRACCIO A SOFFITTO MM 250  
CEILING ARM MM 250

## COMPONI IL TUO SET DOCCIA:

PER SOLUZIONI ALTERNATIVE E LISTINO PREZZI, CONSULTARE LA SEZIONE COMPLETA, DA PAG. 186.

## DESIGN YOUR SHOWER SET:

FOR ALTERNATIVE SOLUTIONS AND PRICE LIST, SEE THE COMPLETE COLLECTION FROM PAGE 186.



654043  
GANCIO INCASSO FISSO  
BUILT-IN FIXED HOOK



654044  
SUPPORTO ESTERNO FISSO  
EXTERNAL FIXED SUPPORT



655197 OTTONE  
DOCCETTA MONOGETTO  
MONO JET HAND SHOWER



915003  
FLESSIBILE TUBO PVC L150 CM  
PVC TUBE FLEXIBLE L150 CM



655016  
FLESSIBILE TRECCIA OTTONE L150 CM  
BRASS FLEXIBLE L150 CM



6530/1  
ASTA SALISCENDI  
WALL PIPE



7901/20/A | B-UNO

MISCELATORE PER BORDO VASCA S/BOCCA  
BATH RIM MIXER WITHOUT SPOUT

- > cartuccia tradizionale
- > senza bocca
- > deviatore a pressione c/ritorno automatico
- > flessibile in PVC 150 cm > flessibili di alimentazione
- > senza scarico
- > doccetta monogetto quadra in ABS c/anticalcare, per finiture diverse da cromo doccetta in metallo
- > OPTIONAL PREDISPOSIZIONI per bordo vasca, art. 012/3, 012/6 e 012/7, pag. 873/874

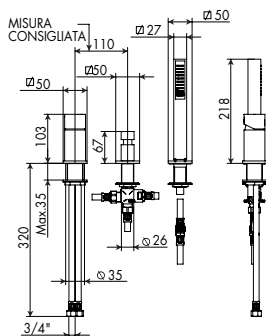

<b>CROMATO</b>	<b>ALTRE FINITURE</b>
01-7901/20/A	XX-7901/20/A x M*



7901/20/AL | B-DUE

MISCELATORE PER BORDO VASCA S/BOCCA  
BATH RIM MIXER WITHOUT SPOUT

- > cartuccia tradizionale
- > senza bocca
- > deviatore a pressione c/ritorno automatico
- > flessibile in PVC 150 cm > flessibili di alimentazione
- > senza scarico
- > doccetta monogetto quadra in ABS c/anticalcare, per finiture diverse da cromo doccetta in metallo
- > OPTIONAL PREDISPOSIZIONI per bordo vasca, art. 012/3, 012/6 e 012/7, pag. 873/874

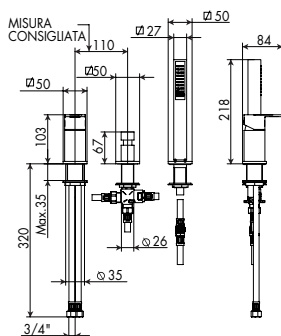

<b>CROMATO</b>	<b>ALTRE FINITURE</b>
01-7901/20/AL	XX-7901/20/AL x M*



7900/2/P/E + 724028 | B-UNO

MISCELATORE INCASSO C/DEVIATORE, DOCCETTA E BOCCA  
BUILT-IN MIXER WITH DIVERTER HAND SHOWER AND SPOUT

- > cartuccia tradizionale
- > Interasse bocca 182
- > deviatore a pressione 2 uscite c/ritorno automatico e blocco meccanico basse pressioni
- > attacchi da 1/2"
- > flessibile in PVC 150 cm
- > doccetta monogetto quadra in ABS c/anticalcare, per finiture diverse da cromo doccetta in metallo

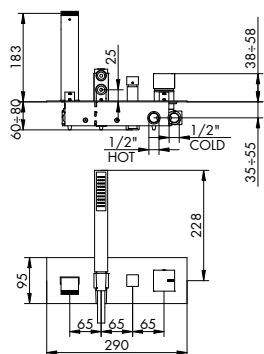

<b>PARTI ESTERNE - CROMATO</b>	<b>PARTI ESTERNE - ALTRE FINITURE</b>
01-7900/2/P/E	XX-7900/2/P/E x M*

**PARTE INCASSO**  
01-724028 info pag. 39

**PREZZO TOTALE**



**INCASSO UNIVERSALE**



PER INSTALLAZIONI SU PARETI IN CARTONGESSO VERIFICARE LE DIMENSIONI DEL PANNELLO E ORDINARE LA NECESSARIA PROLUNGA  
FOR INSTALLATIONS ON DRYWALL, CHECK THE DIMENSIONS OF THE PANEL AND ORDER THE NECESSARY EXTENSION



7900/2/PL/E + 724028 | B-DUE

MISCELATORE INCASSO C/DEVIATORE, DOCCETTA E BOCCA  
BUILT-IN MIXER WITH DIVERTER HAND SHOWER AND SPOUT

- > cartuccia tradizionale
- > Interasse bocca 182
- > deviatore a pressione 2 uscite c/ritorno automatico e blocco meccanico basse pressioni
- > attacchi da 1/2" > flessibile in PVC 150 cm
- > doccetta monogetto quadra in ABS c/anticalcare, per finiture diverse da cromo doccetta in metallo

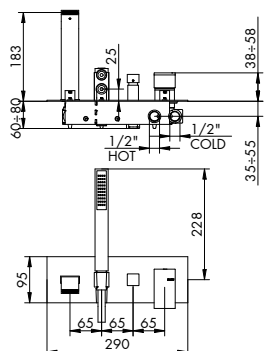

<b>PARTI ESTERNE - CROMATO</b>	<b>PARTI ESTERNE - ALTRE FINITURE</b>
01-7900/2/PL/E	XX-7900/2/PL/E x M*

**PARTE INCASSO**  
01-724028 info pag. 39

**PREZZO TOTALE**



**INCASSO UNIVERSALE**



PER INSTALLAZIONI SU PARETI IN CARTONGESSO VERIFICARE LE DIMENSIONI DEL PANNELLO E ORDINARE LA NECESSARIA PROLUNGA  
FOR INSTALLATIONS ON DRYWALL, CHECK THE DIMENSIONS OF THE PANEL AND ORDER THE NECESSARY EXTENSION



104006 | 104007 | 104008



**KIT PROLUNGA MIX INCASSO CON DEVIAZIONE**  
**BUILT-IN MIXER EXTENSION KIT WITH DIVERTER**

- > lunghezza 2 cm, 3 cm, 4 cm
- > kit fondello prolunga cartuccia miscelatore e albero deviatore
- + bicchieri esterni sostitutivi in finitura
- > per art.: 7900/2/P/E, 7900/2/PL/E

**CROMATO**

01-104006	2 cm
01-104007	3 cm
01-104008	4 cm

**ALTRE FINITURE**

XX-104006	2 cm
XX-104007	3 cm
XX-104008	4 cm

\* **MOLTIPLICATORE RICAMBI**  
 \* **MULTIPLIER "RICAMBI"**

7901/4/A/E + 734012 | B-UNO

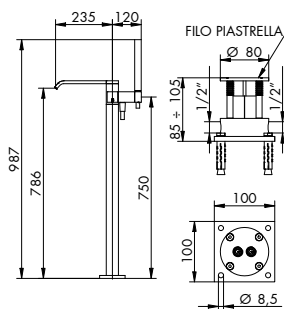

**MISCELATORE VASCA C/ATTACCHI A PAVIMENTO**  
**FLOOR BATH MIXER**

- > cartuccia tradizionale
- > Interasse bocca 205
- > deviatore a dischi ceramici a 2 uscite
- > flessibile in PVC 150 cm
- > gancio incorporato > parte incasso attacchi 1/2"
- > doccetta monogetto quadra in ABS c/anticalcare, per finiture diverse da cromo doccetta in metallo



012 p. 888

**PARTI ESTERNE - CROMATO**

01-7901/4/A/E

**PARTE INCASSO**

734012 info pag. 30

**PREZZO TOTALE**

**PARTI ESTERNE - ALTRE FINITURE**

XX-7901/4/A/E

x M\*



795005



755058



025002

7901/4/AL/E + 734012 | B-DUE

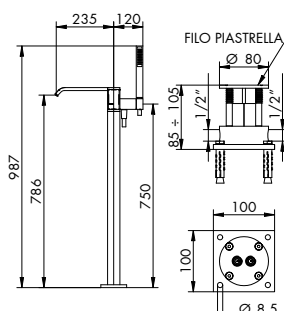

**MISCELATORE VASCA C/ATTACCHI A PAVIMENTO**  
**FLOOR BATH MIXER**

- > cartuccia tradizionale
- > Interasse bocca 235
- > deviatore a dischi ceramici a 2 uscite
- > flessibile in PVC 150 cm > gancio incorporato
- > parte incasso attacchi 1/2"
- > doccetta monogetto quadra in ABS c/anticalcare, per finiture diverse da cromo doccetta in metallo



012 p. 888

**PARTI ESTERNE - CROMATO**

01-7901/4/AL/E

**PARTE INCASSO**

734012 info pag. 30

**PREZZO TOTALE**

**PARTI ESTERNE - ALTRE FINITURE**

XX-7901/4/AL/E

x M\*



795005



755058



025002

7903 | B-UNO | B-DUE

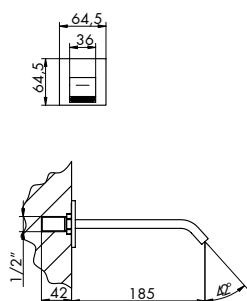

**BOCCA VASCA DA PARETE**  
**WALL BATH SPOUT**

- > interasse bocca 185
- > attacchi da 1/2"



012 p. 888

**CROMATO**

01-7903

**ALTRE FINITURE**

XX-7903

x M\*



795005

794026

NEW

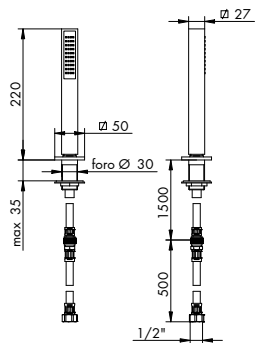

**SUPPORTO DOCCIA BV QUADRO COMPLETO**  
**COMPLETE SQUARE HAND SHOWER SET FOR BATH RIM**

- > flessibile in PVC 150 cm
- > attacco da 1/2"
- > doccetta monogetto cilindrica in ABS c/anticalcare 27x80, per finiture diverse da cromo doccetta in metallo

**CROMATO**  
 01-794026

**ALTRE FINITURE**  
 XX-794026 **x M^**

^ **MOLTIPLICATORE DOCCIA COMPLEMENTI**  
 ^ **MULTIPLIER "DOCCIA COMPLEMENTI"**

**7708/E + 054025 DX | B-UNO**

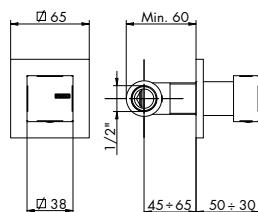

**RUBINETTO D'ARRESTO 1/2"**

**BUILT-IN STOP COCK 1/2"**

- > vitone ceramico 90°
- > ingressi da 1/2"

**PARTI ESTERNE - CROMATO**  
 01-7708/E

**PARTI ESTERNE - ALTRE FINITURE**  
 XX-7708/E **x M\***

**PARTE INCASSO**  
 054025 info pag. 40

**PREZZO TOTALE**



**7908/L/E + 054025 DX o 054026 SX | B-DUE**

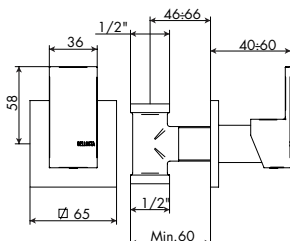

**RUBINETTO D'ARRESTO 1/2"**

**BUILT-IN STOP COCK 1/2"**

- > vitone ceramico 90°
- > ingressi da 1/2"

**PARTI ESTERNE - CROMATO**  
 01-7908/L/E

**PARTI ESTERNE - ALTRE FINITURE**  
 XX-7908/L/E **x M\***

**PARTE INCASSO**  
 054025 o 054026 info pag. 40

**PREZZO TOTALE**



**7708/E + 054027 DX | B-UNO**

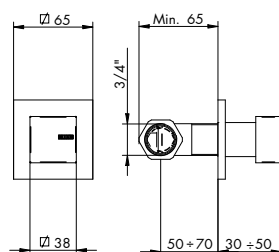

**RUBINETTO D'ARRESTO 3/4"**

**BUILT-IN STOP COCK 3/4"**

- > vitone ceramico 90°
- > ingressi da 3/4"

**PARTI ESTERNE - CROMATO**  
 01-7708/E

**PARTI ESTERNE - ALTRE FINITURE**  
 XX-7708/E **x M\***

**PARTE INCASSO**  
 054027 info pag. 40

**PREZZO TOTALE**



**7908/L/E + 054027 DX o 054028 SX | B-DUE**

**RUBINETTO D'ARRESTO 3/4"**

*BUILT-IN STOP COCK 3/4"*

- > vitone ceramico 90°
- > ingressi da 3/4"

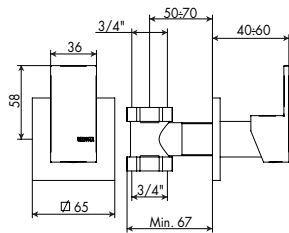

<b>PARTI ESTERNE - CROMATO</b>
01-7908/L/E
<b>PARTE INCASSO</b>
054027 o 054028 info pag. 40/41
<b>PREZZO TOTALE</b>

<b>PARTI ESTERNE - ALTRE FINITURE</b>
XX-7908/L/E <b>x M*</b>



VITONE CERAMICO  
CERAMIC VALVE

055001 DX



VITONE CERAMICO  
CERAMIC VALVE

055002 SX

**7740/E + 884053 | B-UNO**

**PASSO RAPIDO 3/4"**

*BUILT-IN RAPID FLOW COCK 3/4"*

- > vitone tradizionale
- > abbinare a saracinesca
- > ingressi da 3/4"

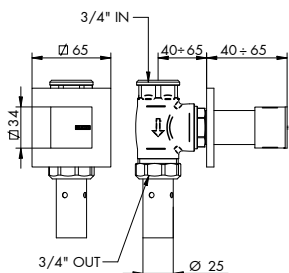

<b>PARTI ESTERNE - CROMATO</b>
01-7740/E
<b>PARTE INCASSO</b>
884053 info pag. 43
<b>PREZZO TOTALE</b>

<b>PARTI ESTERNE - ALTRE FINITURE</b>
XX-7740/E <b>x M*</b>



VITONE  
TRADIZIONALE  
TRADITIONAL VALVE

884021

**7940/L/E + 654099 | B-DUE**

**PASSO RAPIDO 3/4"**

*BUILT-IN RAPID FLOW COCK 3/4"*

- > vitone tradizionale
- > abbinare a saracinesca
- > ingressi da 3/4"

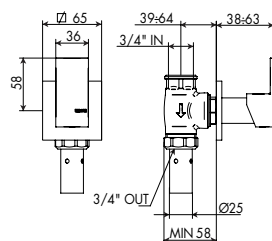

<b>PARTI ESTERNE - CROMATO</b>
01-7940/L/E
<b>PARTE INCASSO</b>
654099 info pag. 42
<b>PREZZO TOTALE</b>

<b>PARTI ESTERNE - ALTRE FINITURE</b>
XX-7940/L/E <b>x M*</b>



VITONE  
TRADIZIONALE  
TRADITIONAL VALVE

654067

**7740/E + 884054 | B-UNO**

**PASSO RAPIDO 1"**

*BUILT-IN RAPID FLOW COCK 1"*

- > vitone tradizionale
- > abbinare a saracinesca
- > ingressi da 1"

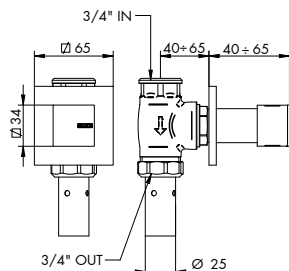

<b>PARTI ESTERNE - CROMATO</b>
01-7740/E
<b>PARTE INCASSO</b>
884054 info pag. 43
<b>PREZZO TOTALE</b>

<b>PARTI ESTERNE - ALTRE FINITURE</b>
XX-7740/E <b>x M*</b>



VITONE  
TRADIZIONALE  
TRADITIONAL VALVE

884021

7940/L/E + 654100 | B-DUE

PASSO RAPIDO 1"  
BUILT-IN RAPID FLOW COCK 1"

- > vitone tradizionale
- > abbinare a saracinesca
- > ingressi da 1"

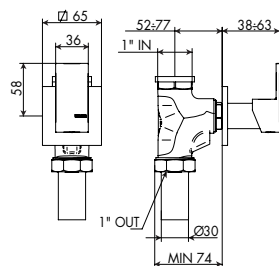

PARTI ESTERNE - CROMATO	
01-7940/L/E	
PARTE INCASSO	
654100	info pag. 43
PREZZO TOTALE	

PARTI ESTERNE - ALTRE FINITURE	
XX-7940/L/E	x M*
PREZZO TOTALE	



7732/2/E + 035212 | B-UNO

SARACINESCA  
GATE VALVE

- > attacchi da 3/4"

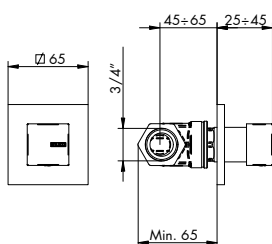

PARTI ESTERNE - CROMATO	
01-7732/2/E	
PARTE INCASSO	
035212	info pag. 43
PREZZO TOTALE	

PARTI ESTERNE - ALTRE FINITURE	
XX-7732/2/E	x M*
PREZZO TOTALE	

7932/2L/E + 035212 | B-DUE

SARACINESCA  
GATE VALVE

- > attacchi da 3/4"

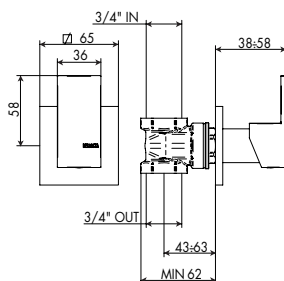

PARTI ESTERNE - CROMATO	
01-7932/2L/E	
PARTE INCASSO	
035212	info pag. 43
PREZZO TOTALE	

PARTI ESTERNE - ALTRE FINITURE	
XX-7932/2L/E	x M*
PREZZO TOTALE	







**AERATORI C/CHIAVE  
AERATORS AND KEY**

795004 senza finitura

795005 senza finitura



**CARTUCCE  
CARTRIDGES**

025002 senza finitura

735005 senza finitura



**DEVIATORI  
DIVERTERS**

105029 senza finitura

01-654020 cromato

XX-654020 altre finiture

724030 senza finitura



**CARTUCCE TERMOSTATICHE  
THERMOSTATIC CARTRIDGES**

775007 senza finitura



**CARTUCCE DEVIATRICI  
DIVERTER CARTRIDGES**

035344 senza finitura

035345 senza finitura

035346 senza finitura

635010 senza finitura

635011 senza finitura

635012 senza finitura

755058 senza finitura



**VITONI CERAMICI  
CERAMIC VALVES**

055001 senza finitura

055002 senza finitura

055134 senza finitura



**VITONI TRADIZIONALI  
TRADITIONAL VALVES**

654067 senza finitura

884021 senza finitura



B-UNO  
B-DUE

ELENCO COMPLETO DISPONIBILE ON LINE: [WWW.BELLOSTARUBINETTERIE.COM/ONLINE/RICAMBI.PDF](http://WWW.BELLOSTARUBINETTERIE.COM/ONLINE/RICAMBI.PDF)  
LISTED COMPLETED AVAILABLE ON LINE: [WWW.BELLOSTARUBINETTERIE.COM/ONLINE/RICAMBI.PDF](http://WWW.BELLOSTARUBINETTERIE.COM/ONLINE/RICAMBI.PDF)

