



INDICE | INDEX

| | | |
|-------------------------------------|------|---------|
| DOCCIA INCASSO TERMOSTATICO 3/4" | pag. | 349/352 |
| DEVIATORI INCASSO 3/4" | pag. | 353 |
| RUBINETTI D'ARRESTO | pag. | 354 |
| RUBINETTI INCASSO CON FILTRO | pag. | 355 |

REVIVRE collection

| | | |
|-------------------------|------|-----|
| INFO TECNICHE | pag. | 347 |
| TABELLA PREZZI FINITURE | pag. | 348 |

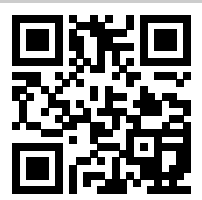

CONSULTA LISTINO ON LINE
CHECK ON LINE PRICE LIST

www.bellostarubinetterie.com/online/18_comandi_quadro.pdf

COMANDI QUADRO HP

EQB DESIGN

NOTA VALIDA PER TUTTI I MISCELATORI INCASSO ALTA PORTATA

Campo di funzionamento da 0,5 bar a 5 bar (per pressioni superiori inserire limitatori di portata). Portata a 3 bar, singola uscita circa 40 l/min.

NOTE FOR ALL BUILT-IN THERMOSTATIC MIXER HIGH RATE

From 0,5 bar to 5 bar (for more pressure used flow-limit). From 3 bar, at one way 40 l/min

COMANDI TERMOSTATICI AD ALTA PORTATA

Tutti i comandi termostatici ad alta portata possono essere installati in verticale (con entrate dell'acqua calda e fredda rivolte verso il basso) o in orizzontale (con entrate dell'acqua calda e fredda rivolte verso il lato destro).

Blocco di sicurezza a 38 °C

Temperatura minima di esercizio: 3°C FREDDA (consigliata 15°C)

Temperatura massima di esercizio: 80°C CALDA (consigliata 65°C) Differenziale termico consigliato: 50°C

Pressione minima di esercizio: 0.5 bar

Pressione massima di esercizio: 5 bar (per pressioni superiori si raccomanda di installare un limitatore di pressione)

Pressione d'esercizio consigliata: 3 bar

Sistema di sicurezza con blocco dell'erogazione, in caso di mancanza di una delle due acque

Dotati di filtri in acciaio inox per il trattenimento delle impurità

CARATTERISTICHE DEI TERMOSTATICI ALTA PORTATA DA 1 A 4 USCITE CON PIASTRE UNITE E SINGOLE VINCOLATE

1) Tutte le uscite sono indipendenti (si possono aprire in contemporanea – in questo caso, logicamente, la portata si ripartisce su tutte le vie aperte).

2) I rubinetti singoli presentano l'erogazione dell'acqua verso destra (o verso l'alto se installati in orizzontale).

3) I termostatici da 1 a 4 uscite presentano tutte le vie di erogazione dell'acqua verso destra (o tutte verso l'alto se installati in orizzontale).

4) A 3 bar, le portate per una singola uscita sono di 40 l/min circa.

FUNZIONAMENTO:

Sia con scaldabagni a gas che elettrici ad accumulo

Impianti centralizzati

Caldaie murali e da terra ad accumulo

ATTENZIONE:

Si consiglia, di contattare il proprio termoidraulico di fiducia per una corretta e funzionale installazione del miscelatore termostatico, sia con i dispositivi di riscaldamento sopraelencati, che con altre tipologie.

HIGH RATE THERMOSTATIC MIXER

All high rate thermostatic mixer can be installed in vertical (with hot and cold water inlets pointing down) or horizontally (with hot and cold water directed toward the right side).

Safety block at 38° C

Minimum working temperature 3°C COLD WATER (suggested 15°C)

Maximum working temperature 80°C HOT WATER (suggested 65°C)

Suggested temperature differential: 50°C

Minimum pressure of working: 0.5 bar

Maximum operating pressure: 5 bar (For higher hydraulic pressures we recommend to install a pressure reducer)

Pressure of working advised: 3 bar

Safety system with water supply block in case either hot or cold water is missing

Supplied with steel filter to keep the impurity out

FEATURES OF HIGH CAPACITY THERMOSTATIC MIXERS FROM 1 TILL 4 EXITS WITH OPTION OF ONE OR SEPARATE RESTRICTED WALL CONTROLS

1) All the outflows are unconnected (they can be open at the same time – obviously in this case the water-flow capacity divides onto all the open ways).

2) The single taps have the water-flow towards the right hand-side (or towards the top if they are sep up in the horizontal position).

3) The thermostatic mixers with one/four outflows have all the water-flow gateways towards the right hand-side (or all the gateways towards the top if they are set up in the horizontal position).

4) To three bars, the single gateway water-flow capacities are about 40 l/min.

INSTRUCTIONS:

It works both with electrical and gas water heater

Central heating systems

Wall and floor boiler

ATTENTION:

It is strongly recommended that the product is only installed by a fully qualified plumber who is aware of the installation and the pressure requirements of the system (both for the heating systems above mentioned and others).

SCHEMA FUNZIONAMENTO MISCELATORI TERMOSTATICI 2/3/4 USCITE

Leva in posizione ore 12 = deviatore chiuso. Ruotando verso destra o sinistra si attivano le diverse uscite. Partendo dalla posizione di STOP, durante la rotazione la portata dell'acqua si incrementa verso la posizione successiva. Tra 2 uscite adiacenti durante la rotazione diminuisce la portata dell'uscita iniziale ed incrementa quella della successiva. In posizione intermedia sono entrambe attive a pari portata.

SCHEME OPERATING THERMOSTATIC MIXER 2/3/4 OUT

Lever to the 12 o'clock position = switch closed. Turning left or right. They activate different outputs. Starting from the STOP position, while rotation of the water flow rate between two adjacent outputs is increased towards the next position. Between two adjacent outputs during the rotation decreases the initial output flow and increases that of the next. In position intermediate are both active at the same flow rate.



SCHEMA FUNZIONAMENTO DEVIATORI 2/3/5 USCITE 3/4"

DEVIATORI 2/3 USCITE: Leva in posizione ore 12 = deviatore chiuso. Ruotando verso destra o sinistra si attivano le diverse uscite. Partendo dalla posizione di STOP, durante la rotazione la portata dell'acqua si incrementa verso la posizione successiva. Tra 2 uscite adiacenti durante la rotazione diminuisce la portata dell'uscita iniziale ed incrementa quella della successiva. In posizione intermedia sono entrambe attive a pari portata.

DEVIATORI 5 USCITE: Questi deviatori non hanno funzione di chiusura. Ruotando verso destra o sinistra si attivano le uscite. Tra 2 uscite adiacenti durante la rotazione diminuisce la portata dell'uscita iniziale ed incrementa quella della successiva. In posizione intermedia sono entrambe attive a pari portata.

SCHEME OPERATION SWITCHES FLUSH OUTPUT 2/3/5 3/4"

SWITCHES FLUSH OUTPUT 2/3: Lever to the 12 o'clock position = switch closed. Turning left or right. They activate different outputs. Starting from the STOP position, while rotation of the water flow rate between two adjacent outputs is increased towards the next position. Between two adjacent outputs during the rotation decreases the initial output flow and increases that of the next. In position intermediate are both active at the same flow rate.

SWITCHES FLUSH OUTPUT 5: These diverters have not closing function. By turning to the right or left activates the outputs. Between two adjacent outputs during the rotation decreases the initial output flow and increases that of the next. In position intermediate are both active at the same flow rate.

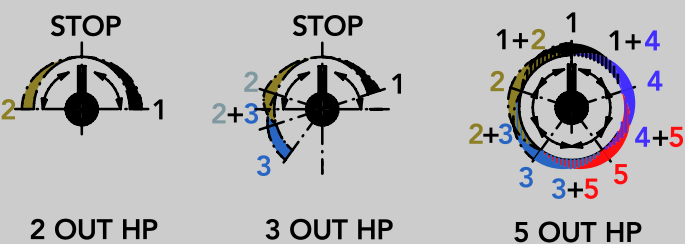

PROGETTO SU MISURA: RICHIESTE SPECIALI

I tecnici di Bellosta Rubinetterie sono, inoltre, a disposizione di architetti e designers, per offrire un servizio esclusivo: personalizzazioni di elementi in funzione di specifiche richieste estetiche o problematiche legate a vincoli progettuali, verifica della fattibilità attraverso opportuni studi CAD e sviluppo del disegno tecnico del prodotto speciale richiesto.

Per informazioni e richieste PROGETTI SU MISURA:

ufficiotecnico@bellostarubinetterie.com



progetto
sumisura

PROGETTO SU MISURA: SPECIAL REQUESTS

Engineers Bellosta Rubinetterie are also available to architects and designers, to offer an exclusive service: customizations of items according to specific aesthetic requirements or issues related to design constraints, verification of the feasibility studies and development through appropriate CAD technical design the required special product. For information and requests "SU MISURA" PROJECTS: ufficiotecnico@bellostarubinetterie.com



COMANDI
QUADRO
HP

PREZZO FINITURE

Calcola il prezzo di listino (IVA esclusa) delle finiture diverse dal cromato, consultando la seguente tabella.

Moltiplicare il **PREZZO LISTINO** per il **COEFFICIENTE MOLTIPLICATORE** della finitura scelta, arrotondando per difetto il prezzo ottenuto (eliminare i centesimi).
ESEMPIO per ordinare art. 0912/3H/E in finitura dorato: codice 04-0912/3H/E

PRICE FINISHES

Include the list price (excluding VAT) of different finishes from chrome, consulting the following table. **Multiply the PRICE LIST MULTIPLIER COEFFICIENT** of the chosen finish, reducing the price obtained by deleting the centesim.

EXAMPLE to order art. 0912/3H/E gold finish: code 04-0912/3H/E

COMPOSIZIONE CODICE PER ORDINARE ARTICOLO IN FINITURA

XX - **0912/3H/E**

CODICE FINITURA
FINISH CODE

CODICE ARTICOLO
ITEM NUMBER

MOLTIPLICATORI FINITURE DI SERIE
STANDARD FINISHES MULTIPLIERS

| COD. CODE | DESCRIZIONE FINITURA FINISH DESCRIPTION | COMANDI QUADRO | RICAMBI | DOCCIA COMPL. |
|-----------|---|----------------|---------|-----------------|
| 01- | cromato/chrome | | | PREZZO LISTINO° |

MOLTIPLICATORI FINITURE A RICHIESTA
ON REQUEST FINISHES MULTIPLIERS

| COD. CODE | DESCRIZIONE FINITURA FINISH DESCRIPTION | COMANDI QUADRO | RICAMBI | DOCCIA COMPL. |
|-----------|---|----------------|---------|---------------|
| 02- | cromo/oro/chrome/gold | | | |
| 03- | oro/argento/gold/silver | | | |
| 04- | dorato/gold | | | |
| 05- | bronzo satinato/satin bronze | | | |
| 06- | rame vecchio/old copper | | | |
| 07- | vecchio argento/old silver | | | |
| 08- | canna di fucile/gun barrel | | | |
| 10- | verderame/verdigris | | | |
| 11- | nero antracite/anthracite black | | | |
| 12- | ottone lucido/polished brass | | | |
| 13- | ottone naturale/natural brass | | | |
| 14- | bianco lucido/glossy white | | | |
| 19- | nero lucido/glossy black | | | |
| 28- | nickel satinato/satin nickel | | | |
| 30- | nickel lucido/polished nickel | | | |
| 33- | cromo satinato/satin chrome | | | |
| 34- | cromo spazzolato/brushing chrome | | | |
| 35- | nickel spazzolato/brushing nickel | | | |
| 56- | avorio/ivory | | | |
| 57- | azzurro/light blue | | | |
| 58- | verdino/light green | | | |

MOLTIPLICATORI FINITURE A RICHIESTA
ON REQUEST FINISHES MULTIPLIERS

| COD. CODE | DESCRIZIONE FINITURA FINISH DESCRIPTION | COMANDI QUADRO | RICAMBI | DOCCIA COMPL. |
|-----------|---|----------------|---------|---------------|
| 59- | marrone/brown | | | |
| 60- | arancio/orange | | | |
| 61- | rosso/red | | | |
| 66- | bianco opaco/mat white | | | |
| 67- | nero opaco/matt black | | | |
| 68- | rame opaco/matt copper | | | |
| 69- | argento opaco/matt silver | | | |
| 71- | oro opaco/matt gold | | | |
| 72- | bronzo opaco/matt bronze | | | |
| 75- | dorato spazzolato/brushing gold | | | |
| 87- | oro rosa/pink gold | | | |
| 88- | ottone sisal/sisal brass | | | |
| 89- | industrial | | | |
| 92- | pomice opaco/matt pumice | | | |
| 93- | arenaria opaco/matt sandstone | | | |
| 94- | tuscany spazzolato/brushing tuscany | | | |
| 95- | rame acidato/etched copper | | | |
| 96- | cemento opaco/matt cement | | | |
| A1- | brina opaco/matt frost | | | |
| A2- | tuscany cerato/oilskin tuscany | | | |
| A3- | ottone acidato/etched brass | | | |
| A4- | basalto opaco/matt basalt | | | |
| B2- | black gun metal PVD | | | |
| B3- | nickel PVD | | | |
| B4- | matt gold PVD | | | |

°PREZZO DI LISTINO PRICE LIST
RICAMBI SPARE PARTS

* N.R. = NON REALIZZABILE NOT MADE
ACCESSORI ACCESSORIES

RICH. = PREZZO A RICHIESTA ON REQUEST PRICE
DOCCIA COMPLEMENTI SHOWER COMPLEMENTS

NOTE:

Per art. 8816/E utilizzare moltiplicatori DOCCIA COMPLEMENTI.

NOTE:

For art. 8816/E use multipliers of DOCCIA COMPLEMENTI collection.

ATTENZIONE! 13-OTTONE NATURALE e 88-OTTONE SISAL: finiture non protette che antichizzano naturalmente ossidando a contatto con l'umidità atmosferica.
WARNING! 13-NATURAL BRASS and 88-SISAL BRASS: unprotected finishes that naturally oxidise in contact with atmospheric humidity.

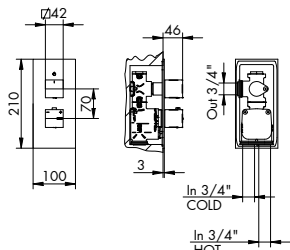

0912/H/P/E + 774035

MISCELATORE TERMOSTATICO INCASSO 1 USCITA HP
THERMOSTATIC BUILT-IN MIXER 1 OUT HIGH FLOW RATE

- > cartuccia termostatica
- > vitone ceramico 90°
- > apertura con rotazione antioraria
- > interasse 70 mm
- > ingressi inferiori da 3/4"
- > incasso con B-Box
- > posizionabile orizzontalmente
- > uscite laterali destra da 3/4"
- > incasso regolabile min 76



8816/E + 775025 p. 182

PARTI ESTERNE - CROMATO

01-0912/H/P/E €

PARTI ESTERNE - ALTRE FINITURE

XX-0912/H/P/E € x M*

PARTE INCASSO

774035 info pag. 320 €

PREZZO TOTALE €

MANIGLIA
TEMPERATURA
TEMPERATURE HANDLE

774037

MANIGLIA APERTURA
OPENING HANDLE

774043

PIASTRA
PLATE

774041

VITONE CERAMICO
CERAMIC VALVE

055134

CART. TERMOSTATICA
THERMOSTATIC
CARTRIDGE

775007

0912/2H/P/E + 774036

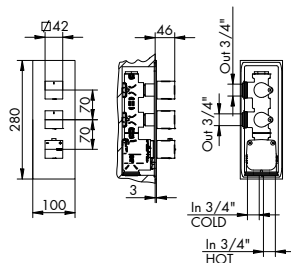
MISCELATORE TERMOSTATICO INCASSO 2 USCITE HP
THERMOSTATIC BUILT-IN MIXER 2 OUT HIGH FLOW RATE

- > cartuccia termostatica
- > vitone ceramico 90°
- > 2 aperture con rotazione antioraria
- > interasse 70 mm
- > ingressi inferiori da 3/4"
- > incasso con B-Box
- > posizionabile orizzontalmente
- > uscite laterali destra da 3/4"
- > incasso regolabile min 76



8816/E + 775025 p. 182

PARTI ESTERNE - CROMATO

01-0912/2H/P/E €

PARTI ESTERNE - ALTRE FINITURE

XX-0912/2H/P/E € x M*

PARTE INCASSO

774036 info pag. 320 €

PREZZO TOTALE €

MANIGLIA
TEMPERATURA
TEMPERATURE HANDLE

774037

MANIGLIA APERTURA
OPENING HANDLE
(1 PZ)

774043

PIASTRA
PLATE

774040

VITONE CERAMICO
CERAMIC VALVE
(1 PZ)

055134

CART. TERMOSTATICA
THERMOSTATIC
CARTRIDGE

775007

0912/3H/P/E + 774033

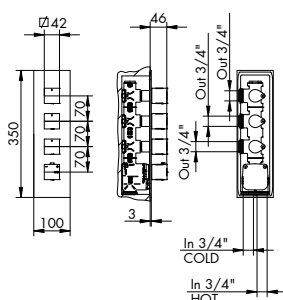
MISCELATORE TERMOSTATICO INCASSO 3 USCITE HP
THERMOSTATIC BUILT-IN MIXER 3 OUT HIGH FLOW RATE

- > cartuccia termostatica
- > vitone ceramico 90°
- > 3 aperture con rotazione antioraria
- > interasse 70 mm
- > ingressi inferiori da 3/4"
- > incasso con B-Box
- > posizionabile orizzontalmente
- > uscite laterali destra da 3/4"
- > incasso regolabile min 76



8816/E + 775025 p. 182

PARTI ESTERNE - CROMATO

01-0912/3H/P/E €

PARTI ESTERNE - ALTRE FINITURE

XX-0912/3H/P/E € x M*

PARTE INCASSO

774033 info pag. 320 €

PREZZO TOTALE €

MANIGLIA
TEMPERATURA
TEMPERATURE HANDLE

774037

MANIGLIA APERTURA
OPENING HANDLE
(1 PZ)

774043

PIASTRA
PLATE

774039

VITONE CERAMICO
CERAMIC VALVE
(1 PZ)

055134

CART. TERMOSTATICA
THERMOSTATIC
CARTRIDGE

775007

0912/4H/P/E + 774034

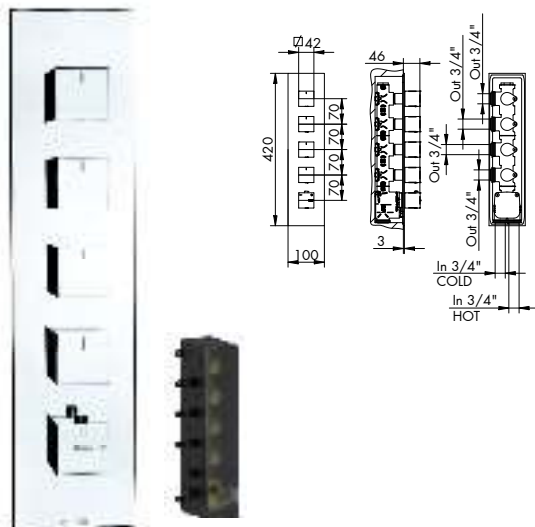

MISCELATORE TERMOSTATICO INCASSO 4 USCITE HP
THERMOSTATIC BUILT-IN MIXER 4 OUT HIGH FLOW RATE

- > cartuccia termostatica
- > vitone ceramico 90°
- > 4 aperture con rotazione antioraria
- > interasse 70 mm
- > ingressi inferiori da 3/4"
- > incasso con B-Box
- > posizionabile orizzontalmente
- > uscite laterali destra da 3/4"
- > incasso regolabile min 76

PILETTA DOCCIA SHOWER WASTE
8816/E + 775025 p. 182

PARTI ESTERNE - CROMATO

01-0912/4H/P/E €

PARTE INCASSO

774034 info pag. 320 €

PREZZO TOTALE €

PARTI ESTERNE - ALTRE FINITURE

XX-0912/4H/P/E € x M*



0912/H/E + 884036

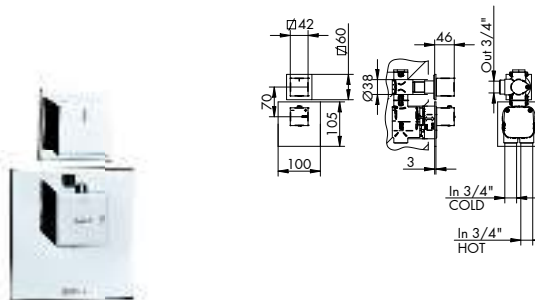

MISCELATORE TERMOSTATICO INCASSO 1 USCITA HP
THERMOSTATIC BUILT-IN MIXER 1 OUT HIGH FLOW RATE

- > cartuccia termostatica
- > vitone ceramico 90°
- > apertura con rotazione antioraria
- > interasse 70 mm
- > ingressi inferiori da 3/4"
- > posizionabile orizzontalmente
- > uscite laterali destra da 3/4"
- > incasso regolabile min 76

PILETTA DOCCIA SHOWER WASTE
8816/E + 775025 p. 182

PARTI ESTERNE - CROMATO

01-0912/H/E €

PARTE INCASSO

884036 info pag. 321 €

PREZZO TOTALE €

PARTI ESTERNE - ALTRE FINITURE

XX-0912/H/E € x M*



0912/2H/E + 884037

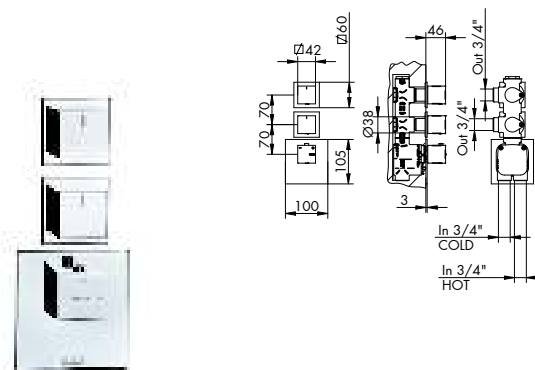

MISCELATORE TERMOSTATICO INCASSO 2 USCITE HP
THERMOSTATIC BUILT-IN MIXER 2 OUT HIGH FLOW RATE

- > cartuccia termostatica
- > vitone ceramico 90°
- > 2 aperture con rotazione antioraria
- > interasse 70 mm
- > ingressi inferiori da 3/4"
- > incasso senza B-Box
- > posizionabile orizzontalmente
- > uscite laterali destra da 3/4"
- > incasso regolabile min 76

PILETTA DOCCIA SHOWER WASTE
8816/E + 775025 p. 182

PARTI ESTERNE - CROMATO

01-0912/2H/E €

PARTE INCASSO

884037 info pag. 321 €

PREZZO TOTALE €

PARTI ESTERNE - ALTRE FINITURE

XX-0912/2H/E € x M*



COMANDI QUADRO HP

094025 | 094022 | 094023 | 094024**KIT PROLUNGA MIX INCASSO TERMOSTATICO**
BUILT-IN THERMOSTATIC MIXER EXTENSION KIT

- > lunghezza 3 cm
- > 094025 per art. 0912/H/P/E, 0912/H/E, 0912/SH/E
- > 094022 per art. 0912/2H/P/E, 0912/2H/E
- > 094023 per art. 0912/3H/P/E, 0912/3H/E
- > 094024 per art. 0912/4H/P/E, 0912/4H/E

**GREZZO**

| | | |
|---------------|-------|---|
| 094025 | 1 out | € |
| 094022 | 2 out | € |
| 094023 | 3 out | € |
| 094024 | 4 out | € |



7703/2H/E + 774047

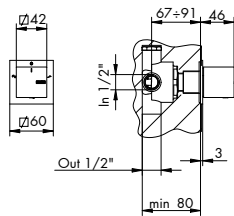

DEVIATORE INCASSO 2 USCITE HP

BUILT-IN DIVERTER 2 OUT HIGH FLOW RATE

- > deviatore a dischi ceramici 2 uscite con chiusura
- > attacchi da 1/2"
- > alta portata
- > abbinare a miscelatore o rubinetti d'arresto

| | |
|--------------------------------|-----------------|
| PARTI ESTERNE - CROMATO | |
| 01-7703/2H/E | € |
| PARTE INCASSO | |
| 774047 | info pag. 323 € |
| PREZZO TOTALE | € |

| | |
|---------------------------------------|--------|
| PARTI ESTERNE - ALTRE FINITURE | |
| XX-7703/2H/E | € x M* |



7703/3H/E + 774048

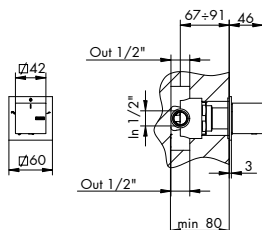

DEVIATORE INCASSO 3 USCITE HP

BUILT-IN DIVERTER 3 OUT HIGH FLOW RATE

- > deviatore a dischi ceramici 3 uscite con chiusura
- > attacchi da 1/2"
- > alta portata
- > abbinare a miscelatore o rubinetti d'arresto

| | |
|--------------------------------|-----------------|
| PARTI ESTERNE - CROMATO | |
| 01-7703/3H/E | € |
| PARTE INCASSO | |
| 774048 | info pag. 323 € |
| PREZZO TOTALE | € |

| | |
|---------------------------------------|--------|
| PARTI ESTERNE - ALTRE FINITURE | |
| XX-7703/3H/E | € x M* |



7703/5H/E + 774049

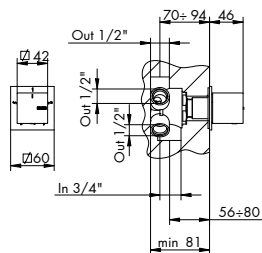

DEVIATORE INCASSO 5 USCITE HP

BUILT-IN DIVERTER 5 OUT HIGH FLOW RATE

- > deviatore a dischi ceramici 5 uscite senza chiusura
- > 1 ingresso inferiore da 3/4"
- > uscite equivalenti da 1/2" a stella
- > abbinare a miscelatore o rubinetti d'arresto

| | |
|--------------------------------|-----------------|
| PARTI ESTERNE - CROMATO | |
| 01-7703/5H/E | € |
| PARTE INCASSO | |
| 774049 | info pag. 323 € |
| PREZZO TOTALE | € |

| | |
|---------------------------------------|--------|
| PARTI ESTERNE - ALTRE FINITURE | |
| XX-7703/5H/E | € x M* |

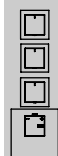

COMANDI QUADRO HP

0908/H/E + 774032

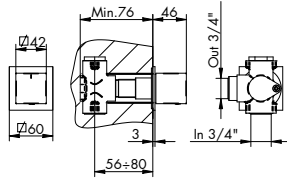

RUBINETTO D'ARRESTO HP
BUILT-IN STOP COCK HIGH FLOW RATE

- > vitone ceramico 90°
- > maniglia quadra
- > attacchi da 3/4"

PARTI ESTERNE - CROMATO

01-0908/H/E €

PARTE INCASSO

774032 info pag. 324 €

PREZZO TOTALE €

PARTI ESTERNE - ALTRE FINITURE

XX-0908/H/E € **x M***



MANIGLIA
HANDLE
774043



ROSONE
ROSE WINDOW
774050



VITONE CERAMICO
CERAMIC VALVE
055134

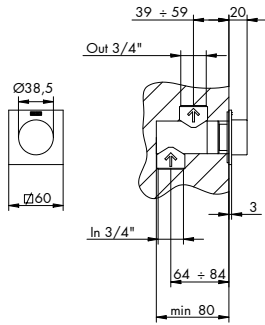

0920/2/E + 094016

RUBINETTO INCASSO CON FILTRO
BUILT-IN STOP COCK WITH FILTER

- > attacchi da 3/4"
- > filtro interno per raccolta macro impurità
- > rosone quadro

PARTI ESTERNE - CROMATO

01-0920/2/E €

PARTE INCASSO

094016 info pag. 325 €

PREZZO TOTALE €**PARTI ESTERNE - ALTRE FINITURE**

XX-0920/2/E € x M*

