



GOLD collection

INFO TECNICHE pag. 159

TABELLA PREZZI FINITURE pag. 160



CONSULTA LISTINO ON LINE
CHECK ON LINE PRICE LIST

www.bellostarubinetterie.com/online/09_electa.pdf

INDICE | INDEX

LAVABO	pag. 161/164
BIDET	pag. 164
DOCCIA INCASSO	pag. 165
DEVIATORI INCASSO	pag. 165/166
DOCCIA INCASSO TERMOSTATICO	pag. 166/167
DOCCIA COMPLEMENTI	pag. 168
SOFFIONI/BRACCI	pag. 168
COMPONI SET DOCCIA	pag. 168
VASCA	pag. 168/169
BAGNO COMPLEMENTI	pag. 169/170
RICAMBI	pag. 171

FORATURA DEI PIANI SANITARI

I miscelatori lavabo/bidet monoforo prevedono un foro di diametro 35 mm nel piano sanitario. Le batterie lavabo 3 fori sono dotate di vitone ceramico destro con apertura a 1/4 di giro (90°); l'interasse consigliato è di 110 mm e foratura come da schema sottostante.

DRILLING PLANS HEALTH

The sink / hole bidet mixers provide a hole diameter of 35 mm in the health plan. The sink batteries 3 holes are equipped with ceramic cartridge Right-open 1/4 turn (90°); the recommended distance is 110 mm, drilling as per the diagram below.

MONOFORO >>

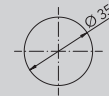

3 FORI >>

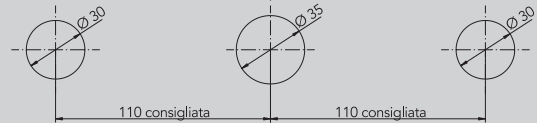

INSTALLAZIONE LAVABI A MURO

Distanza verticale consigliata tra l'uscita dell'acqua ed il bordo superiore del lavabo 8÷10 cm.

WALL-MOUNTED WASHBASIN INSTALLATION

Recommended vertical distance between the water outlet and the upper edge of the sink 8÷10 cm.

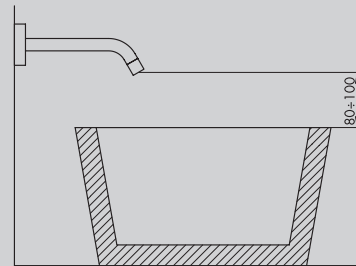

SCHEMA FUNZIONAMENTO DEVIATORI INCASSO 2/3/4 USCITE

Questi deviatori non hanno funzione di chiusura. Ruotando verso destra o sinistra si attivano le uscite. Tra 2 uscite adiacenti durante la rotazione diminuisce la portata dell'uscita iniziale ed incrementa quella della successiva. In posizione intermedia sono entrambe attive a pari portata.

SCHEME OPERATION SWITCHES FLUSH OUTPUT 2/3/4

These diverters have not closing function. By turning to the right or left activates the outputs. Between two adjacent outputs during the rotation decreases the initial output flow and increases that of the next. In position intermediate are both active at the same flow rate.

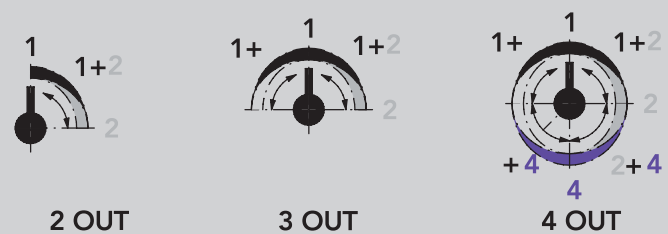

SCHEMA FUNZIONAMENTO MISCELATORI TERMOSTATICI 2/3/4 USCITE

Lever in posizione ore 12 = deviatore chiuso. Ruotando verso destra o sinistra si attivano le diverse uscite. Partendo dalla posizione di STOP, durante la rotazione la portata dell'acqua si incrementa verso la posizione successiva. Tra 2 uscite adiacenti durante la rotazione diminuisce la portata dell'uscita iniziale ed incrementa quella della successiva. In posizione intermedia sono entrambe attive a pari portata.

SCHEME OPERATING THERMOSTATIC MIXER 2/3/4 OUT

Lever to the 12 o'clock position = switch closed. Turning left or right. They activate different outputs. Starting from the STOP position, while rotation of the water flow rate between two adjacent outputs is increased towards the next position. Between two adjacent outputs during the rotation decreases the initial output flow and increases that of the next. In position intermediate are both active at the same flow rate.



CONSIGLIO TECNICO

Tutti i miscelatori della collezione ELECTA vengono collaudati nel loro funzionamento al momento dell'assemblaggio. Per garantire la durata delle cartucce nel tempo, si consiglia di spurgare bene l'impianto idraulico prima del montaggio (per rimuovere eventuali detriti) e di installare rubinetti sottolavabo con filtro (art. 020).

N.B.: Qualora il piano lavabo avesse uno spessore superiore a 4 cm specificare la misura al momento dell'ordine.

TECHNICAL ADVICE

All mixers of the ELECTA collection are perfectly tested. To guarantee the perfect functionality of the cartridge for a long time, we advise to clean the sanitary plant before installing the mixer. Moreover we advise to install angle valve with filter (art. 020).

Attention: If the lavatory top is more than cm 4 hick, please point it out when placing the order.



ELECTA

RISPARMIO IDRICO

Per il risparmio idrico, tutte le bocche lavabo e bidet hanno aeratori con portata del flusso a 5 lt/min, sostituibili con aeratori di portata superiore qualora la bocca di erogazione venga utilizzata per il riempimento vasca.

SAVING WATER

For the saving water, all the basin and bidet spout have aerator with flow rate at 5lt/min, interchangeable with more flow rate aerator, in the case of using spout for fill up the bath.

SCHEMA DI FUNZIONAMENTO MANIGLIA MISCELATORE INCASSO

SCHEME ABOUT WORKING WAY HANDLE FOR BUILT-IN MIXER

apertura
opening



acqua calda
hot water



acqua fredda
cold water

PROGETTO SU MISURA: RICHIESTE SPECIALI

I tecnici di Bellosta Rubinetterie sono, inoltre, a disposizione di architetti e designers, per offrire un servizio esclusivo: personalizzazioni di elementi in funzione di specifiche richieste estetiche o problematiche legate a vincoli progettuali, verifica della fattibilità attraverso opportuni studi CAD e sviluppo del disegno tecnico del prodotto speciale richiesto.

Per informazioni e richieste PROGETTI SU MISURA:
ufficiotecnico@bellostarubinetterie.com

PROGETTO SU MISURA: SPECIAL REQUESTS

Engineers Bellosta Rubinetterie are also available to architects and designers, to offer an exclusive service: customizations of items according to specific aesthetic requirements or issues related to design constraints, verification of the feasibility studies and development through appropriate CAD technical design the required special product. For information and requests "SU MISURA" PROJECTS:

ufficiotecnico@bellostarubinetterie.com



progetto
"sumisura"

PREZZO FINITURE

Calcola il prezzo di listino (IVA esclusa) delle finiture diverse dal cromato, consultando la seguente tabella.

Moltiplicare il **PREZZO LISTINO** per il **COEFFICIENTE MOLTIPLICATORE** della finitura scelta, arrotondando per difetto il prezzo ottenuto (eliminare i centesimi).
ESEMPIO per ordinare art. 5205/4/A/S in finitura dorato: codice 04-5205/4/A/S

PRICE FINISHES

Include the list price (excluding VAT) of different finishes from chrome, consulting the following table. **Multiply the PRICE LIST MULTIPLIER COEFFICIENT** of the chosen finish, reducing the price obtained by deleting the centesim.

EXAMPLE to order art. 5205/4/A/S gold finish: code 04-5205/4/A/S

COMPOSIZIONE CODICE PER ORDINARE ARTICOLO IN FINITURA

XX - **5205/4/A/S**

CODICE FINITURA
FINISH CODE

CODICE ARTICOLO
ITEM NUMBER

MOLTIPLICATORI FINITURE DI SERIE
STANDARD FINISHES MULTIPLIERS

COD. CODE	DESCRIZIONE FINITURA FINISH DESCRIPTION	ELECTA	RICAMBI	DOCCIA COMPL.
01-	cromato/chrome	PREZZO LISTINO°		

MOLTIPLICATORI FINITURE A RICHIESTA
ON REQUEST FINISHES MULTIPLIERS

COD. CODE	DESCRIZIONE FINITURA FINISH DESCRIPTION	ELECTA	RICAMBI	DOCCIA COMPL.
02-	cromo/oro/chrome/gold			
03-	oro/argento/gold/silver			
04-	dorato/gold			
05-	bronzo satinato/satin bronze			
06-	rame vecchio/old copper			
07-	vecchio argento/old silver			
08-	canna di fucile/gun barrel			
10-	verderame/verdigris			
11-	nero antracite/anthracite black			
12-	ottone lucido/polished brass			
13-	ottone naturale/natural brass			
14-	bianco lucido/glossy white			
19-	nero lucido/glossy black			
28-	nickel satinato/satin nickel			
30-	nickel lucido/polished nickel			
33-	cromo satinato/satin chrome			
34-	cromo spazzolato/brushing chrome			
35-	nickel spazzolato/brushing nickel			
56-	avorio/ivory			
57-	azzurro/light blue			
58-	verdino/light green			

MOLTIPLICATORI FINITURE A RICHIESTA
ON REQUEST FINISHES MULTIPLIERS

COD. CODE	DESCRIZIONE FINITURA FINISH DESCRIPTION	ELECTA	RICAMBI	DOCCIA COMPL.
59-	marrone/brown			
60-	arancio/orange			
61-	rosso/red			
66-	bianco opaco/mat white			
67-	nero opaco/matt black			
68-	rame opaco/matt copper			
69-	argento opaco/matt silver			
71-	oro opaco/matt gold			
72-	bronzo opaco/matt bronze			
75-	dorato spazzolato/brushing gold			
87-	oro rosa/pink gold			
88-	ottone sisal/sisal brass			
89-	industrial			
92-	pomice opaco/matt pumice			
93-	arenaria opaco/matt sandstone			
94-	tuscany spazzolato/brushing tuscany			
95-	rame acidato/etched copper			
96-	cemento opaco/matt cement			
A1-	brina opaco/matt frost			
A2-	tuscany cerato/oilskin tuscany			
A3-	ottone acidato/etched brass			
A4-	basalto opaco/matt basalt			
B2-	black gun metal PVD			
B3-	nickel PVD			
B4-	matt gold PVD			

°PREZZO DI LISTINO PRICE LIST
RICAMBI SPARE PARTS

* N.R. = NON REALIZZABILE NOT MADE
DOCCIA COMPLEMENTI SHOWER COMPLEMENTS

RICH. = PREZZO A RICHIESTA ON REQUEST PRICE

NOTE:

Flex art. 915003 realizzabile nelle seguenti finiture:
 01,03,04,05,06,07,12,13,19,28,30,33,34,35,66,67,68,69,71,72,75,B2,B3,B4.
 Per altre finiture ordinare art. 655016.

art. 044029, 044030, 044031: MOLTIPLICATORE SERIE BAMBU', PAG. 264.

NOTE:

Flex art. 915003 is available in the following finishes:
 01,03,04,05,06,07,12,13,19,28,30,33,34,35,66,67,68,69,71,72,75,B2,B3,B4.
 For other colors order the art. 655016.

art. 044029, 044030, 044031: MULTIPLIER BAMBU' COLLECTION, PAGE 264.

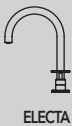

5205/4/A/S

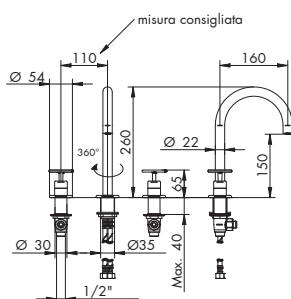
BATTERIA LAVABO TRE FORI BOCCA GIREVOLE
3 HOLE BASIN SWINGING SPOUT

- > vitone ceramico 90°
- > interasse bocca 160
- > bocca girevole 360°
- > limitatore di portata 5l/min 3bar
- > senza flessibili di alimentazione
- > senza scarico

TUBETTO C/CALOTTA
PIPE W/NUT

029 p. 893

SCARICO LAVABO
BASIN WASTE

0136/U p. 880

SIFONE
SIPHON

0133/L p. 879

CROMATO

01-5205/4/A/S

€

ALTRE FINITURE

XX-5205/4/A/S

€

x M*

AERATORE C/CHIAVE
AERATOR W/KEY

525001

VITONE CERAMICO (1PZ)
CERAMIC VALVE (1PC)

605007

5205/2/A/S

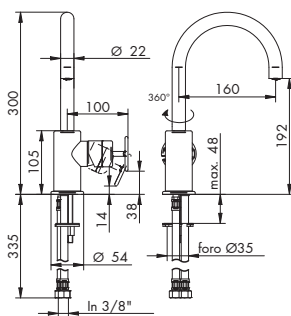
MISCELATORE LAVABO MONOFORO BOCCA GIREVOLE
BASIN MIXER SWINGING SPOUT

- > cartuccia tradizionale
- > interasse bocca 160
- > bocca girevole 360°
- > limitatore di portata 5l/min 3bar
- > flessibili di alimentazione
- > senza scarico
- > abbinare a rubinetto sottolavabo con filtro (art. 020)

SCARICO LAVABO
BASIN WASTE

0136/U p. 880

SIFONE
SIPHON

0133/L p. 879

CROMATO

01-5205/2/A/S

€

ALTRE FINITURE

XX-5205/2/A/S

€

x M*

AERATORE C/CHIAVE
AERATOR W/KEY

525001

CARTUCCIA
CARTRIDGE

025002

044029 | 044030 | 044031

PROLUNGHE MISCELATORE LAVABO
EXTENSIONS BASIN MIXER

- > diametro Ø 44,5 mm
- > altezza 50 mm, 100 mm, 150 mm

CROMATO

01-044029	50 mm	€
01-044030	100 mm	€
01-044031	150 mm	€

ALTRE FINITURE

XX-044029	50 mm	€	x M^
XX-044030	100 mm	€	x M^
XX-044031	150 mm	€	x M^

^ MOLTIPLICATORE SERIE BAMBU', PAG. 264
 ^ MULTIPLIER BAMBU' COLLECTION, PAGE 264

5205/6/E + 634024

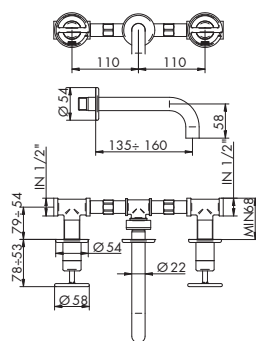
GRUPPO LAVABO A PARETE
WALL BASIN MOUNTED GROUP

- > vitone ceramico 90°
- > interasse bocca min 135 - max 160
- > limitatore di portata 5l/min 3bar
- > ingressi da 1/2"
- > senza scarico

SCARICO LAVABO
BASIN WASTE

0136/U p. 880

SIFONE
SIPHON

0133/L p. 879

PARTI ESTERNE - CROMATO

01-5205/6/E

€

PARTI ESTERNE - ALTRE FINITURE

XX-5205/6/E

€

x M*

PARTE INCASSO

634024 info pag. 27

€

PREZZO TOTALE

€

AERATORE C/CHIAVE
AERATOR W/KEY

525001

VITONE CERAMICO
(1PZ)
CERAMIC VALVE (1PC)

605007

5205/6/1/E + 634024

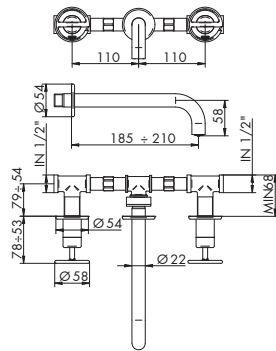
GRUPPO LAVABO A PARETE BOCCA PROLUNGATA
WALL BASIN MOUNTED GROUP EXTENDED SPOUT

- > vitone ceramico 90°
- > interasse bocca min 185 - max 210
- > limitatore di portata 5l/min 3bar
- > ingressi da 1/2"
- > senza scarico



PARTI ESTERNE - CROMATO

01-5205/6/1/E €

PARTE INCASSO

634024 info pag. 27 €

PREZZO TOTALE €

PARTI ESTERNE - ALTRE FINITURE

XX-5205/6/1/E € x M*

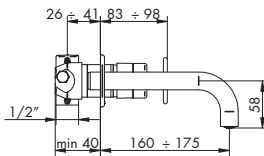
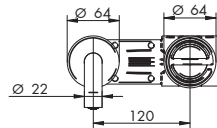

5205/3/A/E + 894001

MISCELATORE LAVABO DA PARETE
WALL BASIN MIXER

- > cartuccia tradizionale
- > interasse bocca min 160 - max 175
- > limitatore di portata 5l/min 3bar
- > ingressi da 1/2"
- > senza scarico
- > rosoni separati



PARTI ESTERNE - CROMATO

01-5205/3/A/E €

PARTE INCASSO

01-894001 info pag. 30 €

PREZZO TOTALE €

PARTI ESTERNE - ALTRE FINITURE

XX-5205/3/A/E € x M*



PER INSTALLAZIONI SU PARETI IN CARTONGESSO VERIFICARE LE DIMENSIONI DEL PANNELLO E ORDINARE LA NECESSARIA PROLUNGA
FOR INSTALLATIONS ON DRYWALL, CHECK THE DIMENSIONS OF THE PANEL AND ORDER THE NECESSARY EXTENSION

5205/3/B/E + 894001

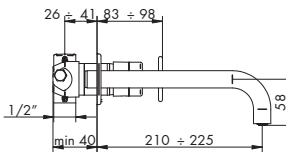
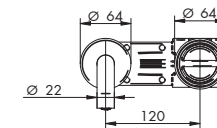
MISCELATORE LAVABO DA PARETE BOCCA PROLUNGATA
WALL BASIN MIXER EXTENDED SPOUT

- > cartuccia tradizionale
- > interasse bocca min 185 - max 210
- > limitatore di portata 5l/min 3bar
- > ingressi da 1/2"
- > senza scarico
- > rosoni separati



PARTI ESTERNE - CROMATO

01-5205/3/B/E €

PARTE INCASSO

01-894001 info pag. 30 €

PREZZO TOTALE €

PARTI ESTERNE - ALTRE FINITURE

XX-5205/3/B/E € x M*



PER INSTALLAZIONI SU PARETI IN CARTONGESSO VERIFICARE LE DIMENSIONI DEL PANNELLO E ORDINARE LA NECESSARIA PROLUNGA
FOR INSTALLATIONS ON DRYWALL, CHECK THE DIMENSIONS OF THE PANEL AND ORDER THE NECESSARY EXTENSION

5205/3/E + 894001

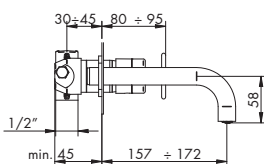
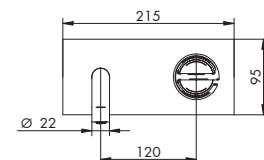
MISCELATORE LAVABO DA PARETE SU PIASTRA
WALL BASIN MIXER ON PLATE

- > cartuccia tradizionale
- > interasse bocca min 157 - max 172
- > limitatore di portata 5l/min 3bar
- > ingressi da 1/2"
- > senza scarico
- > piastra unica rettangolare



PARTI ESTERNE - CROMATO

01-5205/3/E €

PARTE INCASSO

01-894001 info pag. 30 €

PREZZO TOTALE €

PARTI ESTERNE - ALTRE FINITURE

XX-5205/3/E € x M*



PER INSTALLAZIONI SU PARETI IN CARTONGESSO VERIFICARE LE DIMENSIONI DEL PANNELLO E ORDINARE LA NECESSARIA PROLUNGA
FOR INSTALLATIONS ON DRYWALL, CHECK THE DIMENSIONS OF THE PANEL AND ORDER THE NECESSARY EXTENSION

5205/3/1/E + 894001

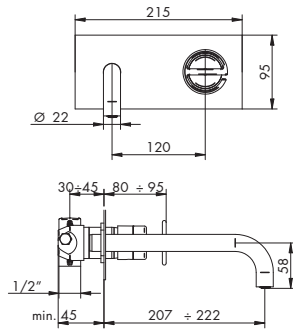
MISCELATORE LAVABO DA PARETE SU PIASTRA BOCCA PROLUNGATA
WALL BASIN MIXER EXTENDED SPOUT ON PLATE

- > cartuccia tradizionale
- > interasse bocca min 207 - max 222
- > limitatore di portata 5l/min 3bar
- > ingressi da 1/2"
- > senza scarico
- > piastra unica rettangolare



0136/U p. 880



0133/L p. 879

PARTI ESTERNE - CROMATO

01-5205/3/1/E €

PARTE INCASSO

01-894001 info pag. 30 €

PREZZO TOTALE €**PARTI ESTERNE - ALTRE FINITURE**

XX-5205/3/1/E € x M*



PER INSTALLAZIONI SU PARETI IN CARTONGESSO VERIFICARE LE DIMENSIONI DEL PANNELLO E ORDINARE LA NECESSARIA PROLUNGA
 FOR INSTALLATIONS ON DRYWALL, CHECK THE DIMENSIONS OF THE PANEL AND ORDER THE NECESSARY EXTENSION



525001



025002

5205/R/A

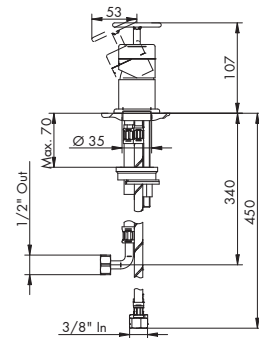
MISCELATORE REMOTO
REMOTE MIXER

- > cartuccia tradizionale
- > flessibili di alimentazione
- > senza scarico
- > abbinare a rubinetto sottolavabo con filtro (art. 020)



0136/U p. 880



0133/L p. 879

CROMATO

01-5205/R/A €

ALTRE FINITURE

XX-5205/R/A € x M*



025002

5205/R/B/E + 104033

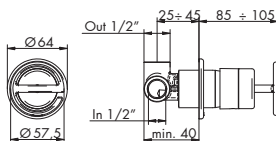
MISCELATORE INCASSO REMOTO
BUILT-IN REMOTE MIXER

- > cartuccia tradizionale
- > ingressi da 1/2"
- > uscita superiore
- > senza scarico
- > utilizzabile anche come incasso doccia



0136/U p. 880



0133/L p. 879

PARTI ESTERNE - CROMATO

01-5205/R/B/E €

PARTE INCASSO

01-104033 info pag. 27 €

PREZZO TOTALE €**PARTI ESTERNE - ALTRE FINITURE**

XX-5205/R/B/E € x M*



025002

104009 | 104010 | 104011

KIT PROLUNGA MIX INCASSO
BUILT-IN MIXER EXTENSION KIT

- > lunghezza 2 cm, 3 cm, 4 cm
- > kit fondello prolunga cartuccia miscelatore + bicchiere esterno sostitutivo in finitura
- > per art. 5205/R/B/E, 5205/3/A/E, 5205/3/B/E, 5205/3/E, 5205/3/1/E

CROMATO

01-104009 2 cm €

01-104010 3 cm €

01-104011 4 cm €

ALTRE FINITURE

XX-104009 2 cm € x M*

XX-104010 3 cm € x M*

XX-104011 4 cm € x M*

* MOLTIPLICATORE RICAMBI
 * MULTIPLIER "RICAMBI"

524023 | 524024

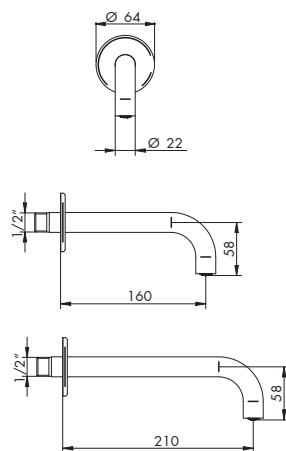
BOCCA LAVABO DA PARETE
WALL BASIN SPOUT

- > interasse bocca 160 / 210 mm
- > attacco da 1/2"
- > rosone Ø64



0136/U p. 880



0133/L p. 879

CROMATO

01-524023	160 mm	€
01-524024	210 mm	€

ALTRE FINITURE

XX-524023	160 mm	€	x M*
XX-524024	210 mm	€	x M*



525001

5207/7/S

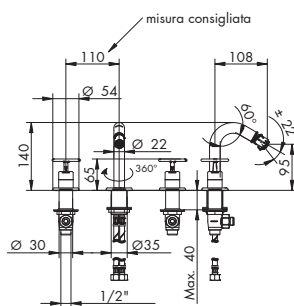
BATTERIA BIDET TRE FORI BOCCA GIREVOLE
3 HOLE BIDET SWINGING SPOUT

- > vitone ceramico 90°
- > interasse bocca 108
- > bocca girevole 360°
- > limitatore di portata 5l/min 3bar
- > senza flessibili di alimentazione
- > senza scarico



029 p. 893



0136/U p. 880



011/B p. 887

CROMATO

01-5207/7/S	€
-------------	---

ALTRE FINITURE

XX-5207/7/S	€	x M*
-------------	---	------

524008
01- cromato / XX- finitura

605007

5207/2/S

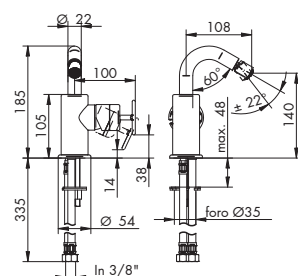
MISCELATORE BIDET MONOFORO LEVA LATERALE BOCCA GIREVOLE
BIDET MIXER SWINGING SPOUT

- > cartuccia tradizionale
- > interasse bocca 108
- > bocca girevole 360°
- > limitatore di portata 5l/min 3bar
- > flessibili di alimentazione
- > senza scarico
- > abbinare a rubinetto sottolavabo con filtro (art. 020)



0136/U p. 880



011/B p. 887

CROMATO

01-5207/2/S	€
-------------	---

ALTRE FINITURE

XX-5207/2/S	€	x M*
-------------	---	------

524008
01- cromato / XX- finitura

025002

524026

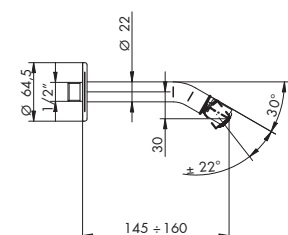
BOCCA BIDET DA PARETE
WALL BIDET SPOUT

- > interasse min 145 - max 160
- > aeratore snodato
- > limitatore di portata 5 l/min 3 Bar
- > attacco da 1/2"
- > rosone Ø64



0136/U p. 880



011/B p. 887

CROMATO

01-524026	€
-----------	---

ALTRE FINITURE

XX-524026	€	x M*
-----------	---	------

524008
01- cromato / XX- finitura

5200/E + 104002

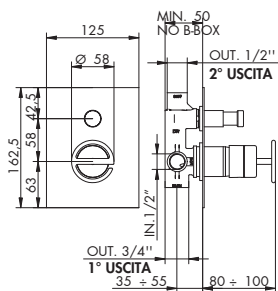

INCASSO
UNIVERSALE
CON B-BOX

MISCELATORE INCASSO C/DEVIATORE AUTOMATICO 2 USCITE
BUILT-IN MIXER WITH AUTOMATIC DIVERTER 2 OUT

- > cartuccia tradizionale
- > deviatore a pressione 2 uscite c/ritorno automatico e blocco meccanico basse pressioni
- > piastra rettangolare
- > uscita principale inferiore da 3/4"
- > incasso con B-BOX
- > attacchi da 1/2"



PILETTA DOCCIA
SHOWER WASTE
8816/E + 775025
p. 888

PARTI ESTERNE - CROMATO

01-5200/E €

PARTI ESTERNE - ALTRE FINITURE

XX-5200/E € x M*

PARTE INCASSO

01-104002 info pag. 33 €

PREZZO TOTALE €

PER INSTALLAZIONI SU PARETI IN CARTONGESSO VERIFICARE LE DIMENSIONI DEL PANNELLO E ORDINARE LA NECESSARIA PROLUNGA
FOR INSTALLATIONS ON DRYWALL, CHECK THE DIMENSIONS OF THE PANEL AND ORDER THE NECESSARY EXTENSION



105029



025002

5200/1/P/E + 724027

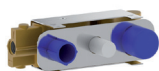

INCASSO
UNIVERSALE

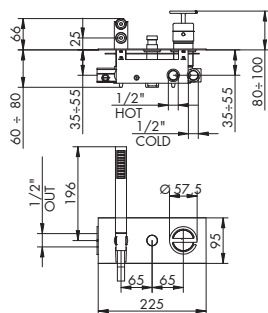
MISCELATORE INCASSO C/DEVIATORE AUTOMATICO E DOCCETTA
BUILT-IN MIXER WITH AUTOMATIC DIVERTER AND HAND SHOWER

- > cartuccia tradizionale
- > deviatore a pressione 2 uscite c/ritorno automatico e blocco meccanico basse pressioni
- > attacchi da 1/2" > flessibile PVC 150 cm
- > uscita principale fianco sinistro
- > doccetta monogetto cilindrica in ABS c/anticalcare, per finiture diverse da cromo doccetta in metallo



PILETTA DOCCIA
SHOWER WASTE
8816/E + 775025
p. 888

PARTI ESTERNE - CROMATO

01-5200/1/P/E

PARTI ESTERNE - ALTRE FINITURE

XX-5200/1/P/E x M*

PARTE INCASSO

01-724027 info pag. 35

PREZZO TOTALE

PER INSTALLAZIONI SU PARETI IN CARTONGESSO VERIFICARE LE DIMENSIONI DEL PANNELLO E ORDINARE LA NECESSARIA PROLUNGA
FOR INSTALLATIONS ON DRYWALL, CHECK THE DIMENSIONS OF THE PANEL AND ORDER THE NECESSARY EXTENSION



724030



025002

104006 | 104007 | 104008

KIT PROLUNGA MIX INCASSO CON DEVIAZIONE
BUILT-IN MIXER EXTENSION KIT WITH DIVERTER

- > lunghezza 2 cm, 3 cm, 4 cm
- > kit fondello prolunga cartuccia miscelatore e albero deviatore
- + bicchieri esterni sostitutivi in finitura
- > per art.: 5200/E, 5200/1/P/E

CROMATO

01-104006 2 cm €

01-104007 3 cm €

01-104008 4 cm €

ALTRE FINITURE

XX-104006 2 cm € x M*

XX-104007 3 cm € x M*

XX-104008 4 cm € x M*

* MOLTIPLICATORE RICAMBI
* MULTIPLIER "RICAMBI"

5203/2/1/E + 914016

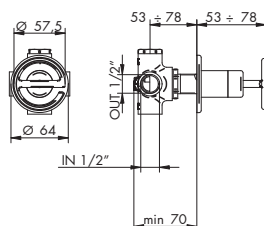
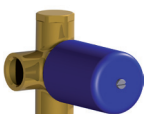
DEVIATORE INCASSO 2 USCITE
BUILT-IN DIVERTER 2 OUT

- > deviatore a dischi ceramici 2 uscite senza chiusura
- > attacchi da 1/2"
- > abbinare a miscelatore o rubinetti d'arresto

PARTI ESTERNE - CROMATO

01-5203/2/1/E

PARTI ESTERNE - ALTRE FINITURE

XX-5203/2/1/E x M*

PARTE INCASSO

914016 info pag. 36

PREZZO TOTALE



635010

5203/3/1/E + 034127

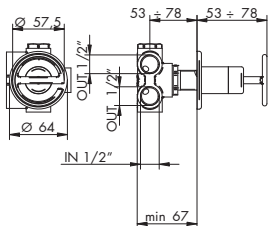
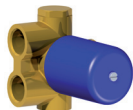

DEVIATORE INCASSO 3 USCITE
BUILT-IN DIVERTER 3 OUT

- > deviatore a dischi ceramici 3 uscite senza chiusura
- > attacchi da 1/2"
- > abbinare a miscelatore o rubinetti d'arresto

PARTI ESTERNE - CROMATO	
01-5203/3/1/E	€
PARTE INCASSO	
034127	info pag. 36 €
PREZZO TOTALE	€

PARTI ESTERNE - ALTRE FINITURE	
XX-5203/3/1/E	€ x M*



5203/4/1/E + 034128

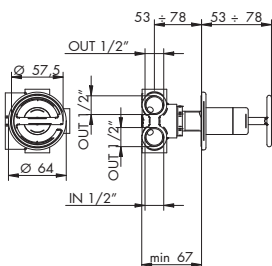
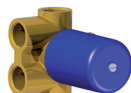

DEVIATORE INCASSO 4 USCITE
BUILT-IN DIVERTER 4 OUT

- > deviatore a dischi ceramici 4 uscite senza chiusura
- > attacchi da 1/2"
- > abbinare a miscelatore o rubinetti d'arresto

PARTI ESTERNE - CROMATO	
01-5203/4/1/E	€
PARTE INCASSO	
034128	info pag. 36 €
PREZZO TOTALE	€

PARTI ESTERNE - ALTRE FINITURE	
XX-5203/4/1/E	€ x M*



5212/P/E + 484020

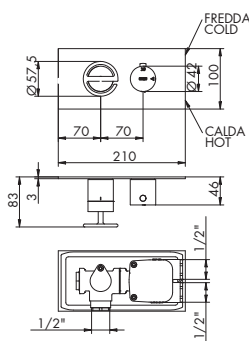
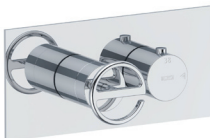

MISCELATORE TERMOSTATICO INCASSO 1 USCITA
BUILT-IN THERMOSTATIC MIXER 1 OUT

- > cartuccia termostatica
- > vitone ceramico 90°
- > apertura con rotazione antioraria
- > ingressi su lato destro da 1/2"
- > incasso con B-BOX
- > posizionabile verticalmente
- > interasse 70 mm
- > uscita superiore da 1/2"
- > incasso regolabile min 76
- > piastra unica rettangolare

PARTI ESTERNE - CROMATO	
01-5212/P/E	€
PARTE INCASSO	
484020	info pag. 37 €
PREZZO TOTALE	€

PARTI ESTERNE - ALTRE FINITURE	
XX-5212/P/E	€ x M*



INCASSO UNIVERSALE CON B-BOX



PER INSTALLAZIONI SU PARETI IN CARTONGESSO VERIFICARE LE DIMENSIONI DEL PANNELLO E ORDINARE LA NECESSARIA PROLUNGA
FOR INSTALLATIONS ON DRYWALL, CHECK THE DIMENSIONS OF THE PANEL AND ORDER THE NECESSARY EXTENSION



5212/2/P/E + 484021

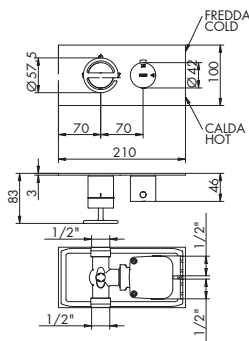
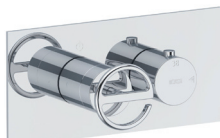

MISCELATORE TERMOSTATICO INCASSO C/DEVIATORE 2 USCITE
BUILT-IN THERMOSTATIC MIXER WITH DIVERTER 2 OUT

- > cartuccia termostatica
- > deviatore a dischi ceramici 2 uscite c/chiusura
- > interasse 70 mm
- > ingressi su lato destro da 1/2"
- > uscite superiori ed inferiori da 1/2"
- > incasso con B-BOX
- > incasso regolabile min 76
- > piastra unica rettangolare

PARTI ESTERNE - CROMATO	
01-5212/2/P/E	€
PARTE INCASSO	
484021	info pag. 37 €
PREZZO TOTALE	€

PARTI ESTERNE - ALTRE FINITURE	
XX-5212/2/P/E	€ x M*



INCASSO UNIVERSALE CON B-BOX



PER INSTALLAZIONI SU PARETI IN CARTONGESSO VERIFICARE LE DIMENSIONI DEL PANNELLO E ORDINARE LA NECESSARIA PROLUNGA
FOR INSTALLATIONS ON DRYWALL, CHECK THE DIMENSIONS OF THE PANEL AND ORDER THE NECESSARY EXTENSION



5212/3/P/E + 484022

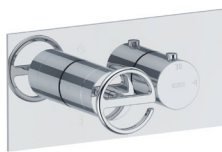

INCASSO
UNIVERSALE
CON B-BOX

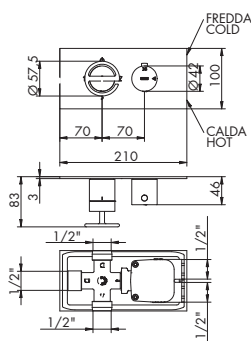
MISCELATORE TERMOSTATICO INCASSO C/DEVIATORE 3 USCITE
BUILT-IN THERMOSTATIC MIXER WITH DIVERTER 3 OUT

- > cartuccia termostatica
- > deviatore a dischi ceramici 3 uscite c/chiusura
- > interasse 70 mm > ingressi su lato destro da 1/2"
- > uscite superiori ed inferiori da 1/2"
- > incasso con B-BOX > incasso regolabile min 76
- > piastra unica rettangolare



PILETTA DOCCIA
SHOWER WASTE

8816/E + 775025
p. 888

PARTI ESTERNE - CROMATO

01-5212/3/P/E €

PARTI ESTERNE - ALTRE FINITURE

XX-5212/3/P/E € x M*

PARTE INCASSO

484022 info pag. 37 €

PREZZO TOTALE €



PER INSTALLAZIONI SU PARETI IN CARTONGESSO VERIFICARE LE DIMENSIONI DEL PANNELLO E ORDINARE LA NECESSARIA PROLUNGA
FOR INSTALLATIONS ON DRYWALL, CHECK THE DIMENSIONS OF THE PANEL AND ORDER THE NECESSARY EXTENSION



CARTUCCIA
DEVIATRICE
DIVERTER CARTRIDGE
035345



CART. TERMOSTATICA
THERMOSTATIC
CARTRIDGE
775007

5212/4/P/E + 484023

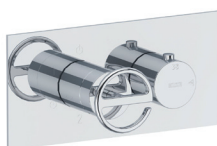

INCASSO
UNIVERSALE
CON B-BOX

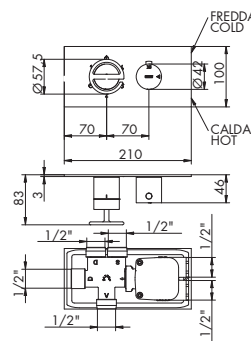
MISCELATORE TERMOSTATICO INCASSO C/DEVIATORE 4 USCITE
BUILT-IN THERMOSTATIC MIXER WITH DIVERTER 4 OUT

- > cartuccia termostatica
- > deviatore a dischi ceramici 4 uscite c/doppia chiusura
- > interasse 70 mm > ingressi su lato destro da 1/2"
- > uscite superiori ed inferiori da 1/2"
- > incasso con B-BOX > incasso regolabile min 76
- > piastra unica rettangolare



PILETTA DOCCIA
SHOWER WASTE

8816/E + 775025
p. 888

PARTI ESTERNE - CROMATO

01-5212/4/P/E €

PARTI ESTERNE - ALTRE FINITURE

XX-5212/4/P/E € x M*

PARTE INCASSO

484023 info pag. 38 €

PREZZO TOTALE €



PER INSTALLAZIONI SU PARETI IN CARTONGESSO VERIFICARE LE DIMENSIONI DEL PANNELLO E ORDINARE LA NECESSARIA PROLUNGA
FOR INSTALLATIONS ON DRYWALL, CHECK THE DIMENSIONS OF THE PANEL AND ORDER THE NECESSARY EXTENSION



CARTUCCIA
DEVIATRICE
DIVERTER CARTRIDGE
035344



CART. TERMOSTATICA
THERMOSTATIC
CARTRIDGE
775007

094021 | 094025

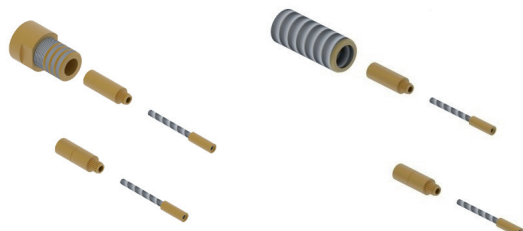
KIT PROLUNGA MIX INCASSO TERMOSTATICO
BUILT-IN THERMOSTATIC MIXER EXTENSION KIT

- > lunghezza 3 cm
- > 094021 per art. 5212/2/P/E, 5212/3/P/E, 5212/4/P/E
- > 094025 per art. 5212/P/E

GREZZO

094021 2/3/4 out €

094025 1 out €

PER COMANDI TERMOSTATICI ALTA PORTATA, CONSULTARE
SEZIONE REVIVRE DA PAG. 326.

FOR HIGH FLOW RATE THERMOSTATIC MIXER, LOOK AT THE
"REVIVRE" COLLECTION FROM PAGE 326.



8812/H/P/E
+ 774035

1 OUT
ALTA PORTATA
HIGH FLOW RATE



8812/2H/P/E
+ 774036

2 OUT
ALTA PORTATA
HIGH FLOW RATE



8812/3H/P/E
+ 774033

3 OUT
ALTA PORTATA
HIGH FLOW RATE



8812/4H/P/E
+ 774034

4 OUT
ALTA PORTATA
HIGH FLOW RATE



8812/H/E
+ 884036

1 OUT
ALTA PORTATA
HIGH FLOW RATE



8812/2H/E
+ 884037

2 OUT
ALTA PORTATA
HIGH FLOW RATE



8812/3H/E
+ 884038

3 OUT
ALTA PORTATA
HIGH FLOW RATE



8812/4H/E
+ 884039

4 OUT
ALTA PORTATA
HIGH FLOW RATE

DOCCIA COMPLEMENTI CONSIGLIATI:
PER SOLUZIONI ALTERNATIVE E LISTINO PREZZI, CONSULTARE LA SEZIONE COMPLETA, DA PAG. 118.

SUGGESTED "DOCCIA COMPLEMENTI":
FOR ALTERNATIVE SOLUTIONS AND PRICE LIST, SEE THE COMPLETE COLLECTION FROM PAGE 118.



4403/1/A, 4403/1
SUPPORTO DOCCIA COMPLETO
FULL SHOWER SUPPORT



0530N
SALISCENDI COMPLETO C/PRESA D'ACQUA
COMPLETE WALL PIPE WITH WATER CONNECTION



0413/4/SP
STELO DOCCIA
ROD SHOWER



0413/5/1/SP
CURVA PRESA ACQUA C/STELO COMPLETO
CURVE WATER CONNECTOR WITH COMPLETE ROD

SOFFIONI E BRACCI CONSIGLIATI:
PER SOLUZIONI ALTERNATIVE E LISTINO PREZZI, CONSULTARE LA SEZIONE COMPLETA, DA PAG. 38.
PER COMPOSIZIONI DOCCIA CONSULTARE SEZIONE REVIVRE.

SUGGESTED "BRACCI E SOFFIONI":
FOR ALTERNATIVE SOLUTIONS AND PRICE LIST, SEE THE COMPLETE COLLECTION FROM PAGE 38.
FOR SHOWER TYPESETTING LOOK AT "REVIVRE" COLLECTION.



4831/A/P INOX
SOFFIONE Ø200 DA PARETE CON BRACCIO
WALL SHOWER DIAMETER 200 WITH ARM

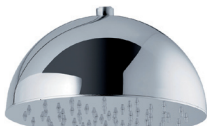

035383 INOX
SOFFIONE Ø 300 A CAMPANA
BELL CEILING DIAMETER 300



884055
BRACCIO DA PARETE MM 350
WALL ARM MM 350



044054
BRACCIO A SOFFITTO MM 250
CEILING ARM MM 250

COMPONI IL TUO SET DOCCIA:
PER SOLUZIONI ALTERNATIVE E LISTINO PREZZI, CONSULTARE LA SEZIONE COMPLETA, DA PAG. 186.

DESIGN YOUR SHOWER SET:
FOR ALTERNATIVE SOLUTIONS AND PRICE LIST, SEE THE COMPLETE COLLECTION FROM PAGE 186.



014083
GANCIO INCASSO FISSO
BUILT-IN FIXED HOOK



014084
SUPPORTO ESTERNO FISSO
EXTERNAL FIXED SUPPORT



445043 OTTONE
DOCCETTA MONOGETTO
MONO JET HAND SHOWER



915001 ABS
DOCCETTA MONOGETTO
MONO JET HAND SHOWER



915003
FLESSIBILE TUBO PVC L150 CM
PVC TUBE FLEXIBLE L150 CM



655016
FLESSIBILE TRECCIA OTTONE L150 CM
BRASS FLEXIBLE L150 CM



0530/1N
ASTA SALISCENDI
WALL PIPE

5200/2/P/E + 724028

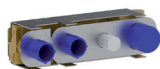

INCASSO UNIVERSALE

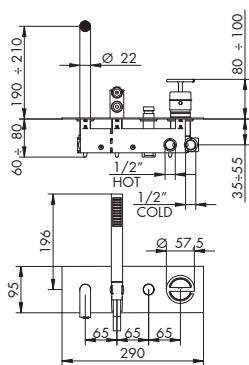

MISCELATORE INCASSO C/DEVIATORE AUTOMATICO, DOCCETTA E BOCCA
BUILT-IN MIXER WITH AUTOMATIC DIVERTER HAND SHOWER AND SPOUT

- > cartuccia tradizionale
- > interasse bocca min 190 - max 210
- > deviatore a pressione 2 uscite c/ritorno automatico e blocco meccanico basse pressioni
- > attacchi da 1/2" > flessibile PVC 150 cm
- > doccetta monogetto cilindrica in ABS c/anticalcare, per finiture diverse da cromo doccetta in metallo



012 p. 888

PARTI ESTERNE - CROMATO

01-5200/2/P/E

PARTE INCASSO

01-724028 info pag. 39

PREZZO TOTALE

PARTI ESTERNE - ALTRE FINITURE

XX-5200/2/P/E

x M*



PER INSTALLAZIONI SU PARETI IN CARTONGESSO VERIFICARE LE DIMENSIONI DEL PANNELLO E ORDINARE LA NECESSARIA PROLUNGA
FOR INSTALLATIONS ON DRYWALL, CHECK THE DIMENSIONS OF THE PANEL AND ORDER THE NECESSARY EXTENSION



AERATORE C/CHIAVE
AERATOR W/KEY
525003



DEVIATORE
DIVERTER
724030



CARTUCCIA
CARTRIDGE
025002

104006 | 104007 | 104008

KIT PROLUNGA MIX INCASSO CON DEVIAZIONE
BUILT-IN MIXER EXTENSION KIT WITH DIVERTER

- > lunghezza 2 cm, 3 cm, 4 cm
- > kit fondello prolunga cartuccia miscelatore e albero deviatore
- + bicchieri esterni sostitutivi in finitura
- > per art.: 5200/2/P/E



CROMATO		€
01-104006	2 cm	€
01-104007	3 cm	€
01-104008	4 cm	€

ALTRE FINITURE		€	x M*
XX-104006	2 cm	€	x M*
XX-104007	3 cm	€	x M*
XX-104008	4 cm	€	x M*

* MOLTIPLICATORE RICAMBI
 * MULTIPLIER "RICAMBI"

5203

BOCCA VASCA DA PARETE
WALL BATH SPOUT

- > interasse min 155 - max 170
- > attacchi da 1/2"

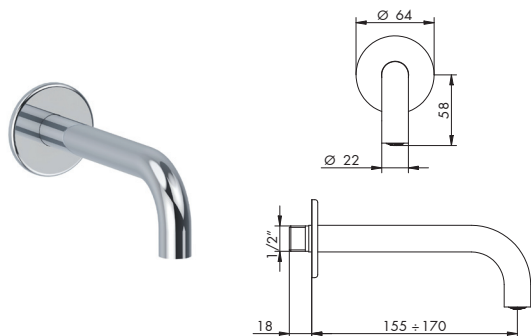

012 p. 888

CROMATO	€
01-5203	€

ALTRE FINITURE	€	x M*
XX-5203	€	x M*



525003

044071

SUPPORTO DOCCIA BV TONDO COMPLETO
COMPLETE ROUND HAND SHOWER SET FOR BATH RIM

- > flessibile in PVC 150 cm
- > attacco da 1/2"
- > doccetta monogetto cilindrica in ABS c/anticalcare, per finiture diverse da cromo doccetta in metallo

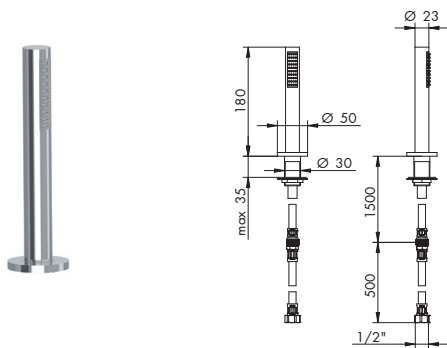

CROMATO	€
01-044071	€

ALTRE FINITURE	€	x M^
XX-044071	€	x M^

^ MOLTIPLICATORE DOCCIA COMPLEMENTI
 ^ MULTIPLIER "DOCCIA COMPLEMENTI"

5208/E + 604003

RUBINETTO D'ARRESTO 1/2"
BUILT-IN STOP COCK 1/2"

- > vitone ceramico 90°
- > ingressi da 1/2"

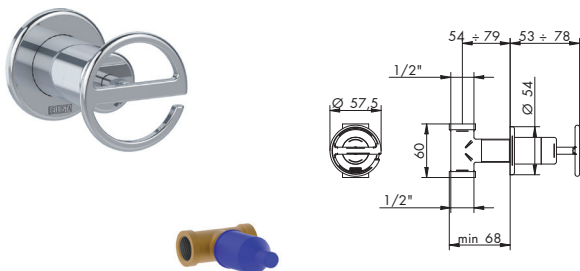

PARTI ESTERNE - CROMATO		€
01-5208/E		€
PARTE INCASSO		€
604003	info pag. 41	€
PREZZO TOTALE		€

PARTI ESTERNE - ALTRE FINITURE		€	x M*
XX-5208/E		€	x M*



605007

5208/E + 604005

RUBINETTO D'ARRESTO 3/4"
BUILT-IN STOP COCK 3/4"

> vitone ceramico 90°
> ingressi da 3/4"

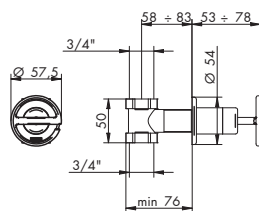

PARTI ESTERNE - CROMATO

01-5208/E €

PARTE INCASSO

604005 info pag. 41 €

PREZZO TOTALE €

PARTI ESTERNE - ALTRE FINITURE

XX-5208/E € x M*

VITONE CERAMICO
CERAMIC VALVE

605007



ELECTA

**AERATORI C/CHIAVE
AERATORS AND KEY**

525001 senza finitura

525003 senza finitura

**SNODINO AERATORE
JOINTS WITH AERATOR**

01-524008 cromato

XX- 524008 altre finiture**CARTUCCE
CARTRIDGES**

025002 senza finitura

**DEVIATORI
DIVERTERS**

105029 senza finitura

724030 senza finitura

**CARTUCCE TERMOSTATICHE
THERMOSTATIC CARTRIDGES**

775007 senza finitura

**CARTUCCE DEVIATRICI
DIVERTER CARTRIDGES**

035344 senza finitura

035345 senza finitura

035346 senza finitura

635010 senza finitura

635011 senza finitura

635012 senza finitura

**VITONI CERAMICI
CERAMIC VALVES**

055134 senza finitura

605007 senza finitura



ELECTA