

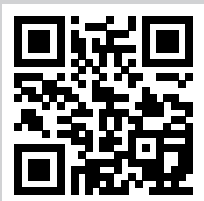

REVIVRE collection

INFO TECNICHE pag. 187

TABELLA PREZZI FINITURE pag. 188



CONSULTA LISTINO ON LINE
CHECK ON LINE PRICE LIST

www.bellostarubinetterie.com/online/10_componi_setdoccia.pdf

INDICE | INDEX

ASTE SALISCENDI pag. 189

PRESE D'ACQUA pag. 201

GANCI FISSI pag. 207

GANCI DUPLEX pag. 217

DOCCETTE pag. 227

FLESSIBILI pag. 237

COMPONI SET DOCCIA

EQB DESIGN

PROGETTO SU MISURA: RICHIESTE SPECIALI

I tecnici di Bellosta Rubinetterie sono, inoltre, a disposizione di architetti e designers, per offrire un servizio esclusivo: personalizzazioni di elementi in funzione di specifiche richieste estetiche o problematiche legate a vincoli progettuali, verifica della fattibilità attraverso opportuni studi CAD e sviluppo del disegno tecnico del prodotto speciale richiesto.

Per informazioni e richieste PROGETTI SU MISURA:
ufficiotecnico@bellostarubinetterie.com

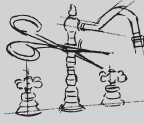

PROGETTO SU MISURA: SPECIAL REQUESTS

Engineers Bellosta Rubinetterie are also available to architects and designers, to offer an exclusive service: customizations of items according to specific aesthetic requirements or issues related to design constraints, verification of the feasibility studies and development through appropriate CAD technical design the required special product. For information and requests "SU MISURA" PROJECTS:
ufficiotecnico@bellostarubinetterie.com









progetto
"sumisura"

LEVE E INSERTI

Le leve e gli inserti (impugnatura ed erogatore doccetta, leva saliscendi, etc.) della collezione BELLINI sono disponibili, **senza variazione di prezzo**, in:

LEVERS AND INSERTS

Levers and inserts (handle and hand shower, sliding lever, etc.) of BELLINI collection are available **without price change** in:

	finitura -XX	bianco opaco -66	nero opaco -67
STILO STILO			
DOCCETTA HANDSHOWER	 erogatore ABS grigio  impugnatura in finitura	 erogatore ABS bianco  impugnatura bianco opaco	 erogatore ABS nero  impugnatura nero opaco



COMPONI
SET
DOCCIA

PREZZO FINITURE

Calcola il prezzo di listino (IVA esclusa) delle finiture diverse dal cromato, consultando la seguente tabella.

Moltiplicare il **PREZZO LISTINO** per il **COEFFICIENTE MOLTIPLICATORE** della finitura scelta, arrotondando per difetto il prezzo ottenuto (eliminare i centesimi).
ESEMPIO per ordinare art. 1030/1 in finitura dorato: codice 04-1030/1

$$€ 161,00 \text{ (PREZZO LISTINO)} \times 2,20 \text{ (MOLTIPLICATORE)} = € 354,20 \quad 354,00$$

PRICE FINISHES

Include the list price (excluding VAT) of different finishes from chrome, consulting the following table. Multiply the **PRICE LIST MULTIPLIER COEFFICIENT** of the chosen finish, reducing the price obtained by deleting the centesim.

EXAMPLE to order art. 1030/1 gold finish: code 04-1030/1

$$€ 161,00 \text{ (LIST PRICE)} \times 2,20 \text{ (MULTIPLIER)} = € 354,20 \quad 354,00$$

COMPOSIZIONE CODICE PER ORDINARE ARTICOLO IN FINITURA



CODICE FINITURA
FINISH CODE

CODICE ARTICOLO
ITEM NUMBER

MOLTIPLICATORI FINITURE DI SERIE
STANDARD FINISHES MULTIPLIERS

COD. CODE	DESCRIZIONE FINITURA FINISH DESCRIPTION	GRUPPO 1	GRUPPO 2	GRUPPO 3
01-	cromato/chrome	PREZZO LISTINO°		

MOLTIPLICATORI FINITURE A RICHIESTA
ON REQUEST FINISHES MULTIPLIERS

COD. CODE	DESCRIZIONE FINITURA FINISH DESCRIPTION	GRUPPO 1	GRUPPO 2	GRUPPO 3
02-	cromo/oro/chrome/gold			
03-	oro/argento/gold/silver			
04-	dorato/gold			
05-	bronzo satinato/satin bronze			
06-	rame vecchio/old copper			
07-	vecchio argento/old silver			
08-	canna di fucile/gun barrel			
10-	verderame/verdigris			
11-	nero antracite/anthracite black			
12-	ottone lucido/polished brass			
13-	ottone naturale/natural brass			
14-	bianco lucido/glossy white			
19-	nero lucido/glossy black			
28-	nickel satinato/satin nickel			
30-	nickel lucido/polished nickel			
33-	cromo satinato/satin chrome			
34-	cromo spazzolato/brushing chrome			
35-	nickel spazzolato/brushing nickel			
56-	avorio/ivory			
57-	azzurro/light blue			
58-	verdino/light green			

MOLTIPLICATORI FINITURE A RICHIESTA
ON REQUEST FINISHES MULTIPLIERS

COD. CODE	DESCRIZIONE FINITURA FINISH DESCRIPTION	GRUPPO 1	GRUPPO 2	GRUPPO 3
59-	marrone/brown			
60-	arancio/orange			
61-	rosso/red			
66-	bianco opaco/mat white			
67-	nero opaco/matt black			
68-	rame opaco/matt copper			
69-	argento opaco/matt silver			
71-	oro opaco/matt gold			
72-	bronzo opaco/matt bronze			
75-	dorato spazzolato/brushing gold			
87-	oro rosa/pink gold			
88-	ottone sisal/sisal brass			
89-	industrial			
92-	pomice opaco/matt pumice			
93-	arenaria opaco/matt sandstone			
94-	tuscany spazzolato/brushing tuscany			
95-	rame acidato/etched copper			
96-	cemento opaco/matt cement			
A1-	brina opaco/matt frost			
A2-	tuscany cerato/oilskin tuscany			
A3-	ottone acidato/etched brass			
A4-	basalto opaco/matt basalt			
B2-	black gun metal PVD			
B3-	nickel PVD			
B4-	matt gold PVD			

°PREZZO DI LISTINO PRICE LIST

* N.R. = NON REALIZZABILE NOT MADE

RICH. = PREZZO A RICHIESTA ON REQUEST PRICE

NOTE:

art. 915003 realizzabile nelle seguenti finiture:
 01,03,04,05,06,07,12,13,19,28,30,33,34,35,66,67,68,69,71,72,75,B2,B3,B4.
 Per altre finiture ordinare art. 655016 (prezzo di listino cromato € 40,00)

NOTE:

The art. 915003 si available in the following finishes:
 01,03,04,05,06,07,12,13,19,28,30,33,34,35,66,67,68,69,71,72,75,B2,B3,B4.
 For other colors order the art. 655016 (chrome price-list € 40,00)

ATTENZIONE! 13-OTTONE NATURALE e 88-OTTONE SISAL: finiture non protette che antichizzano naturalmente ossidando a contatto con l'umidità atmosferica.
WARNING! 13-NATURAL BRASS and 88-SISAL BRASS: unprotected finishes that naturally oxidise in contact with atmospheric humidity.

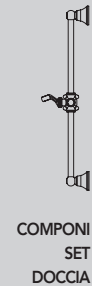

ASTE SALISCENDI

EQB DESIGN

INDICE | INDEX

ROSONE SAGOMATO	pag.	190/192
ROSONE TONDO	pag.	193/194
ROSONE OVALE	pag.	195
ROSONE QUADRO	pag.	196/197
ROSONE CLASSIC	pag.	198/199



ASTE
SALI-
SCENDI

1030/1

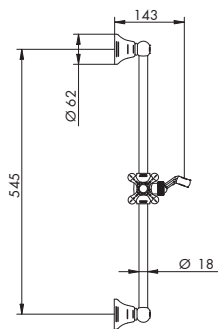

ASTA SALISCENDI
WALL PIPE

> supporto doccia scorrevole snodato

CROMATO	
01-1030/1	€

ALTRE FINITURE - GRUPPO 1	
XX-1030/1	€

0830/1

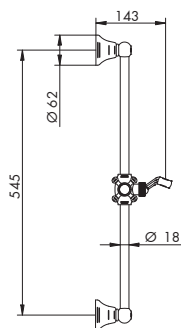

ASTA SALISCENDI
WALL PIPE

> supporto doccia scorrevole snodato

CROMATO	
01-0830/1	€

ALTRE FINITURE - GRUPPO 1	
XX-0830/1	€

4030/1

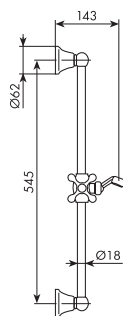

ASTA SALISCENDI
WALL PIPE

> supporto doccia scorrevole snodato
> maniglia a croce porcellana decorata o bianca

CROMATO	
01-4030/1	decorata €
01-4030/1/B	bianca €

ALTRE FINITURE - GRUPPO 1	
XX-4030/1	decorata €
XX-4030/1/B	bianca €

ASTE SALISCENDI

0830/1/L

ASTA SALISCENDI
WALL PIPE

- > supporto doccetta scorrevole snodato
- > leva con inserto in porcellana o legno

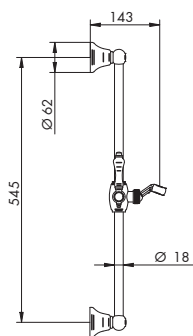

CROMATO

01-0830/1/L	porcellana	€
01-0830/1/LL	legno noce	€

ALTRE FINITURE - GRUPPO 1

XX-0830/1/L	porcellana	€
XX-0830/1/LL	legno noce	€

5730/1L

ASTA SALISCENDI
WALL PIPE

- > supporto doccetta scorrevole snodato
- > maniglia LEVER

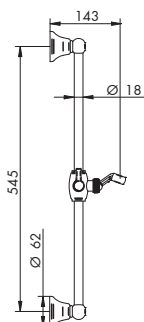

CROMATO

01-5730/1L	€
------------	---

ALTRE FINITURE - GRUPPO 1

XX-5730/1L	€
------------	---

5730/1

SALISCENDI COMPLETO C/PRESA D'ACQUA
COMPLETE WALL PIPE WITH WATER CONNECTION

- > supporto doccetta scorrevole snodato
- > maniglia a 6 punte

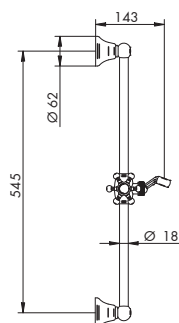

CROMATO

01-5730/1	€
-----------	---

ALTRE FINITURE - GRUPPO 1

XX-5730/1	€
-----------	---

7330/1

ASTA SALISCENDI
WALL PIPE

> supporto doccia scorrevole orientabile

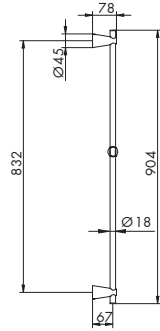

CROMATO
01-7330/1

€

ALTRE FINITURE - GRUPPO 1
XX-7330/1

€

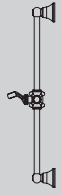

ASTE
SALI-
SCENDI

0530/1N

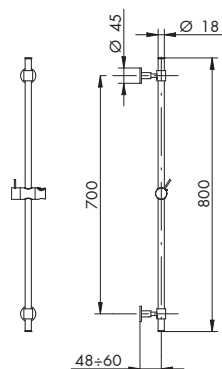

ASTA SALISCENDI
WALL PIPE

> supporto doccia scorrevole orientabile

CROMATO	
01-0530/1N	€

ALTRE FINITURE - GRUPPO 1	
XX-0530/1N	€

6330/1N

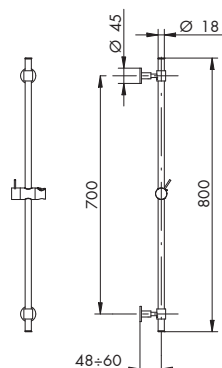

ASTA SALISCENDI
WALL PIPE

> supporto doccia scorrevole orientabile

CROMATO		
01-6330/1N-01	cromato	€
01-6330/1N-66	bianco op.	€
01-6330/1N-67	nero op.	€

ALTRE FINITURE - GRUPPO 1		
XX-6330/1N-XX	finitura	€
XX-6330/1N-66	bianco op.	€
XX-6330/1N-67	nero op.	€

4630/1

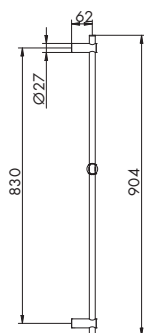

ASTA SALISCENDI
WALL PIPE

> supporto doccia scorrevole orientabile

CROMATO	
01-4630/1	€

ALTRE FINITURE - GRUPPO 1	
XX-4630/1	€



ASTE SALISCENDI

2730/1

ASTA SALISCENDI
WALL PIPE

> supporto doccetta scorrevole orientabile

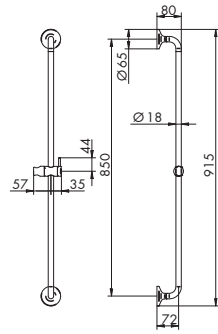

CROMATO
01-2730/1

€

ALTRE FINITURE - GRUPPO 1
XX-2730/1

€

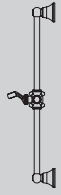

ASTE
SALI-
SCENDI

8030/1

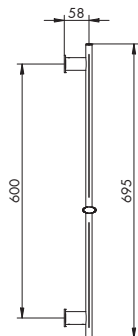

ASTA SALISCENDI
WALL PIPE

- > supporto doccia ovale scorrevole orientabile
- > stelo c/asta ovale

CROMATO	
01-8030/1	€

ALTRE FINITURE - GRUPPO 3	
XX-8030/1	€

8330/1

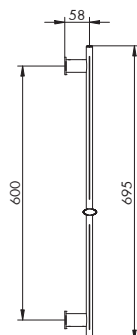

ASTA SALISCENDI C/SWAROVSKI
WALL PIPE WITH SWAROVSKI

- > supporto doccia scorrevole orientabile
- > maniglia scorrevole con SWAROVSKI

CROMATO	
01-8330/1	€

ALTRE FINITURE - GRUPPO 3	
XX-8330/1	€

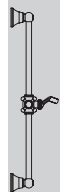

ASTE SALISCENDI

125074

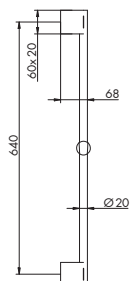

ASTA SALISCENDI
WALL PIPE

> supporto doccia scorrevole snodato

CROMATO
01-125074 €

NON DISPONIBILE IN ALTRE
FINITURE
NOT AVAILABLE IN OTHER
FINISHES

8030/1/A

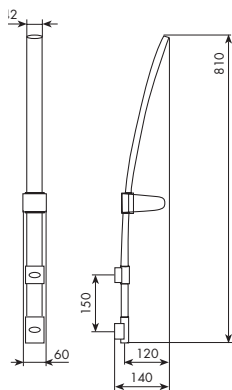

ASTA SALISCENDI
WALL PIPE

> supporto doccia scorrevole ABS

CROMATO
01-8030/1/A €

NON DISPONIBILE IN ALTRE
FINITURE
NOT AVAILABLE IN OTHER
FINISHES

7730/1

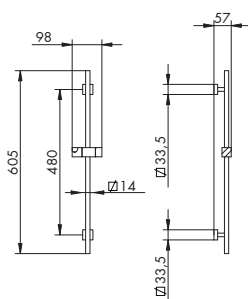

ASTA SALISCENDI
WALL PIPE

> supporto doccia quadro scorrevole orientabile
> stelo c/asta quadro

CROMATO
01-7730/1 €

NON DISPONIBILE IN ALTRE
FINITURE
NOT AVAILABLE IN OTHER
FINISHES

ASTE
SALI-
SCENDI

6530/1

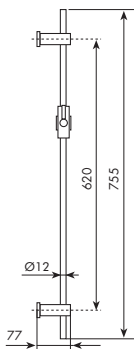

ASTA SALISCENDI
WALL PIPE

- > supporto doccia quadro scorrevole orientabile
- > stelo c/asta tonda supporti quadri

CROMATO	
01-6530/1	€

ALTRE FINITURE - GRUPPO 1	
XX-6530/1	€

0930/1N

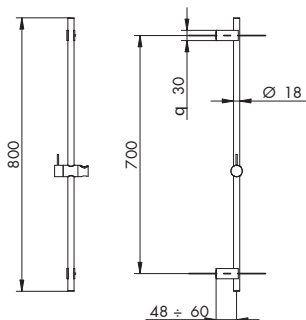

ASTA SALISCENDI
WALL PIPE

- > supporto doccia scorrevole orientabile

CROMATO	
01-0930/1N	€

ALTRE FINITURE - GRUPPO 1	
XX-0930/1N	€

3330/1

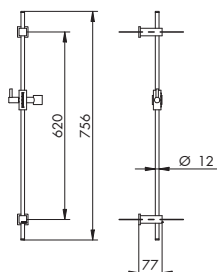

ASTA SALISCENDI C/SWAROVSKI
WALL PIPE WITH SWAROVSKI

- > supporto doccia quadro scorrevole orientabile con SWAROVSKI
- > stelo c/asta tonda supporti quadri

CROMATO	
01-3330/1	€

ALTRE FINITURE - GRUPPO 1	
XX-3330/1	€



ASTE SALISCENDI

1730/1

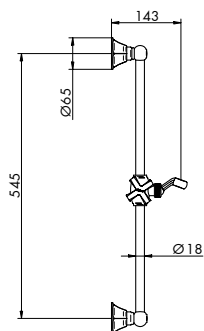

ASTA SALISCENDI
WALL PIPE

- > supporto doccia scorrevole snodato
- > maniglia a croce

CROMATO	
01-1730/1	€

ALTRE FINITURE - GRUPPO 1	
XX-1730/1	€

1430/1

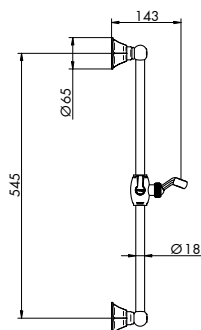

ASTA SALISCENDI
WALL PIPE

- > supporto doccia scorrevole snodato

CROMATO	
01-1430/1	€

ALTRE FINITURE - GRUPPO 1	
XX-1430/1	€

1830/1

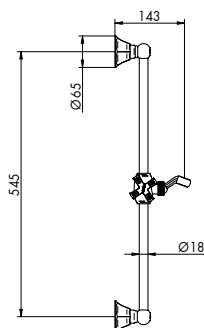

ASTA SALISCENDI C/SWAROVSKI
WALL PIPE WITH SWAROVSKI

- > supporto doccia scorrevole snodato
- > maniglia a croce con SWAROVSKI

CROMATO	
01-1830/1	€

ALTRE FINITURE - GRUPPO 1	
XX-1830/1	€

ASTE SALISCENDI

1630/1

ASTA SALISCENDI C/SWAROVSKI
WALL PIPE WITH SWAROVSKI

- > supporto doccetta scorrevole snodato
- > leva con SWAROVSKI

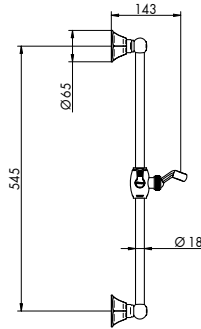

CROMATO
 01-1630/1 €

ALTRE FINITURE - GRUPPO 1
 XX-1630/1 €



ASTE
 SALI-
 SCENDI



ASTE
SALI-
SCENDI

PRESE D'ACQUA

EQB DESIGN

INDICE | INDEX

TONDA	pag.	202
OVALE	pag.	203
QUADRA	pag.	204
CLASSIC	pag.	205



PRESE
ACQUA

035111

PRESA D'ACQUA
WATER CONNECTION

> attacco da 1/2"

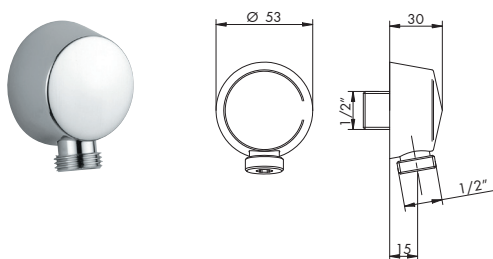

CROMATO
01-035111

€

ALTRE FINITURE - GRUPPO 2
XX-035111

€

734039

PRESA D'ACQUA
WATER CONNECTION

> attacco da 1/2"

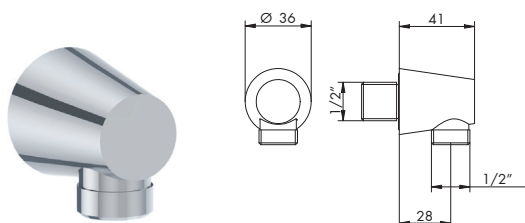

CROMATO
01-734039

€

ALTRE FINITURE - GRUPPO 2
XX-734039

€

274015

PRESA D'ACQUA
WATER CONNECTION

> attacco da 1/2"

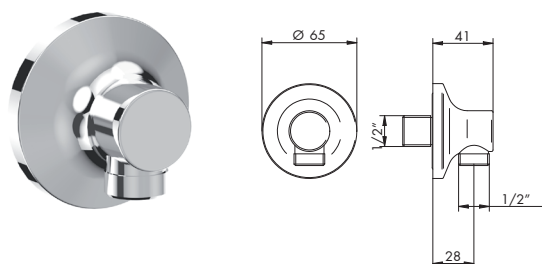

CROMATO
01-274015

€

ALTRE FINITURE - GRUPPO 2
XX-274015

€

805007

PRESA D'ACQUA OVALE
 OVAL WATER CONNECTION

> attacco da 1/2"

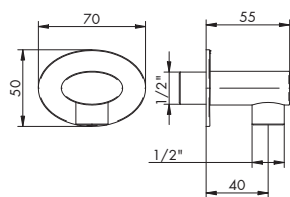

CROMATO
 01-805007 €

ALTRE FINITURE - GRUPPO 2
 XX-805007 €

834014

PRESA D'ACQUA OVALE C/SWAROVSKI
 OVAL WATER CONNECTION WITH SWAROVSKI

> attacco da 1/2"

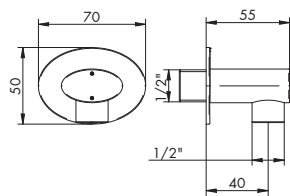

CROMATO
 01-834014 €

ALTRE FINITURE - GRUPPO 2
 XX-834014 €



PRESE
 ACQUA

655006

PRESA D'ACQUA QUADRA
 SQUARE WATER CONNECTION

> attacco da 1/2"

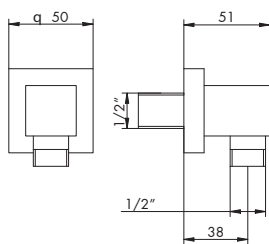

CROMATO
 01-655006

€

ALTRE FINITURE - GRUPPO 2
 XX-655006

€



PRESE
 ACQUA

144030

PRESA D'ACQUA CLASSIC
CLASSIC WATER CONNECTION

> attacco da 1/2"

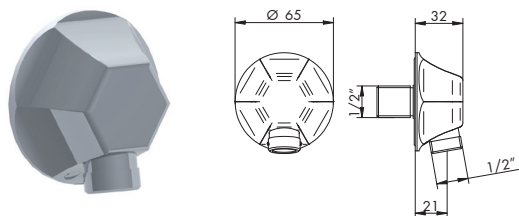

CROMATO

01-144030

€

ALTRE FINITURE - GRUPPO 2

XX-144030

€



PRESE
ACQUA



PRESE
ACQUA

INDICE | INDEX

TONDO ESTERNO	pag.	208
TONDO INCASSO	pag.	209
OVALE ESTERNO	pag.	210
OVALE INCASSO	pag.	211
QUADRO ESTERNO	pag.	212
QUADRO INCASSO	pag.	213/214
CLASSIC INCASSO	pag.	215



034076

GANCIO ESTERNO FISSO
EXTERNAL FIXED HOOK

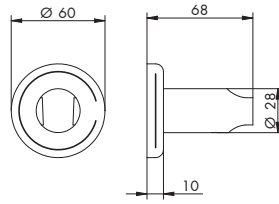

CROMATO
01-034076

€

ALTRE FINITURE - GRUPPO 2
XX-034076

€

014084

GANCIO ESTERNO FISSO
EXTERNAL FIXED HOOK

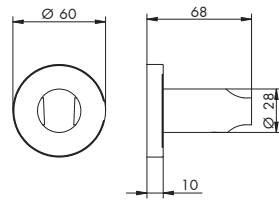

CROMATO
01-014084

€

ALTRE FINITURE - GRUPPO 2
XX-014084

€



GANCI
FISSI

034073

GANCIO INCASSO FISSO
BUILT-IN FIXED HOOK

> attacco da 1/2"

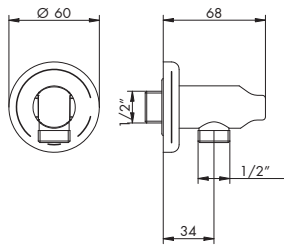

CROMATO	
01-034073	€

ALTRE FINITURE - GRUPPO 2	
XX-034073	€

014083

GANCIO INCASSO FISSO
BUILT-IN FIXED HOOK

> attacco da 1/2"

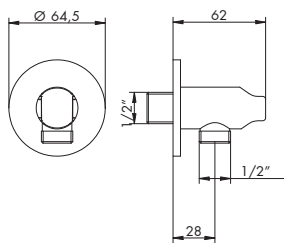

CROMATO	
01-014083	€

ALTRE FINITURE - GRUPPO 2	
XX-014083	€

274014

GANCIO INCASSO FISSO
BUILT-IN FIXED HOOK

> attacco da 1/2"

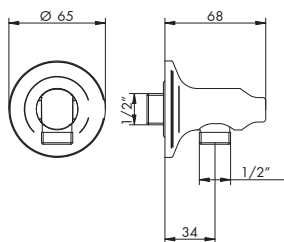

CROMATO	
01-274014	€

ALTRE FINITURE - GRUPPO 2	
XX-274014	€



GANCI
FISSI

805008

GANCIO ESTERNO FISSO
EXTERNAL FIXED HOOK

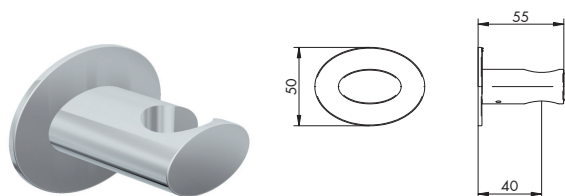

CROMATO	
01-805008	€

ALTRE FINITURE - GRUPPO 2	
XX-805008	€

834009

GANCIO ESTERNO FISSO C/SWAROVSKI
EXTERNAL FIXED HOOK WITH SWAROVSKI

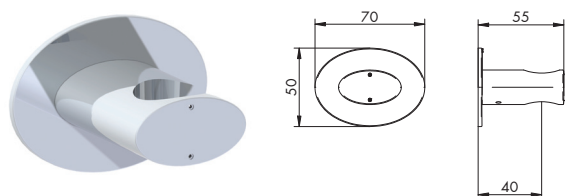

CROMATO	
01-834009	€

ALTRE FINITURE - GRUPPO 2	
XX-834009	€

GANCI
FISSI

805019

GANCIO INCASSO FISSO OVALE
BUILT-IN OVAL FIXED HOOK

> attacco da 1/2"

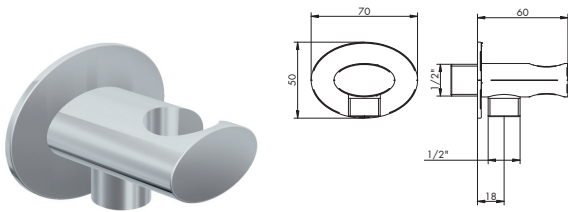

CROMATO		ALTRE FINITURE - GRUPPO 2	
01-805019	€	XX-805019	€

834006

GANCIO INCASSO FISSO OVALE C/SWAROVSKI
BUILT-IN OVAL FIXED HOOK WITH SWAROVSKI

> attacco da 1/2"

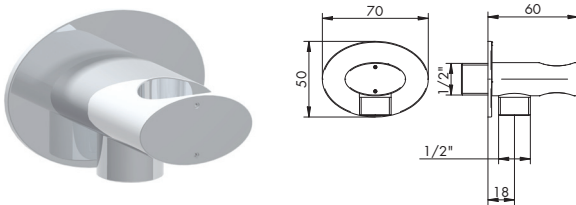

CROMATO		ALTRE FINITURE - GRUPPO 2	
01-834006	€	XX-834006	€



GANCI
FISSI

654044

GANCIO ESTERNO FISSO QUADRO
EXTERNAL SQUARE FIXED HOOK

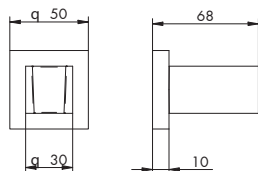

CROMATO
01-654044

€

ALTRE FINITURE - GRUPPO 2
XX-654044

€

334009

GANCIO ESTERNO FISSO QUADRO C/SWAROVSKI
EXTERNAL SQUARE FIXED HOOK WITH SWAROVSKI

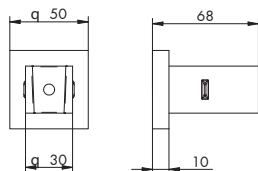

CROMATO
01-334009

€

ALTRE FINITURE - GRUPPO 2
XX-334009

€



GANCI
FISSI

094010

GANCIO INCASSO FISSO QUADRO
 SQUARE BUILT-IN FIXED HOOK

> attacco da 1/2"

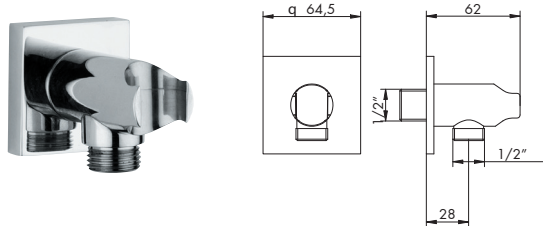

CROMATO		ALTRE FINITURE - GRUPPO 2	
01-094010	€	XX-094010	€

654043

GANCIO INCASSO FISSO QUADRO
 SQUARE BUILT-IN FIXED HOOK

> attacco da 1/2"

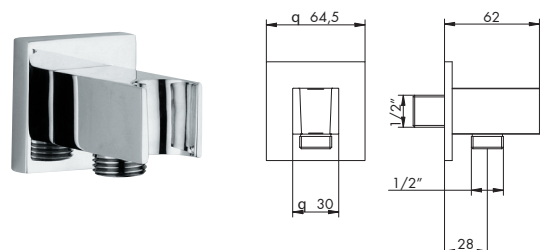

CROMATO		ALTRE FINITURE - GRUPPO 2	
01-654043	€	XX-654043	€

584031

GANCIO INCASSO FISSO
 SQUARE BUILT-IN FIXED

> attacco da 1/2"

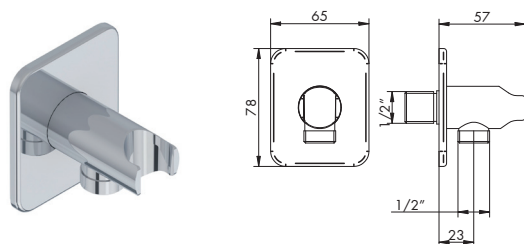

CROMATO		ALTRE FINITURE - GRUPPO 2	
01-584031	€	XX-584031	€



GANCI
 FISSI

334004

GANCIO INCASSO FISSO QUADRO C/SWAROVSKI
 SQUARE BUILT-IN FIXED HOOK WITH SWAROVSKI

> attacco da 1/2"

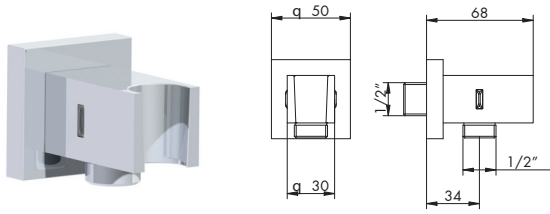

CROMATO
 01-334004

€

ALTRE FINITURE - GRUPPO 2
 XX-334004

€



GANCI
 FISSI

034124

GANCIO INCASSO FISSO

BUILT-IN FIXED HOOK

> attacco da 1/2"

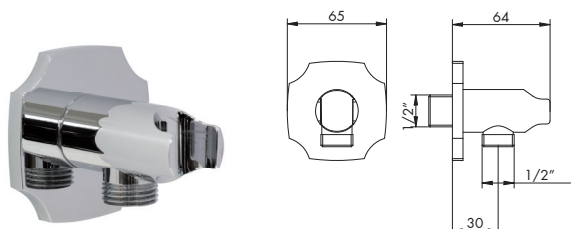

CROMATO		ALTRE FINITURE - GRUPPO 2	
01-034124	€	XX-034124	€



GANCI
FISSI



**GANCI
FISSI**

GANCI DUPLEX

EQB DESIGN

INDICE | INDEX

CONICO ESTERNO	pag.	218
CONICO INCASSO	pag.	219
TONDO ESTERNO	pag.	220
TONDO INCASSO	pag.	221
OVALE ESTERNO	pag.	222
QUADRO ESTERNO	pag.	223
QUADRO INCASSO	pag.	224
CLASSIC ESTERNO	pag.	225



GANCI
DUPLEX

865009

GANCIO ESTERNO DUPLEX
EXTERNAL MOVABLE HOOK

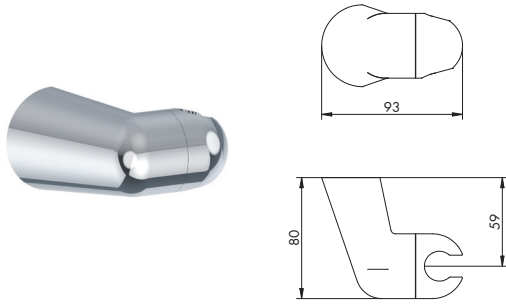

CROMATO	
01-865009	€

NON DISPONIBILE IN ALTRE
FINITURE
NOT AVAILABLE IN OTHER
FINISHES

035102

GANCIO ESTERNO DUPLEX
EXTERNAL MOVABLE HOOK

> supporto doccia snodato

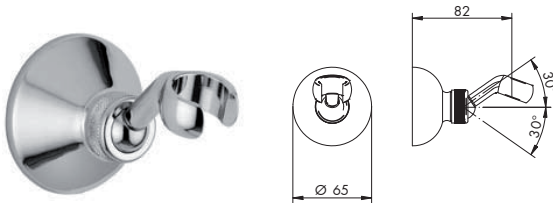

CROMATO	
01-014084	€

ALTRE FINITURE - GRUPPO 2	
XX-014084	€



GANCI
DUPLEX

035101

GANCIO INCASSO DUPLEX
BUILT-IN MOVABLE HOOK

> attacco da 1/2"

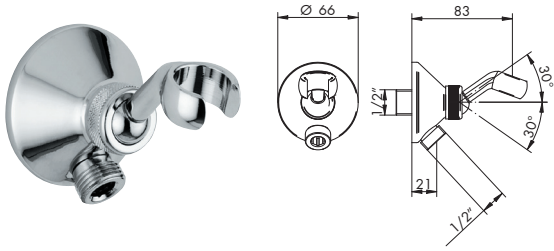

CROMATO	
01-035101	€

ALTRE FINITURE - GRUPPO 2	
XX-035101	€



GANCI
DUPLEX

445005

GANCIO ESTERNO DUPLEX
EXTERNAL MOVABLE HOOK

> supporto doccia snodato



CROMATO	
01-445005	€

ALTRE FINITURE - GRUPPO 2	
XX-445005	€

014081

GANCIO ESTERNO DUPLEX
EXTERNAL MOVABLE HOOK

> supporto doccia snodato

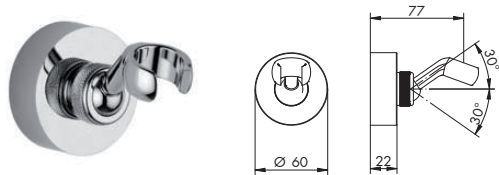

CROMATO	
01-014081	€

ALTRE FINITURE - GRUPPO 2	
XX-014081	€



GANCI
 DUPLEX

014080

GANCIO INCASSO DUPLEX
BUILT-IN MOVABLE HOOK

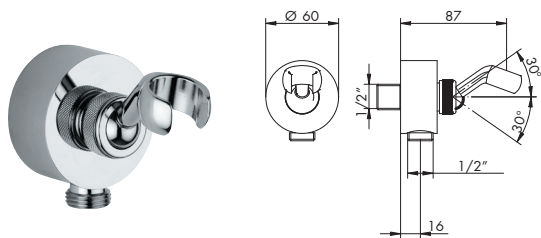

CROMATO		ALTRE FINITURE - GRUPPO 2	
01-014080	€	XX-014080	€



GANCI
DUPLEX

804019

GANCIO ESTERNO DUPLEX

EXTERNAL MOVABLE HOOK

> supporto doccia snodato

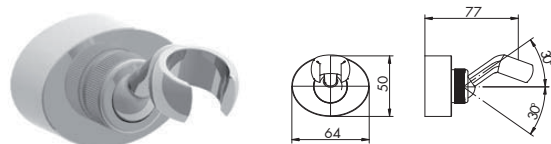

CROMATO

01-804019

€

ALTRE FINITURE - GRUPPO 2

XX-804019

€



GANCI
DUPLEX

655005

GANCIO ESTERNO DUPLEX
EXTERNAL MOVABLE HOOK

> supporto doccia snodato

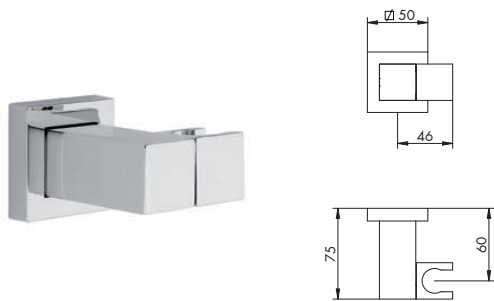

CROMATO
01-655005 €

ALTRE FINITURE - GRUPPO 2
XX-655005 €



GANCI
DUPLEX

094004

GANCIO INCASSO DUPLEX RETTANGOLARE
RECTANGULAR BUILT-IN MOVABLE HOOK

> attacco da 1/2"

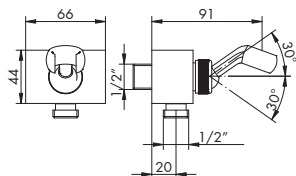

CROMATO	
01-094004	€

ALTRE FINITURE - GRUPPO 2	
XX-094004	€

655012

GANCIO INCASSO DUPLEX QUADRO
SQUARE BUILT-IN MOVABLE HOOK

> attacco da 1/2"

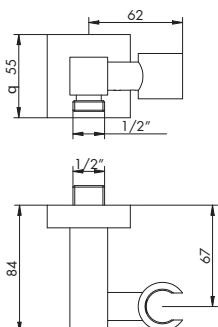

CROMATO	
01-655012	€

ALTRE FINITURE - GRUPPO 2	
XX-655012	€

334006

GANCIO INCASSO DUPLEX QUADRO C/SWAROVSKI
SQUARE BUILT-IN MOVABLE HOOK WITH SWAROVSKI

> attacco da 1/2"

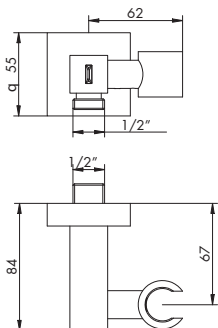
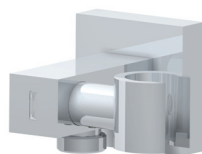

CROMATO	
01-334006	€

ALTRE FINITURE - GRUPPO 2	
XX-334006	€



144023

GANCIO ESTERNO DUPLEX
EXTERNAL MOVABLE HOOK

> supporto doccia snodato

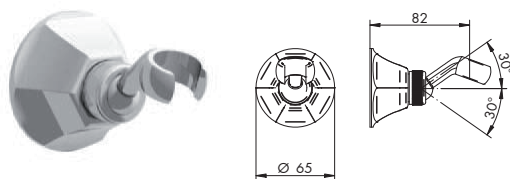
**CROMATO**

01-144023

€

ALTRE FINITURE - GRUPPO 2

XX-144023

€

GANCI
DUPLEX



GANCI
DUPLEX

INDICE | INDEX

TONDA	pag.	228/231
OVALE	pag.	232
QUADRA	pag.	233/234
CLASSIC	pag.	235/236



445004

DOCCEFFA CILINDRICA MONOGETTO ABS
ABS MONO JET CYLINDRICAL HANDSET

> attacco da 1/2"

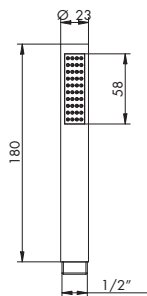

CROMATO	
01-445004	€

NON DISPONIBILE IN ALTRE
 FINITURE
 NOT AVAILABLE IN OTHER
 FINISHES

865008

DOCCEFFA MULTIFUNZIONE A 3 GETTI AERATI
CYLINDRICAL MULTIFUNCTION 3 AIRY JET HANDSET

> attacco da 1/2"

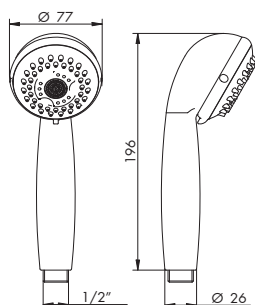

CROMATO	
01-865008	€

NON DISPONIBILE IN ALTRE
 FINITURE
 NOT AVAILABLE IN OTHER
 FINISHES

125091

DOCCEFFA MULTIFUNZIONE A 3 GETTI AERATI
CYLINDRICAL MULTIFUNCTION 3 AIRY JET HANDSET

- > corpo esterno in ABS
- > ugelli siliconici anticalcare
- > Ø100
- > attacco da 1/2"

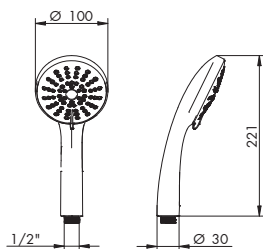

CROMATO	
01-125091	€

NON DISPONIBILE IN ALTRE
 FINITURE
 NOT AVAILABLE IN OTHER
 FINISHES

915001

DOCETTA MONOGETTO
MONO JET HANDSET

> attacco da 1/2"

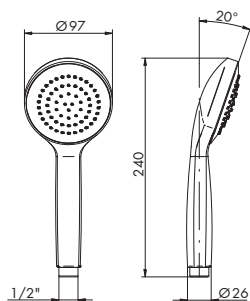

CROMATO	
01-915001	€

ALTRE FINITURE - GRUPPO 2	
XX-915001	€

445043

DOCETTA CILINDRICA MONOGETTO OTTONE
BRASS MONO JET CYLINDRICAL HANDSET

> attacco da 1/2"

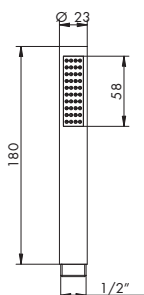

CROMATO	
01-445043	€

ALTRE FINITURE - GRUPPO 2	
XX-445043	€

125089

DOCETTA MULTIFUNZIONE 3 GETTI AREATI CILINDRICA
CYLINDRICAL MULTIFUNCTION 3 AIRY JET HAND SHOWER

- > corpo esterno in ABS
- > ugelli siliconici anticalcare
- > Ø100
- > attacco da 1/2"

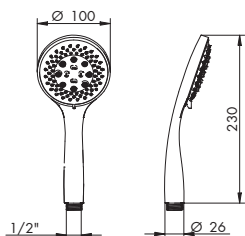

CROMATO	
01-125089	€

NON DISPONIBILE IN ALTRE FINITURE
NOT AVAILABLE IN OTHER FINISHES



DOCETTE

125090

DOCCE TTA MULTIFUNZIONE 3 GETTI AREATI STONDATA
ROUND MULTIFUNCTION 3 AIRY JET HAND SHOWER

- > corpo esterno in ABS
- > ugelli siliconici anticalcare
- > Ø105
- > attacco da 1/2"

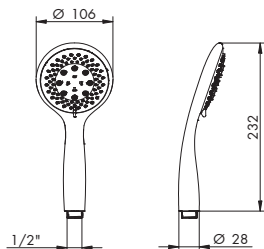

CROMATO	
01-125090	€

NON DISPONIBILE IN ALTRE FINITURE
NOT AVAILABLE IN OTHER FINISHES

030

DOCCE TTA MULTIGETTO
MULTI JET HANDSET

- > attacco da 1/2"

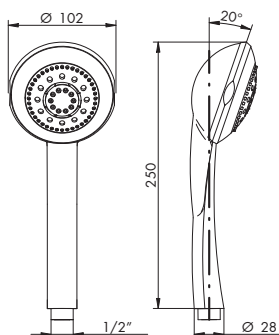

CROMATO	
01-030	€

ALTRE FINITURE - GRUPPO 2	
XX-030	€

055115

DOCCE TTA MULTIGETTO C/ANTICALCARE
MULTI JET LIMESCALE HANDSET

- > attacco da 1/2"

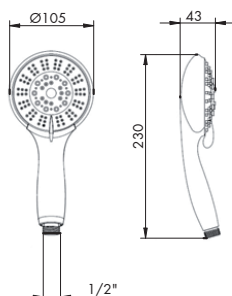

CROMATO	
01-055115	€

ALTRE FINITURE - GRUPPO 2	
XX-055115	€

634002

DOCETTA MONOGETTO BEL
COMPLETE "BEL" MONO JET HANDSET

> attacco da 1/2"

- > 01 inserti cromato
- > 66 inserti bianco opaco
- > 67 inserti nero opaco
- > XX inserti in finitura

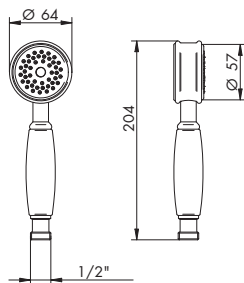
**CROMATO**

01-634002-01	cromato	€
01-634002-66	bianco op.	€
01-634002-67	nero op.	€

ALTRE FINITURE - GRUPPO 2

XX-634002-XX	finitura	€
XX-634002-66	bianco op.	€
XX-634002-67	nero op.	€



DOCETTE

805006

DOCETTA OVALE MONOGETTO ABS
 OVAL MONO JET CYLINDRICAL HANDSET

> attacco da 1/2"

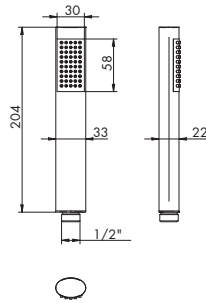

CROMATO	
01-805006	€

NON DISPONIBILE IN ALTRE
 FINITURE
 NOT AVAILABLE IN OTHER
 FINISHES



DOCETTE

755003

DOCETTA RETTANGOLARE MONOGETTO ABS
ABS MONO JET RECTANGULAR HANDSET

> attacco da 1/2"

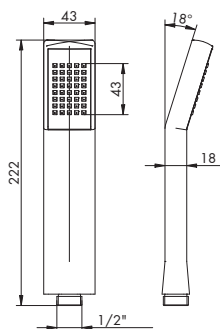

CROMATO	
01-755003	€

NON DISPONIBILE IN ALTRE
 FINITURE
 NOT AVAILABLE IN OTHER
 FINISHES

655018

DOCETTA QUADRA MONOGETTO ABS
ABS MONO JET SQUARE HANDSET

> attacco da 1/2"

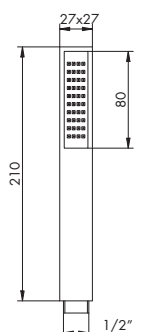

CROMATO	
01-655018	€

NON DISPONIBILE IN ALTRE
 FINITURE
 NOT AVAILABLE IN OTHER
 FINISHES

655197

DOCETTA QUADRA MONOGETTO OTTONE
BRASS MONO JET SQUARE HANDSET

> attacco da 1/2"

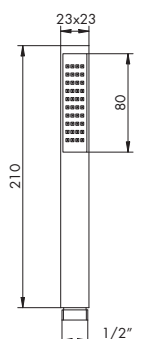

CROMATO	
01-655197	€

ALTRE FINITURE - GRUPPO 2	
XX-655197	€



DOCETTE

125094

DOCCIA MULTIFUNZIONE 2 GETTI QUADRA
SQUARE MULTIFUNCTION 2 AIRY JET HAND SHOWER

- > corpo esterno in ABS
- > ugelli siliconici anticalcare
- > 120 x 120
- > attacco da 1/2"

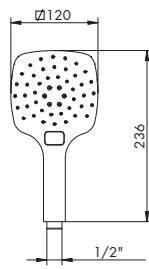

CROMATO	
01-125094	€

**NON DISPONIBILE IN ALTRE
 FINITURE**
**NOT AVAILABLE IN OTHER
 FINISHES**

145002

DOCCETTA MONOGETTO
MONO JET HANDSET

- > attacco da 1/2"

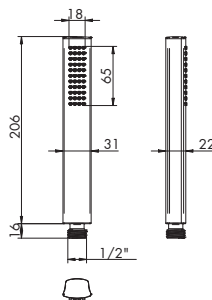

CROMATO	
01-145002	€

ALTRE FINITURE - GRUPPO 2	
XX-145002	€



DOCCE

034053

DOCETTA CLASSIC MONOGETTO CON MANICO LEGNO
CLASSIC MONO JET HANDSET WOODEN HANDLE

> attacco da 1/2"

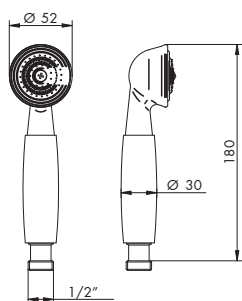

CROMATO	
01-034053	€

ALTRE FINITURE - GRUPPO 2	
XX-034053	€

035092

DOCETTA CLASSIC MONOGETTO CON MANICO BIANCO
CLASSIC MONO JET HANDSET WHITE HANDLE

> attacco da 1/2"

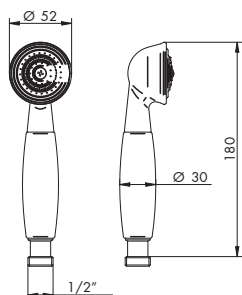

CROMATO	
01-035092	€

ALTRE FINITURE - GRUPPO 2	
XX-035092	€

074013

DOCETTA PHONE MONOGETTO C/MANICO LEGNO
PHONE SHOWER HANDSET WOOD HANDLE

> attacco da 1/2"

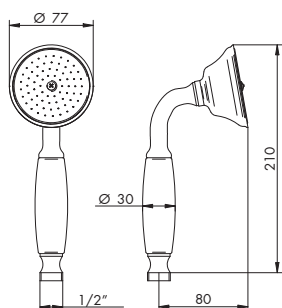

CROMATO	
01-074013	€

ALTRE FINITURE - GRUPPO 2	
XX-074013	€



DOCETTE

075004

DOCGETTA PHONE MONOGETTO C/MANICO BIANCO
PHONE SHOWER HANDSET WHITE HANDLE

> attacco da 1/2"

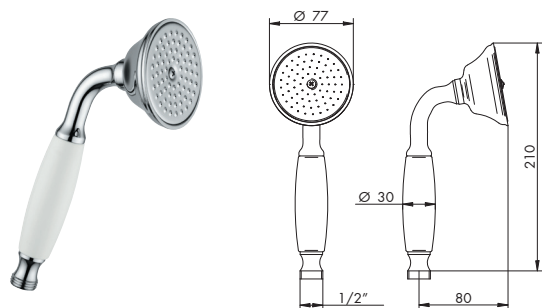

CROMATO
 01-075004 €

ALTRE FINITURE - GRUPPO 2
 XX-075004 €



DOCLETTE

574014

DOCGETTA MONOGETTO BR
COMPLETE "BR" MONO JET HANDSET

> attacco da 1/2"

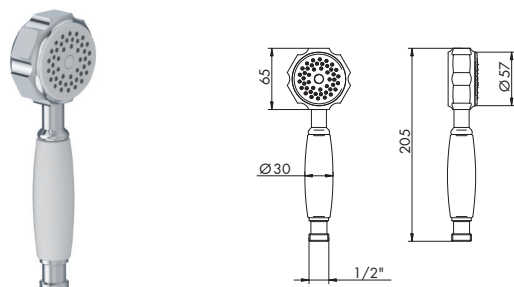

CROMATO
 01-574014 €

ALTRE FINITURE - GRUPPO 2
 XX-574014 €

INDICE | INDEX

CM 150	pag.	238
CM 200	pag.	239



655016

FLESSIBILE 1/2" F X 1/2" F CONICO L=150CM
 CONICAL FLEXIBLE 1/2" F X 1/2" F L=150CM



CROMATO		ALTRE FINITURE - GRUPPO 2	
01-655016	€	XX-655016	€

915003

FLESSIBILE 1/2" F CONICO X 1/2" F CONICO L=150 CM
 CONICAL FLEXIBLE 1/2" F X 1/2" F L=150CM

* realizzabili solo in finiture:
 01,03,04,05,06,07,12,13,19,28,30,33,34,35,66,67,68,69,71,72,75,B2,B3,B4

* available only:
 01,03,04,05,06,07,12,13,19,28,30,33,34,35,66,67,68,69,71,72,75,B2,B3,B4



CROMATO		ALTRE FINITURE - GRUPPO 2	
01-915003	€	XX-915003	€

655027

FLESSIBILE 1/2" F X 1/2" F CONICO L=200CM
 CONICAL FLEXIBLE 1/2" F X 1/2" F L=200 CM



CROMATO		ALTRE FINITURE - GRUPPO 2	
01-655027	€	XX-655027	€

915020

FLESSIBILE 1/2" F CONICO X 1/2" F CONICO L=200 CM
 CONICAL FLEXIBLE 1/2" F X 1/2" F L=200 CM

* realizzabili solo in finiture:
 01,03,04,05,06,07,12,13,19,28,30,33,34,35,66,67,68,69,71,72,75,B2,B3,B4

* available only:
 01,03,04,05,06,07,12,13,19,28,30,33,34,35,66,67,68,69,71,72,75,B2,B3,B4



CROMATO		ALTRE FINITURE - GRUPPO 2	
01-915020	€	XX-915020	€



FLESSIBILI