

0951

PORTABICCHIERE SINGOLO DA PARETE

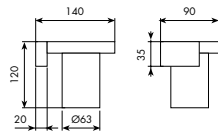

CROMATO

01-0951

€

ALTRE FINITURE

XX-0951

€

x M*

0952

PORTABICCHIERE SINGOLO D'APPOGGIO

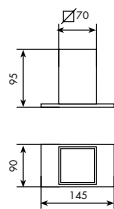

CROMATO

01-0952

€

ALTRE FINITURE

XX-0952

€

x M*

0953

PORTASAPONE SINGOLO DA PARETE

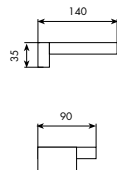

CROMATO

01-0953

€

ALTRE FINITURE

XX-0953

€

x M*

2553/1

DISPENSER DA PARETE

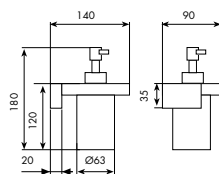

CROMATO

01-2553/1

€

ALTRE FINITURE

XX-2553/1

€

x M*

POMPETTA EROGATRICE
COMPLETA
COMPLETE SPRINKLER PUMP

483035

01- cromato / XX- finitura

0954

PORTASAPONE SINGOLO D' APPOGGIO

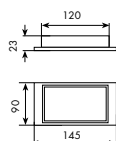

CROMATO

01-0954

€

ALTRE FINITURE

XX-0954

€

x M*

0954/1

PORTASAPONE SINGOLO D'APPOGGIO

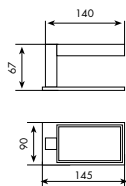

CROMATO

01-0954/1

€

ALTRE FINITURE

XX-0954/1

€

x M*

0970

DISPENSER D'APPOGGIO

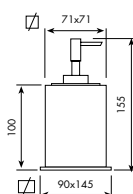

CROMATO

01-0970

€

ALTRE FINITURE

XX-0970

€

x M*

POMPETTA EROGATRICE
COMPLETA
COMPLETE SPRINKLER PUMP

483035

01- cromato / XX- finitura

0955

PORTABICCHIERE C/PORTASAPONE DA PARETE

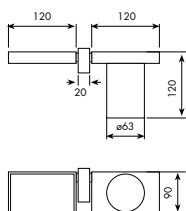

CROMATO

01-0955

€

ALTRE FINITURE

XX-0955

€

x M*

0956

PORTABICCHIERE C/PORTASAPONE D'APPOGGIO

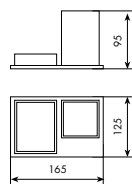

CROMATO

01-0956

€

ALTRE FINITURE

XX-0956

€

x M*

0957

PORTASAPONE DOPPIO DA PARETE

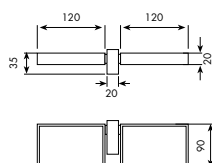

CROMATO

01-0957

€

ALTRE FINITURE

XX-0957

€

x M*

0958

PORTASAPONE DOPPIO D'APPOGGIO



CROMATO		ALTRE FINITURE	
01-0958	€	XX-0958	€ x M*

0959 | THEO

PIANTANA PORTASALVIETTE

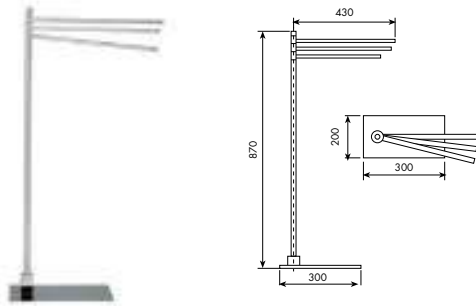

CROMATO		ALTRE FINITURE	
01-0959	€	XX-0959	€ x M*

2559 | T-LUX

PIANTANA PORTASALVIETTE

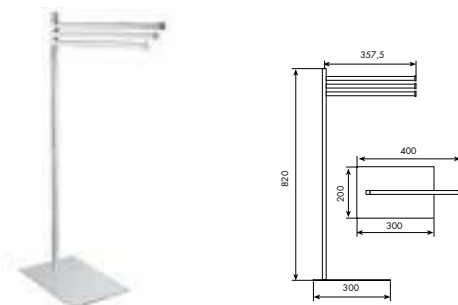

CROMATO		ALTRE FINITURE	
01-2559	€	XX-2559	€ x M*

0959/2 | THEO

PIANTANA CON DISPENSER, PORTASALVIETTE, PORTAROTOLO E PORTASCIOPINO

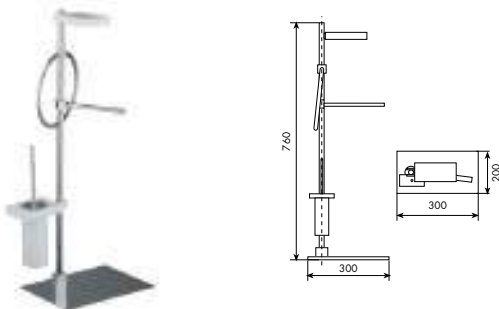

CROMATO		ALTRE FINITURE	
01-0959/2	€	XX-0959/2	€ x M*



2559/2 | T-LUX

PIANTANA CON DISPENSER, PORTASALVIETTE, PORTAROTOLO E PORTASCIOPINO

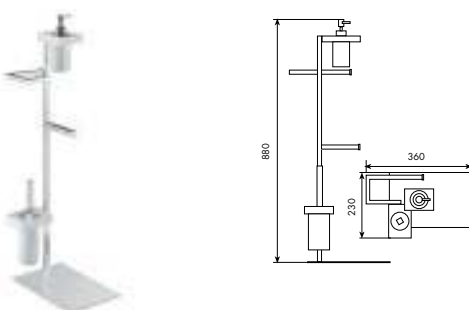

CROMATO		ALTRE FINITURE	
01-2559/2	€	XX-2559/2	€ x M*

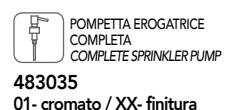

W-6 FOR THE PRICES OF THE INDICATED SPARE PARTS CODE look at the page W-11

XX = FINISHING CODE REQUIRED: to identify the correct code look at the page W-3
M* = MULTIPLIER: to calculate the price of the other finishes, look at the table on page W-3

0960 | THEO

PORTASALVIETTE ANELLO

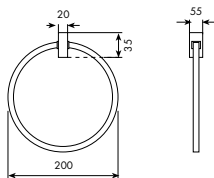

CROMATO

01-0960

€

ALTRE FINITURE

XX-0960

€

x M*

2560 | T-LUX

PORTASALVIETTE A GANCIO

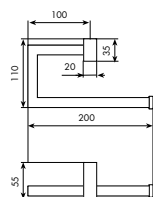

CROMATO

01-2560

€

ALTRE FINITURE

XX-2560

€

x M*

0962/30 | THEO

PORTASALVIETTE DA 30 CM

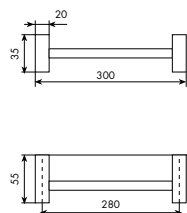

CROMATO

01-0962/30

€

ALTRE FINITURE

XX-0962/30

€

x M*

2562/30 | T-LUX

PORTASALVIETTE DA 30 CM

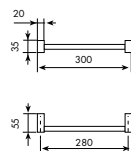

CROMATO

01-2562/30

€

ALTRE FINITURE

XX-2562/30

€

x M*

0962/45 | THEO

PORTASALVIETTE DA 45 CM

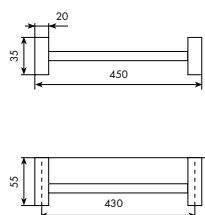

CROMATO

01-0962/45

€

ALTRE FINITURE

XX-0962/45

€

x M*

2562/45 | T-LUX

PORTASALVIETTE DA 45 CM



CROMATO	
01-2562/45	€

ALTRE FINITURE	
XX-2562/45	€ x M*

0962/60 | THEO

PORTASALVIETTE DA 60 CM

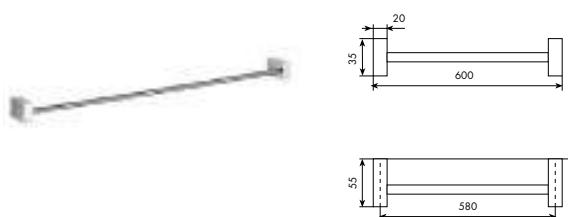

CROMATO	
01-0962/60	€

ALTRE FINITURE	
XX-0962/60	€ x M*

2562/60 | T-LUX

PORTASALVIETTE DA 60 CM



CROMATO	
01-2562/60	€

ALTRE FINITURE	
XX-2562/60	€ x M*

0963 | THEO

APPENDIABITO

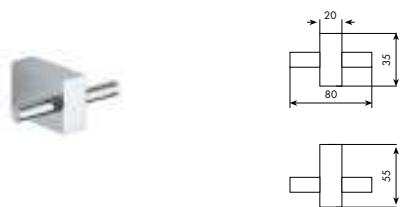

CROMATO	
01-0963	€

ALTRE FINITURE	
XX-0963	€ x M*

2563 | T-LUX

APPENDIABITO

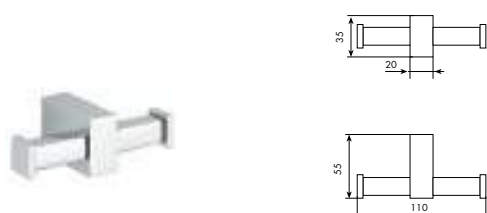

CROMATO	
01-2563	€

ALTRE FINITURE	
XX-2563	€ x M*

0964 | THEO

PORTAROTOLO

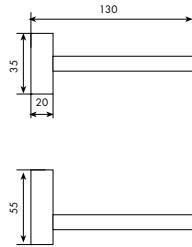

CROMATO

01-0964

€

ALTRE FINITURE

XX-0964

€

x M*

2564 | T-LUX

PORTAROTOLO

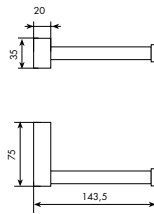

CROMATO

01-2564

€

ALTRE FINITURE

XX-2564

€

x M*

0965 | THEO

PORTASCOPINO DA PARETE

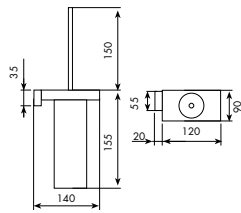

CROMATO

01-0965

€

ALTRE FINITURE

XX-0965

€

x M*



093018

2565 | T-LUX

PORTASCOPINO DA PARETE

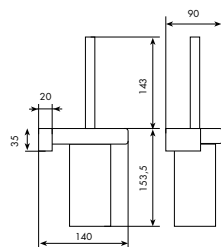

CROMATO

01-2565

€

ALTRE FINITURE

XX-2565

€

x M*



093018

0966 | THEO

PORTASCOPINO D'APPOGGIO

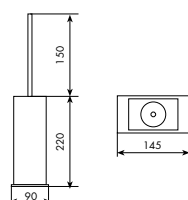

CROMATO

01-0966

€

ALTRE FINITURE

XX-0966

€

x M*



093018

2566 | T-LUX

PORTASCPINO D'APPOGGIO

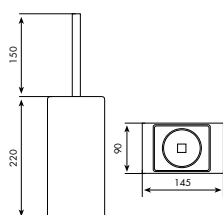

CROMATO

01-2566

€

ALTRE FINITURE

XX-2566

€

x M*



093018

0968

APPLIQUE

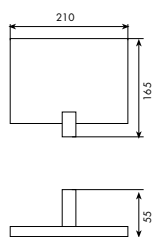

CROMATO

01-0968

€

ALTRE FINITURE

XX-0968

€

x M*

0969

MENSOLA CRISTALLO

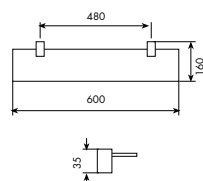

CROMATO

01-0969

€

ALTRE FINITURE

XX-0969

€

x M*



RICAMBI



POMPETTE EROGATRICI COMPLETE COMPLETE SPRINKLER PUMPS

01-183003	cromato	XX-183003	altre finiture
01-483035	cromato	XX-483035	altre finiture
01-833002	cromato	XX-833002	altre finiture



RICCI HEDGEHOGS

033036	senza finitura
073025	senza finitura
093018	senza finitura
613054	senza finitura
803011	senza finitura



BICCHIERI GLASSES

093003	senza finitura
803007	senza finitura



PORTASAPONI SOAP DISHES

073020	senza finitura
093006	senza finitura
803002	senza finitura



VETRI GLASSES

616002	senza finitura
--------	----------------



CRISTALLI CRYSTALS

033041	senza finitura
073029	senza finitura
093020	senza finitura
616001	senza finitura
803016	senza finitura

ELENCO COMPLETO DISPONIBILE ON LINE: WWW.BELLOSTARUBINETTERIE.COM/ONLINE/RICAMBI.PDF
LISTED COMPLETED AVAILABLE ON LINE: WWW.BELLOSTARUBINETTERIE.COM/ONLINE/RICAMBI.PDF

PER IL CALCOLO DEL PREZZO DELLE FINITURE DIVERSE DAL CROMATO VEDI PAG. W-3
TO CALCULATE THE PRICE FOR DIFFERENT COLORS LOOK AT THE PAGE W-3