

New Products



 agape

Index / Indice

Introduction / Introduzione → pag 03

Washbasins / Lavabi

Lariana → pag 04 / Raso → pag 06 / Undici → pag 10 /
Undici InOX → pag 12

Mirrors / Specchi

Narciso → pag 16 / Seppia → pag 20 / Vitruvio → pag 21

Taps / Rubinetti

Limón → pag 22 / Memory Mix → pag 28

Agape New Products

With the new 2021 products, Agape deepens its exploration into the languages of balance and solidity. A balance, never rigid, that tends toward gentle and welcoming forms. A vision of the bathroom as an architecture of the senses and a space for wellness. Good design is the unseen score of this symphony. Materials, functions and emotions are fine-tuned in an ever-changing ensemble, following a process of lateral thinking that results in timeless works of design. Washbasins, faucets, furniture, bathtubs, lights and accessories designed to interact with each other in an open, natural dialogue.

Designed by Benedini Associati, the new range of **Evo 21 system** was inspired by the simplicity of the trilith - the original architectural archetype. The system is designed for ultimate simplicity in configuration and installation, together with true compositional and aesthetic flexibility.

Starting from Evo 21, Giampaolo Benedini designs the new **Raso, Undici and Undici Inox washbasins** - all perfectly sized to work together with the new system. Patricia Urquiola adds new options to the wide range of **Lariana washbasins**.

For Agape, balance also means an exploration of geometry. The **Vitruvio mirrors** by García Cumini offer an elegant synthesis of circle and square. Benedini Associati recalls the lines of the superellipse introducing the **Seppia mirror**, and adds new lateral options to the long-seller **Narciso mirror** range.

Patricia Urquiola's design for the **Limón tapware** grafts two geometric elements into a surprising new object.

Agape further develops the already rich and varied world of tapware with **Memory Mix**, designed by Benedini Associati. This collection, debuting a new brushed-nickel finish, introduces new features to the classic Memory line while keeping a clear continuity of form.

After an intense year, the 2021 additions are transversal to the Agape catalogue, in continuity with the spirit of the product range as a whole, never losing sight of the design of the bathroom architecture in its entirety.

Con i nuovi prodotti 2021, Agape esplora ancora più a fondo il linguaggio dell'equilibrio e della solidità. Un equilibrio mai rigido, che sceglie forme gentili e accoglienti, in una visione dell'ambiente bagno come architettura dei sensi e luogo di benessere. Partitura invisibile, come sempre, il buon progetto. Materiali, funzioni, emozioni calibrate in una sintesi sempre diversa, secondo un pensiero laterale e coerente che si traduce in pezzi senza tempo. Lavabi, rubinetterie, mobili, vasche, luci, accessori studiati per interagire fra loro, in un dialogo aperto e naturale.

Il nuovo **programma Evo 21**, design Benedini Associati, si ispira all'essenzialità del trilite - archetipo architettonico per eccellenza. Il sistema è studiato per dare massima semplicità di configurazione e installazione, insieme a una grande flessibilità non solo compositiva ma anche estetica.

Attorno a Evo 21 Giampaolo Benedini progetta i nuovi **lavabi Raso, Undici e Undici Inox**, tutti perfettamente funzionali nelle dimensioni alla struttura del sistema. Il catalogo si arricchisce di nuove opzioni di forma anche per la famiglia di **lavabi Lariana**, disegnata da Patricia Urquiola.

Equilibrio per Agape è anche ricerca sulla geometria. Gli **specchi Vitruvio** di García Cumini offrono una sintesi elegante fra cerchio e quadrato. Benedini Associati riprende la geometria libera e smussata della superellipse introducendo lo **specchio Seppia**, e aggiunge nuove opzioni laterali per lo **specchio Narciso**.

Patricia Urquiola progetta la **rubinetteria Limón** unendo due elementi geometrici in un innesto sorprendente.

Memory Mix, design Benedini Associati, introduce, in un'evidente continuità formale, nuove funzioni alla famiglia Memory insieme alla nuova finitura nichel spazzolato.

Dopo un anno intenso, per il 2021 Agape presenta novità trasversali, in continuità con lo spirito del catalogo, senza mai perdere di vista il progetto dell'architettura del bagno nel suo complesso.



Evo 21, Benedini Associati – programme / programma
Undici, Benedini Associati – washbasin / lavabo → 10



Memory Mix, Benedini Associati – taps / rubinetteria → 28



Limón, Patricia Urquiola – taps / rubinetteria → 22



Narciso, Benedini Associati – mirror / specchio → 16



Seppia, Benedini Associati – mirror / specchio → 18



Vitruvio, García Cumini – mirror / specchio → 20



Raso, Benedini Associati – washbasin / lavabo → 06

Lariana

Over countertop washbasin / Lavabo da appoggio

Round and oval sinks are joined by this rectangular model, for countertop mounting. A natural complement to a product family that alternates fluid lines and geometric shapes in a harmonious whole. This rectangular version can also be paired with the Rigo system for a new set of possibilities. Available either in white or two colours with light grey, dark grey or Pine green exterior, in white Carrara, grey Carnic, black Marquina, green Alpi, dark Emperador and Petit Granit marble.

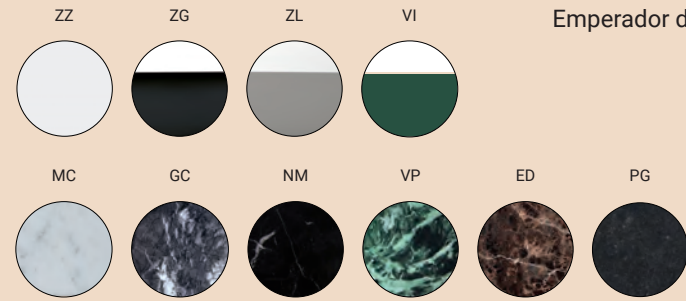

Accanto al lavabo tondo e ovale, la nuova forma rettangolare in appoggio. Un completamento naturale di questa famiglia di prodotti che alterna armoniosamente linee fluide e geometrie rigorose. La versione rettangolare apre anche nuove possibili configurazioni in abbinamento al sistema Rigo. Disponibile nelle finiture bianco o bicolore con esterno grigio chiaro, grigio scuro o verde pino, oppure in marmo bianco di Carrara, grigio Carnico, marmo nero Marquina, verde Alpi, Petit Granit e Emperador dark.

ACER1075_

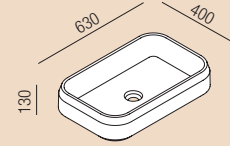

design Patricia Urquiola, 2021

ACER1075_

ACER1073_

ACER1074_

Lariana

Over countertop washbasin / Lavabo da appoggio

Lariana – washbasin / lavabo
Limón – taps / rubinetteria



Raso

Over countertop washbasin / Lavabo da appoggio

Almost twenty years from the release of its first version, the Raso washbasin debuts in the newfangled over-countertop version for every Agape container system. The new washbasin evolves its lines, details and dimensions while remaining faithful to the clean geometries that made the original version so iconic and versatile at the same time. Raso over-countertop is available in one size in thermoformed acrylic Solid surface or in marble, in the following finishes: white Carrara, grey Carnic, black Marquina, green Alpi, Emperador dark and Petit Granit.

A quasi vent'anni dal lancio della prima versione, il lavabo Raso debutta nell'inedita versione da appoggio da collocare sui piani dei diversi programmi Agape. Il nuovo lavabo si raffina nelle sue linee e si aggiorna nei dettagli e nelle dimensioni in sintonia con il rigore geometrico che lo ha reso allo stesso tempo iconico e molto versatile nei suoi abbinamenti. La versione in appoggio è disponibile in una sola dimensione nelle versioni in Solid surface termoformato a base acrilica oppure in marmo, in tutte le finiture Agape a catalogo: bianco di Carrara, grigio Carnico, nero Marquina, verde Alpi, Emperador dark e Petit Granit.

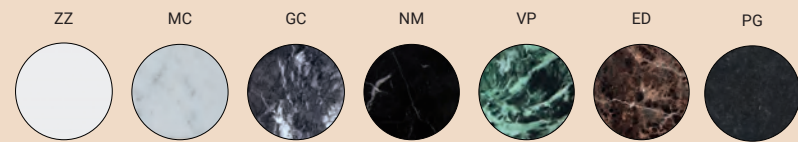
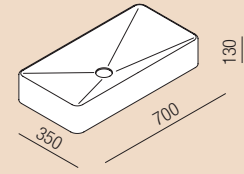
ACER0385_

design Benedini Associati, 2021

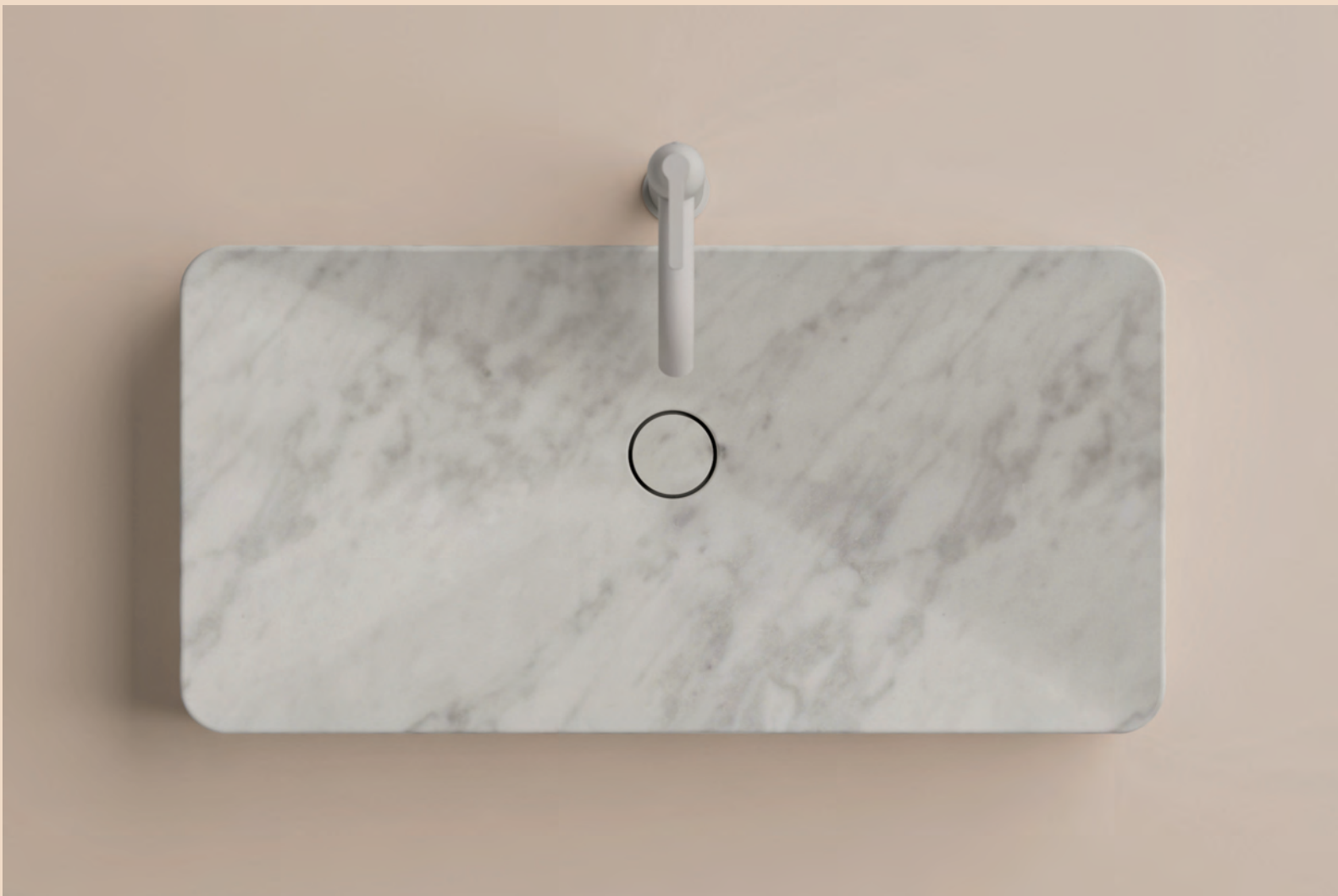

Raso

Over countertop washbasin / Lavabo da appoggio

Raso – washbasin / lavabo
Memory Mix – taps / rubinetteria
Evo 21 – programme / programma

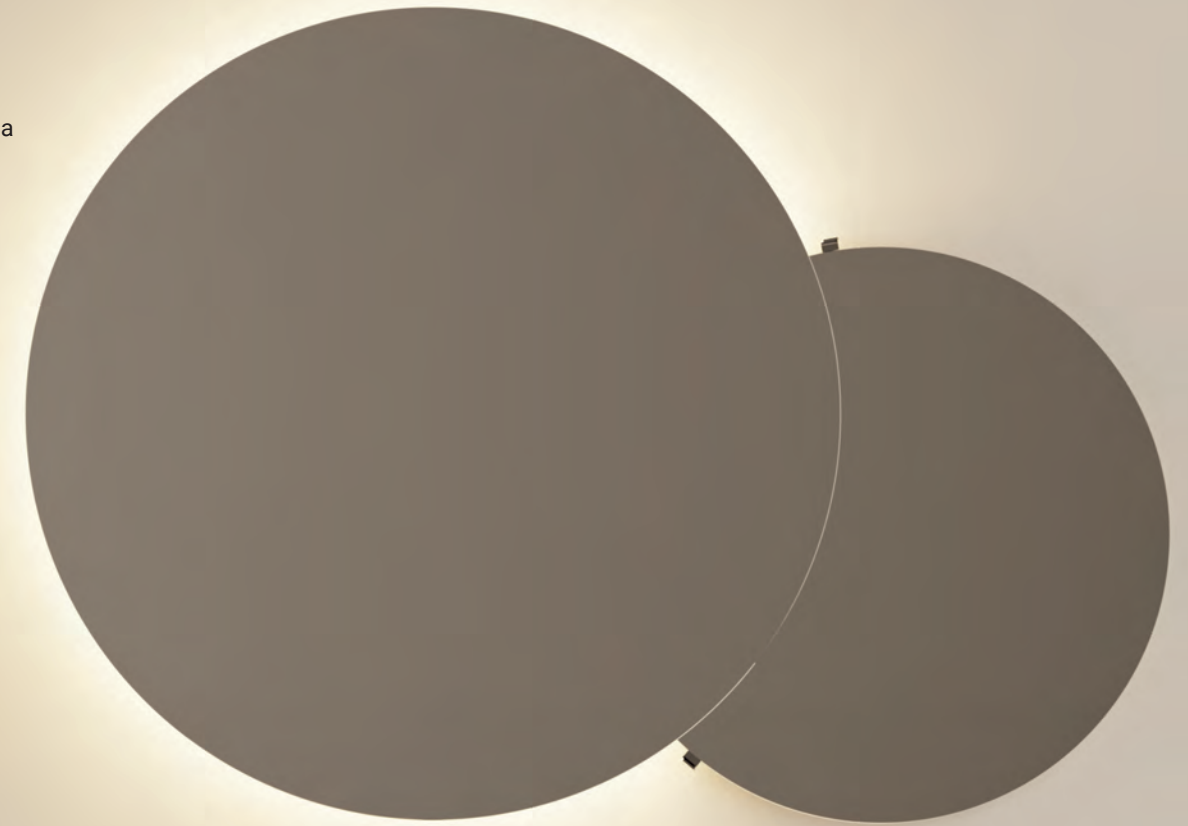

Raso

Integrated washbasin / Lavabo integrato

Together with the release of the new Evo 21 system, the Raso integrated washbasin, a long-seller in the Agape catalogue, also gets updated in its dimensions, details and materials. The new version remains faithful to the iconic geometries of Giampaolo Benedini's original design from 2003 and can be integrated in the new 12 mm Evo 21 Solid surface and the 6 cm thick Flat XL countertops. When used with the Flat XL programme, double-basin configurations are also available.

In occasione del lancio del sistema Evo 21, il lavabo Raso integrato, long seller del catalogo Agape, si aggiorna nei materiali, nei dettagli e nelle dimensioni. La nuova versione rimane fedele al rigore iconico del progetto originale di Giampaolo Benedini del 2003 e può essere inserito sui piani Evo 21 in Solid surface da 12 mm e sui piani Flat XL da 6 cm. Sui piani Flat XL è possibile anche in configurazione con doppio lavabo.

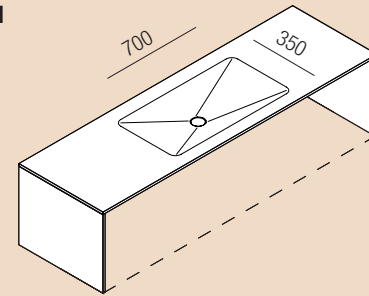
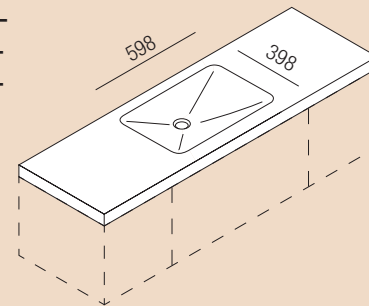
AE21PA185I**AXMRAS1Z_**
AXMRAS2Z_
AXNRAS2Z_
AXNRAS1Z_

design Benedini Associati, 2002 - 2021

EX (Flat XL) SS (Evo 21)

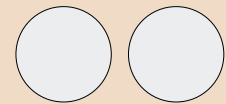
Raso – washbasin / lavabo
Memory Mix – taps / rubinetteria
Evo 21 – programme / programma**Raso**

Evo 21 integrated washbasin / Lavabo integrato nel piano Evo 21

Raso – washbasin / lavabo
Memory Mix – taps / rubinetteria
Evo 21 – programme / programma

Undici

Over countertop washbasins / Lavabi da appoggio

Undici washbasins, the name, italian for "eleven" comes from the characteristic that remains unchanged in the different versions: the height of 11 cm.

Made of white Solid surface with thermoforming processing, they are available in three shapes: round, oval or rectangular; they can be placed on all Agape tops or under the Evo 21 tops of the same material, becoming integrated elements on the top itself.

Lavabi Undici, il nome nasce dalla caratteristica che resta invariata nelle diverse versioni: l'altezza di cm 11. Realizzati in Solid surface bianco con lavorazione in termoformatura, sono disponibili in tre forme: tondo, ovale o rettangolare; possono essere posizionati in appoggio su tutti i piani Agape o integrati nei piani Evo 21 nel medesimo materiale diventando elementi integrati al piano stesso.

ACER0381

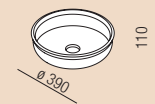

ACER0384

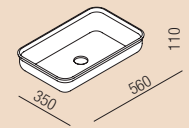

ACER0386

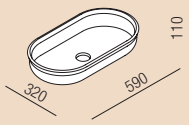

design Benedini Associati, 2021

ZZ

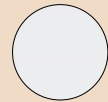

Undici

Over countertop washbasins / Lavabi da appoggio

Undici – washbasin / lavabo
Memory Mix – taps / rubinetteria
Seppia – mirror / specchio
Evo 21 – programme / programma



Undici Inox

Over countertop washbasin / Lavabo da appoggio

The Undici Inox washbasin comes from the Undici family of the same name, it is made of AISI 304 steel by turning from 3 mm slabs. Its pure shape allows to maintain the same geometry for the countertop and recessed version (the recessed version is available only for Evo 21 marble tops of 20 mm). Three finishes available: brushed stainless steel, brushed natural brass and brushed burnished.

Il lavabo Undici Inox nasce dall'omonima famiglia Undici, viene realizzato in acciaio AISI 304 per tornitura da lastre di mm 3. La sua forma pura consente di mantenere la stessa geometria per la versione da appoggio e ad incasso (la versione ad incasso è disponibile solo per piani Evo 21 in marmo da 20 mm). Tre le finiture disponibili: inox spazzolato, ottone naturale spazzolato e brunito spazzolato.

ACER0380

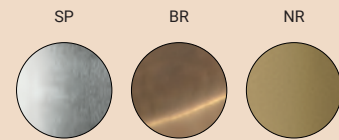
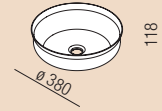

design Benedini Associati, 2021



Undici Inox

Over countertop washbasin / Lavabi da appoggio

Undici Inox – washbasin / lavabo
Memory Mix – taps / rubinetteria
Bucatini – mirror / specchio
Evo 21 – programme / programma

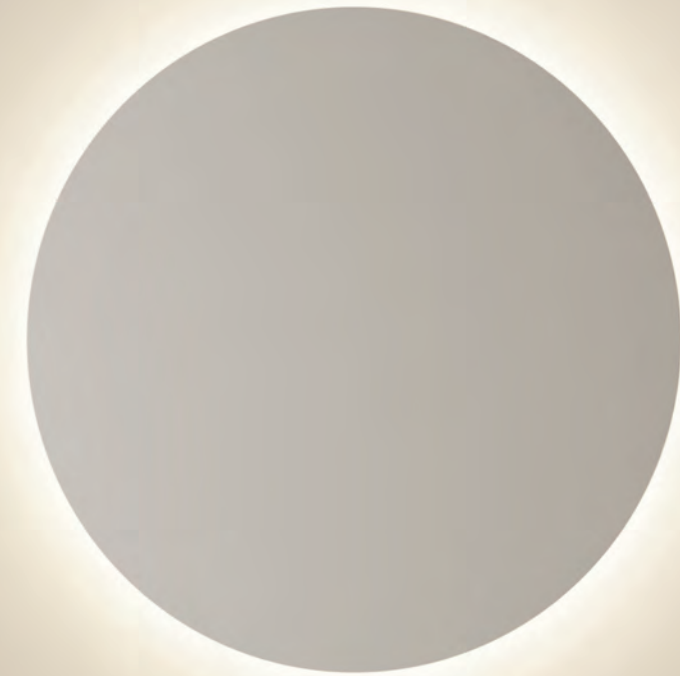

Undici, Undici Inox

Evo 21 integrated washbasins / Lavabi integrati nel piano Evo 21

AE21PA181I_SS
AE21PA281I_SS

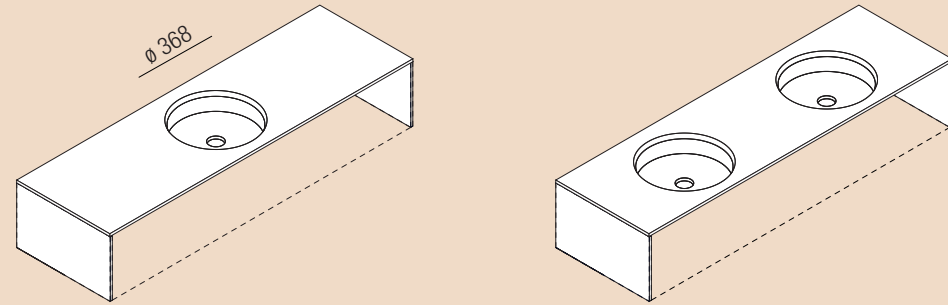

AE21PA184I_SS
AE21PA284I_SS

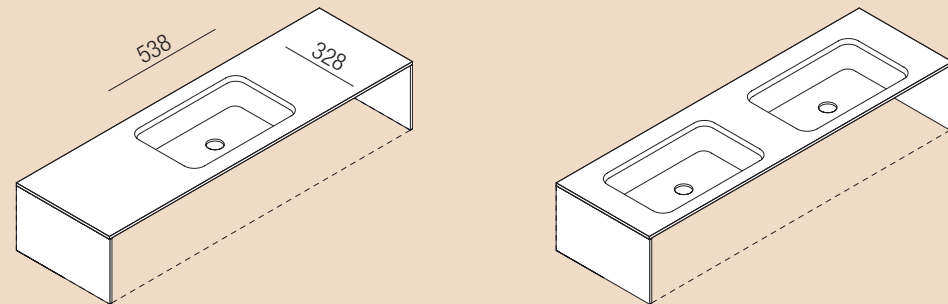

AE21PA186I_SS
AE21PA286I_SS

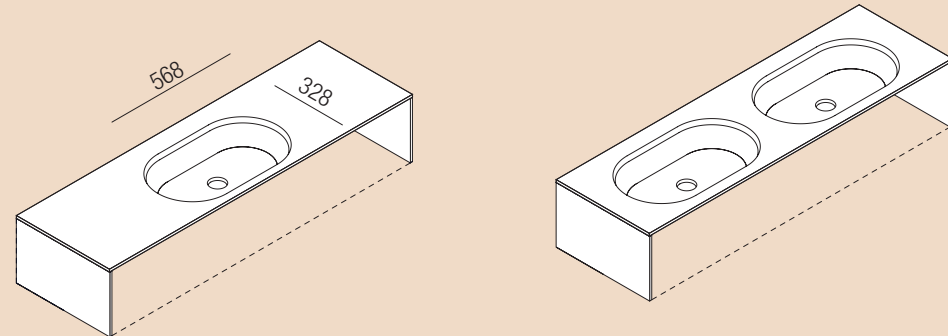

AE21PD1_
AE21PD2_

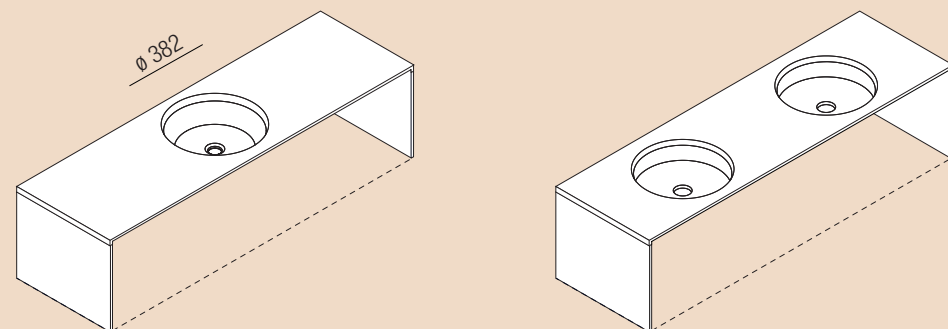

Undici, Undici Inox

Evo 21 integrated washbasins / Lavabi integrati nel piano Evo 21

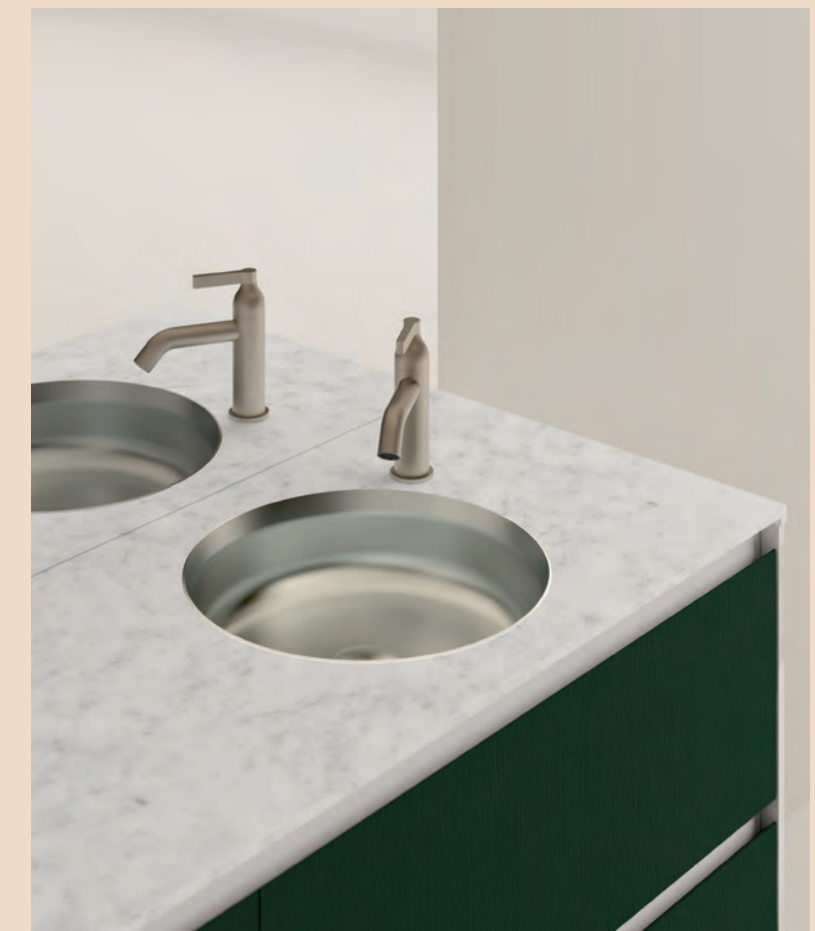

Narciso

Mirror / Specchio

Dedicated to those who want to take care of themselves in more than one way, Narciso is a mirror split into one, large, central and two, double-sided, pivoting side panels, supported by exposed, chromed brass hinges. The simplicity and expressive impact of the Narciso mirror are further emphasized by the backlighting system that gives it extra prominence on the wall, creating a play of reflections, light and shadows.

Dedicato a chi vuole prendersi cura di sé da ogni punto di vista, Narciso è uno specchio suddiviso in un grande elemento centrale e in due elementi laterali bifacciali orientabili, sostenuti da cerniere in ottone cromato a vista. L'essenzialità e la forza espressiva dello specchio Narciso vengono messe ancora più in evidenza dal sistema di retroilluminazione che lo fa spiccare sulla parete, creando giochi di riflessi, luci ed ombre.

The item is developed in several variants, the codes relating to the multiple dimensions are available on the price list /

L'articolo si sviluppa in più varianti, i codici relativi alle molteplici dimensioni sono disponibili sul listino

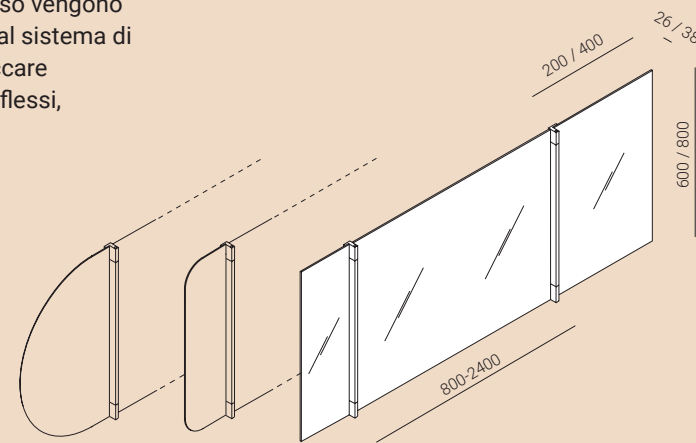

design Benedini Associati, 2003

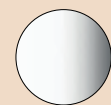

Narciso

Mirror / Specchio

Narciso H cm 80 – mirror / specchio
 Ell – washbasin countertop / piano lavabo
 Memory – taps / rubinetteria
 Lato – storage units / contenitori
 Spai – mirror / specchio



Narciso

Mirror / Specchio

Narciso H cm 80 – mirror / specchio
Memory Mix – taps / rubinetteria

**Narciso**

Mirror / Specchio

L – min 800 mm / max 2400 mm
H – 600 mm / 800 mm
S – 26 mm, without light / senza luce
S – 38 mm, with light / con luce

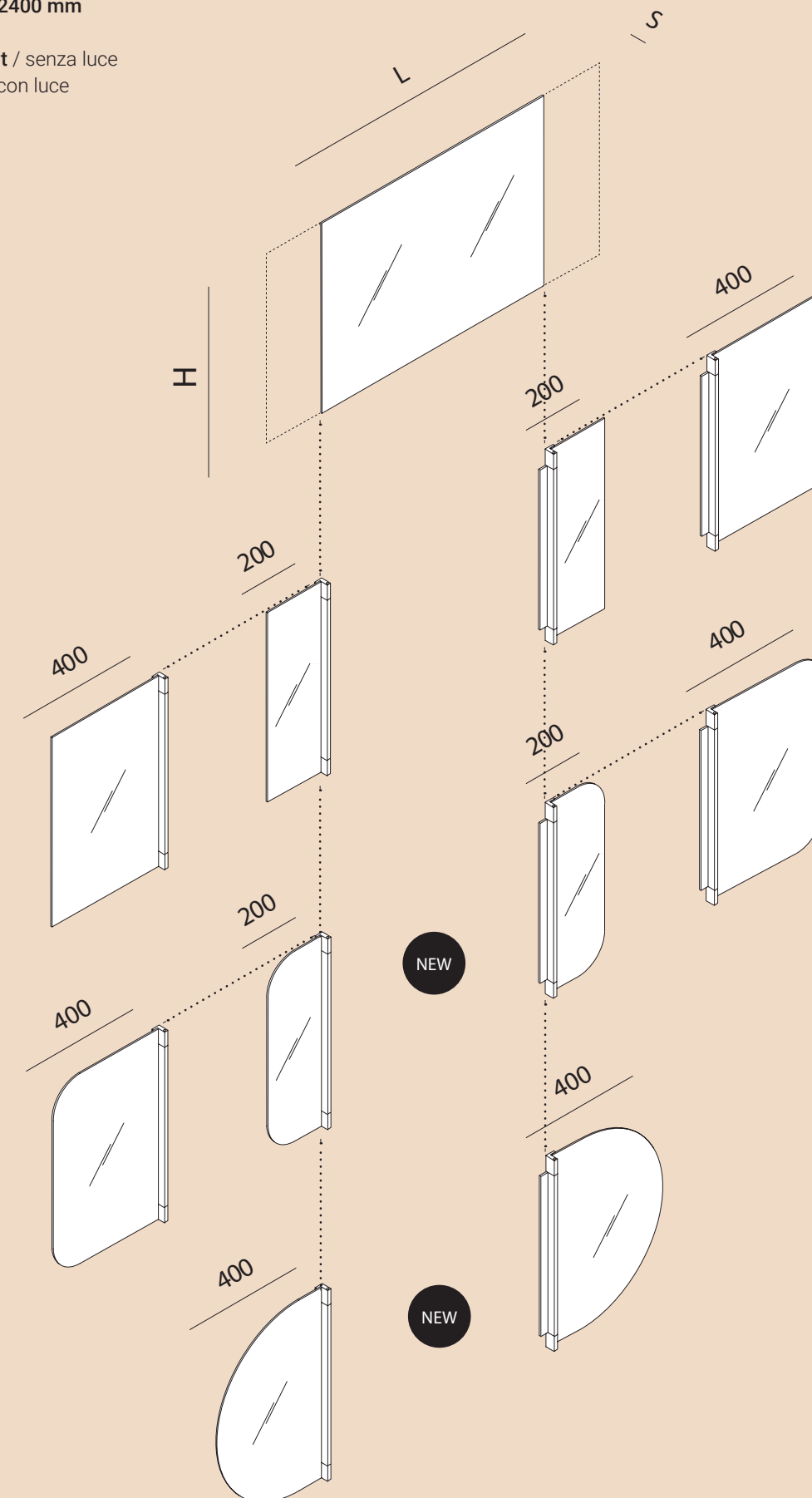

Seppia

Mirror / Specchio

The rounded corners of this design recall the mathematical concept of the superellipse. Halfway between a rectangle and an oval, this mirror by Benedini Associati echoes a shape commonly seen in furniture and car design of the 1960s and 70s, bringing its elegance back to center stage. Seppia's free and ineffable lines avoid harsh geometrical angles, in harmony with the welcoming atmosphere offered by Agape's bathroom design. The mirror can be back-lit with LED lighting and can be positioned horizontally or vertically according to the needs of the space.

Con i suoi angoli smussati, Seppia rimanda al concetto matematico di superellisse. A metà strada fra rettangolo e ovale, lo specchio progettato da Benedini Associati cita una forma che possiamo ritrovare negli arredi e nel car design degli anni '60 e '70 del '900 e ne riprende la purezza. La geometria libera e non definibile in modo univoco di Seppia evita l'eccessivo rigore, in sintonia con l'atmosfera accogliente dell'ambiente bagno di Agape. Lo specchio può essere retroilluminato con luce a LED ed è posizionabile in orizzontale o in verticale, a seconda delle tipologie di spazio.

ASPE0370
ASPE037V

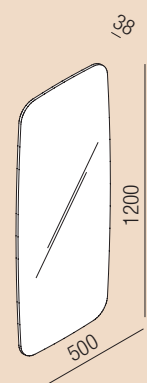

ASPE037L

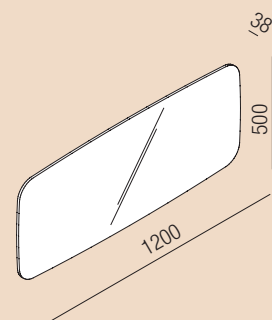

design Benedini Associati, 2021



agape

Vitruvio

Mirror / Specchio

A circle inscribed in a square. García Cumini's new collection of mirrors designed for Agape reinterprets classical style through a contemporary understanding of proportion and beauty. Like in theatre mirrors, an LED light surrounds the reflective surface, creating a clean line that illuminates without casting shadows. Vitruvio is available in three sizes - 60, 80 and 120 cm. They can be freely mix-and-matched, and are perfect for any type of space. A modular concept, suited to many varied and "reflective" compositions.

Un cerchio inscritto in un quadrato. La nuova collezione di specchi progettata da García Cumini per Agape guarda alla classicità in una visione contemporanea della proporzione e della bellezza. Come negli specchi teatrali una luce LED circonda la superficie riflettente e diventa una linea purissima capace di illuminare senza creare ombre. Vitruvio è disponibile in tre dimensioni, da 60, 80 e 120 cm, liberamente combinabili fra loro e adatte a tutti gli spazi. Una concezione modulare aperta a molteplici composizioni di sequenze specchianti.

ASPEV66LE

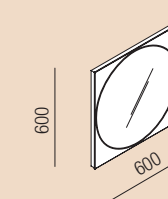

ASPEV1212LE

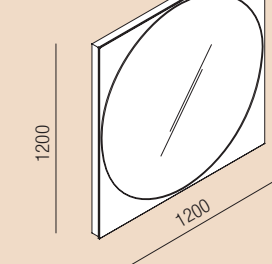

ASPEV88LE

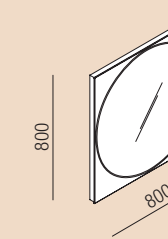

design García Cumini, 2021



agape

Limón

Taps / Rubinetti

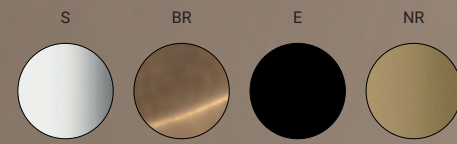

Fresh geometries: Agape presents the new Limón taps by Patricia Urquiola. Meeting and mating with its own circular section, just like in the age-old concept of agricultural grafting, has transformed the seemingly elemental geometries of Limón in something completely different. A new and fresh breed of brass taps that communicate its structure and intended use with unusual honesty and clarity. Limón is available for every functional need in a great variety of finishes, chrome, burnished and brushed, natural brushed brass or matt black-coated.

L'incontro e l'unione con la propria sezione circolare, come nella tradizione dell'innesto agricolo, trasforma le geometrie apparentemente elementari di Limón in qualcosa di completamente diverso. Una nuova e fresca tipologia di rubinetti in ottone che comunica la propria struttura e la destinazione d'uso con inusuale onestà e chiarezza. Limón è disponibile per ogni esigenza funzionale in una grande varietà di finiture, cromata, brunito spazzolata, ottone naturale spazzolato o verniciata in nero opaco.

design Patricia Urquiola, 2021



Washbasin single hole mixer tap /
Miscelatore lavabo monoforo

Limón

Taps / Rubinetti



Washbasin single hole mixer tap /
Miscelatore lavabo monoforo



Washbasin three hole mixer tap /
Miscelatore lavabo tre fori



Wall-mounted three hole washbasin mixer tap /
Miscelatore lavabo tre fori da parete

Limón

Taps / Rubinetti



Thermostatic bathtub taps set / Gruppo termostatico per vasca

Limón

Taps / Rubinetti

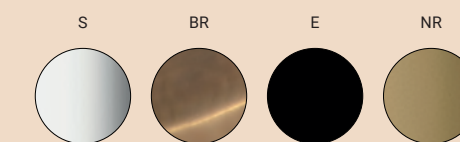

Washbasin taps / Gruppi lavabo

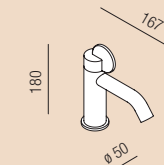
ALIM411D

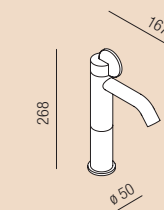

Washbasin single hole mixer tap, with flexible water main connection hoses / Miscelatore lavabo monoforo, con flessibili di alimentazione

ALIM412D



Washbasin single hole mixer tap, with flexible water main connection hoses / Miscelatore lavabo monoforo, con flessibili di alimentazione

ALIM413D

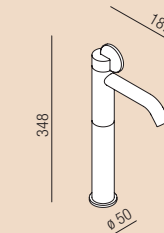

Washbasin single hole mixer tap, with flexible water main connection hoses / Miscelatore lavabo monoforo, con flessibili di alimentazione

ALIM415D

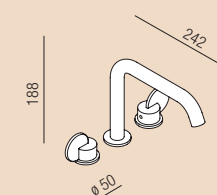

Washbasin tap set designed to fit three holes with double control and flexible water main connection hoses / Gruppo a tre fori con doppio comando e flessibili di alimentazione, per lavabo

.ELIM414D + .ILIX414D

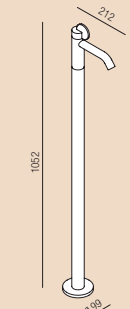

Floor mounted single hole lever mixer for washbasin / Miscelatore monoforo per lavabo, predisposto per fissaggio a pavimento

.EMEM323 + .IMEM327

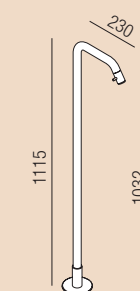

Floor standing spout with flow regulator. Temperature regulation is not managed. H 111,5 cm / Bocca di erogazione a pavimento con regolatore di flusso. Senza regolazione di temperatura. H cm 111,5

.ELIM422 + .ILIX420

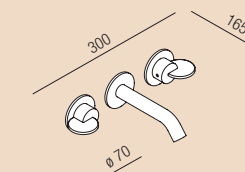

Built-in washbasin tap with dual control / Gruppo lavabo da incasso a doppio comando

.ELIM432D + .ILIX431D

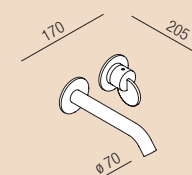

Built-in washbasin mixer tap / Miscelatore ad incasso per lavabo

Bidet taps / Gruppi bidet

ALIM416D

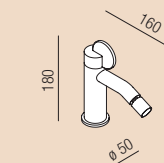

Single hole mixer tap for bidet, with flexible water main connection hoses / Miscelatore per bidet monoforo, con flessibili di alimentazione

Limón

Taps / Rubinetti

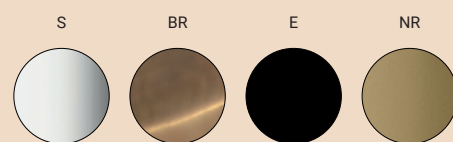

Bathtub taps / Gruppi vasca

.ELIM437D + .ILIX431D

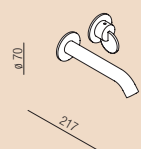

Built-in bathtub mixer /
Miscelatore ad incasso
per vasca

.ELIM443 + .ILIX443

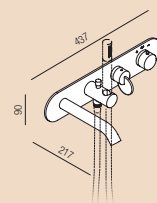

**Thermostatic bathtub taps
set with diverter and hand
held shower support** / Gruppo
termostatico ad incasso per
vasca, con deviatore e supporto
per doccetta

.ELIM425 + .ILIX425

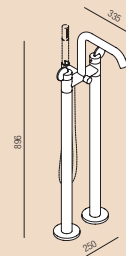

**Floor mounted bathtub tap with
dual control, flow deviator and
water connection for hand-held
shower** / Gruppo vasca a doppio
comando con deviatore e presa
d'acqua per doccetta, fissaggio
a pavimento

Limón

Taps / Rubinetti

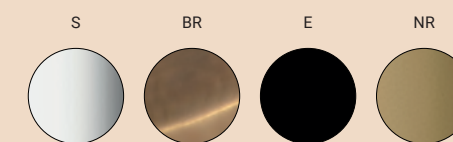

.ELIM436D + .ILIX436D

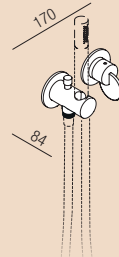

**Built-in single lever tap
unit with flow deviator and
hand-held shower holder** /
Miscelatore monocomando
ad incasso con deviatore e
supporto per doccetta

.ELIM441 + .ILIX441

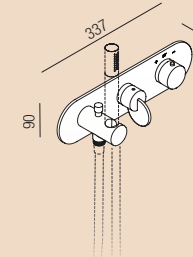

**Built-in thermostatic tap unit
with flow deviator and hand-
held shower holder** / Comando
termostatico ad incasso con
deviatore e supporto per
doccetta

Wc control plaque / Placca per controllo WC

ARUB0968N

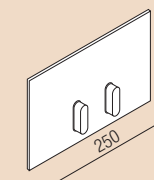

**Control plaque for recessed flush
tank with dual flushing capacity;
available in stainless steel** /
Placca comando di risciacquo
per cassetta ad incasso, con due
differenti quantità di risciacquo, in
acciaio inox

.EMEM327 + .IMEM327

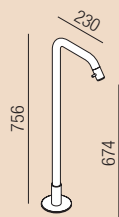

**Floor standing spout with
flow regulation. Temperature
regulation not managed** / Bocca
di erogazione a pavimento con
regolatore di flusso, regolazione
di temperatura non gestita

Bathtub, shower taps / Gruppi vasca, doccia

.ELIM430D + .ILIX430D



Built-in mixer tap / Miscelatore
monocomando ad incasso

.ELIM440D + .ILIX440D



Stop tap / Rubinetto d'arresto

.ELIX450 + .ILIX450

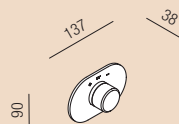

Built-in thermostatic valve /
Comando termostatico
ad incasso

.ELIM451 + .ILIX451

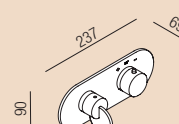

**Built-in thermostatic set with
flow regulation with single
output** / Comando termostatico
ad incasso con regolazione di
flusso ad una uscita

.ELIM452 + .ILIX452

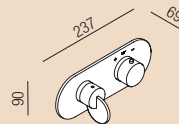

**Built-in thermostatic set
with flow regulation with
two outputs** / Comando
termostatico ad incasso con
regolazione di flusso a due
uscite

.ELIM435D + .ILIX435D

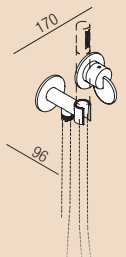

**Built-in single tap unit and
hand-held shower holder** /
Miscelatore monocomando ad
incasso con supporto
per doccetta

Memory Mix

Taps / Rubinetti

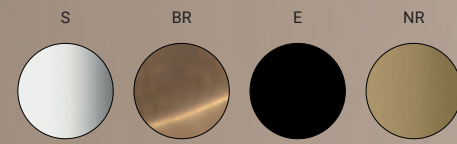

Brass taps with different finishes featured by the new lever that takes its shape directly from the iconic cross handle of the Memory series. The new single lever is twice as long as a "conventional" Memory handle arm. Its width has been adjusted and slightly enlarged to be ergonomically consistent with the new usage model.

Rubineria in ottone con diverse finiture caratterizzata dalla nuova leva che prende la sua forma direttamente dall'iconica maniglia a croce della serie Memory. La nuova leva singola è lunga il doppio di un braccio dell'impugnatura Memory "convenzionale". La sua larghezza è stata regolata e leggermente allargata per essere ergonomicamente coerente con il nuovo modello di utilizzo.

design Benedini Associati, 2021



Washbasin single hole mixer tap /
Miscelatore lavabo monoforo

Memory Mix

Taps / Rubinetti



Built-in single lever tap unit with flow deviator and hand-held shower holder / Miscelatore monocomando ad incasso con deviatore e supporto per doccia

Memory Mix

Taps / Rubinetti



Wall-mounted three hole washbasin mixer tap /
Miscelatore lavabo tre fori da parete



Washbasin single hole mixer tap /
Miscelatore lavabo monoforo



Washbasin three hole mixer tap /
Miscelatore lavabo tre fori

Memory Mix

Taps / Rubinetti

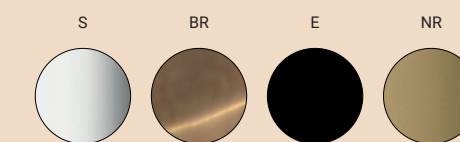

Washbasin taps / Gruppi lavabo

AMIX411D

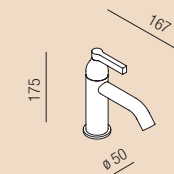

Washbasin single hole mixer tap, with flexible water main connection hoses / Miscelatore lavabo monoforo, con flessibili di alimentazione

AMIX412D

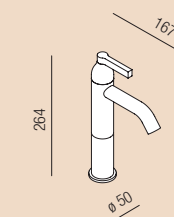

Washbasin single hole mixer tap, with flexible water main connection hoses / Miscelatore lavabo monoforo, con flessibili di alimentazione

AMIX413D

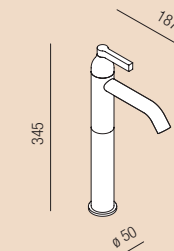

Washbasin single hole mixer tap, with flexible water main connection hoses / Miscelatore lavabo monoforo, con flessibili di alimentazione

AMIX415D

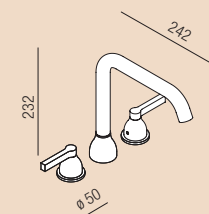

Washbasin tap set designed to fit three holes with double control and flexible water main connection hoses / Gruppo lavabo a tre fori con doppio comando e flessibili di alimentazione

.EMIX414D + .ILIX414D



Floor mounted single hole lever mixer for washbasin / Miscelatore monoforo per lavabo, predisposto per fissaggio a pavimento

.EMEM323 + .IMEM327

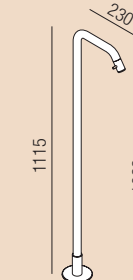

Floor standing spout with flow regulator. Temperature regulation is not managed. H 111,5 cm / Bocca di erogazione a pavimento con regolatore di flusso. Senza regolazione di temperatura. H cm 111,5

.EMIX422 + .ILIX420

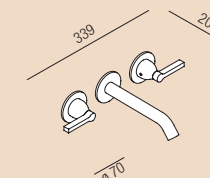

Built-in washbasin tap with dual control / Gruppo lavabo da incasso a doppio comando

.EMIX432D + .ILIX431D

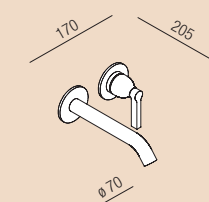

Built-in washbasin mixer tap / Miscelatore ad incasso per lavabo

Bidet taps / Gruppi bidet

AMIX416D

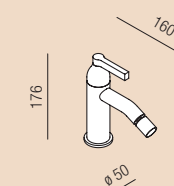

Single hole mixer tap for bidet, with flexible water main connection hoses / Miscelatore per bidet monoforo, con flessibili di alimentazione

Memory Mix

Taps / Rubinetti

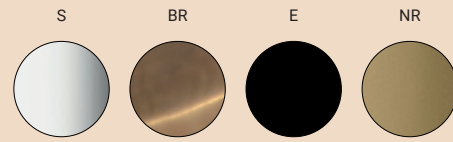

Bathtub taps / Gruppi vasca

.EMIX437D + .ILIX431D

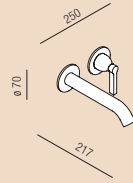

Built-in bathtub mixer /
Miscelatore ad incasso per
vasca

.EMIX443 + .ILIX443

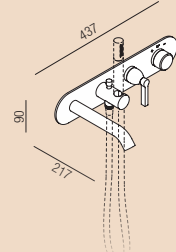

**Thermostatic bathtub tap set
with diverter and hand held
shower support** / Gruppo
termostatico ad incasso per
vasca, con deviatore e supporto
per doccia

.EMIX425 + .ILIX425

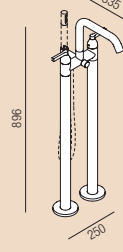

**Floor mounted bathtub tap with
dual control, flow deviator and
water connection for hand-held
shower** / Gruppo per vasca a
doppio comando con deviatore
e presa d'acqua per doccia,
predisposto per fissaggio a
pavimento

Memory Mix

Taps / Rubinetti



.EMIX436D + .ILIX436D

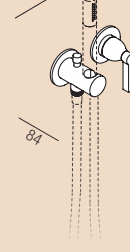

**Built-in single lever tap
unit with flow deviator and
hand-held shower holder** /
Miscelatore monocomando
ad incasso con deviatore e
supporto per doccia

.EMIX441 + .ILIX441

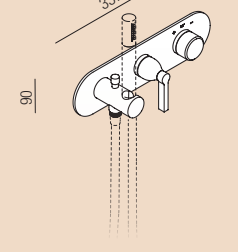

**Built-in thermostatic tap unit
with flow deviator and hand-
held shower holder** / Comando
termostatico ad incasso con
deviatore e supporto per doccia

Wc control plaque / Placca per controllo WC

ARUB0968N

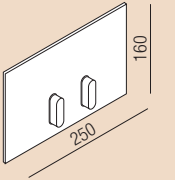

**Control plaque for recessed flush
tank with dual flushing capacity;
available in stainless steel** /
Placca comando di risciacquo
per cassetta ad incasso, con due
differenti quantità di risciacquo, in
acciaio inox

.EMEM327 + .IMEM327

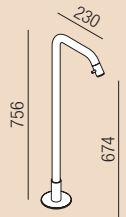

**Floor standing spout with
flow regulation. Temperature
regulation not managed**
/ Bocca di erogazione a
pavimento con regolatore
di flusso, regolazione di
temperatura non gestita

Bathtub, shower taps / Gruppi vasca, doccia

.EMIX430D + .ILIX430D

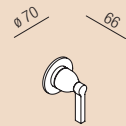

Built-in mixer tap / Miscelatore
monocomando ad incasso

.EMIX440D + .ILIX440D

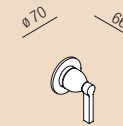

Stop tap / Rubinetto d'arresto

.ELIX450 + .ILIX450

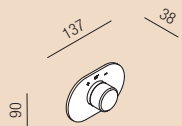

Built-in thermostatic valve /
Comando termostatico ad incasso

.EMIX451 + .ILIX451

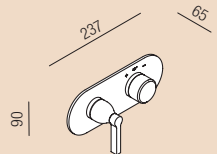

**Built-in thermostatic set with
flow regulation with single
output** / Comando termostatico
ad incasso con regolazione di
flusso ad una uscita

.EMIX452 + .ILIX452

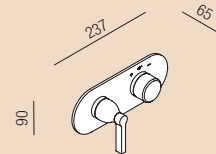

**Built-in thermostatic set with
flow regulation with two outputs**
/ Comando termostatico ad
incasso con regolazione di flusso
a due uscite

.EMIX435D + .ILIX435D

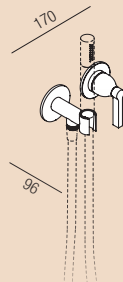

**Built-in single lever tap unit
and hand-held shower holder**
/ Miscelatore monocomando
ad incasso con supporto per
doccia

